

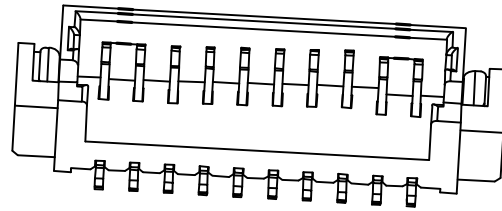

REV.	ECN NO OR DESCRIPTION	REVISED	DATE

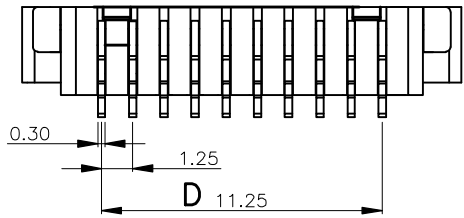

3D VIEW

Specifications:

1. Rated Voltage : 125V AC/DC
2. Rated Current : 1A AC,DC
3. Withstand Voltage : 200V AC/minute
4. Contact Resistance : 50mΩ(MAX.)
5. Insulation Resistance : 100MΩ(MIN.)
6. Storage Temperature Range: -40°C~+85°C;
7. Operation Temperature Range: -25°C~+70°C;

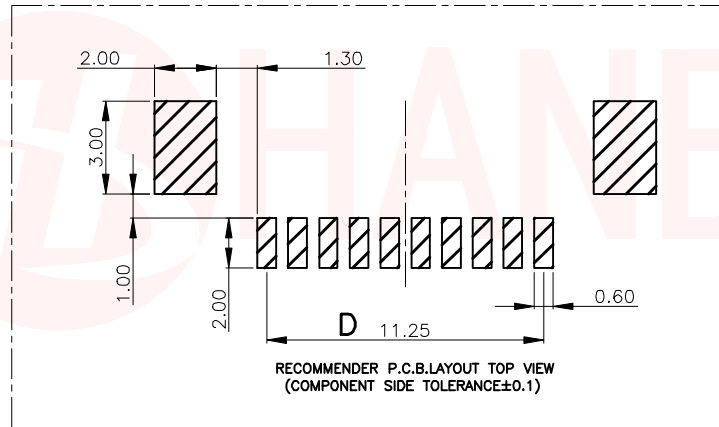
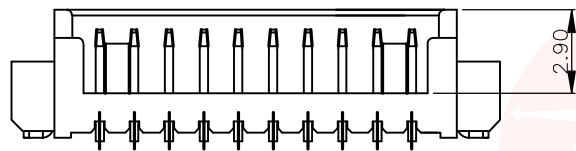

RECOMMENDER P.C.B.LAYOUT TOP VIEW
(COMPONENT SIDE TOLERANCE±0.1)

PIN数	A±0.1	B±0.1	C±0.1	D±0.1
2A	7.50	3.20	4.50	1.25
3A	8.75	4.45	5.75	2.50
4A	10.00	5.70	7.00	3.75
5A	11.25	6.95	8.25	5.00
6A	12.50	8.20	9.50	6.25
7A	13.75	9.45	10.75	7.50
8A	15.00	10.70	12.00	8.75
9A	16.25	11.95	13.25	10.00
10A	17.50	13.20	14.50	11.25

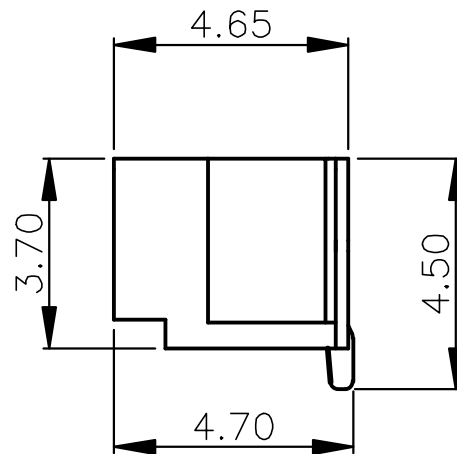
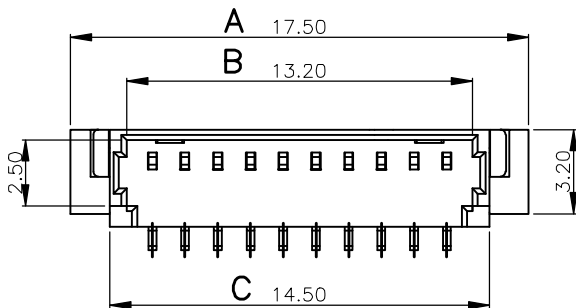
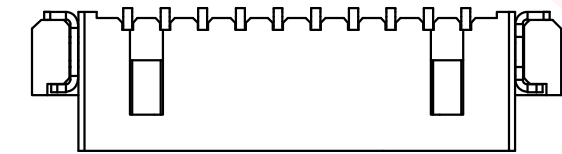

3	插片	黄铜H65	镀镍锡	
2	插针	黄铜H65	镀镍锡	
1	基座	LCP	本色	
序号	品名	材质	电镀/颜色	备注

UNLESS OTHERWISE SPECIFIED TOLERANCES



东莞市汉博电子科技有限公司
DONGGUAN HANBO TECHNOLOGY CO., LTD

DECIMALS: X :±0.25 X.X :±0.15 X.XX :±0.05
ANGLES: X :±2° X.X :±1°

TITLE	WAFER 1.25贴片			
DWN	xiong	PART NO. WAFER-125L-NA		
CHKD	lee	SCALE:1:1	UNIT: mm	
APVD	wang	SIZE: A4	SHEET:1OF 1	REV: A4

CUSTOMER COPY

X-ON Electronics

Largest Supplier of Electrical and Electronic Components

Click to view similar products for [Headers & Wire Housings](#) category:

Click to view products by [Hanbo Electronic](#) manufacturer:

Other Similar products are found below :

[57102-F02-18ULF](#) [58102-G61-06LF](#) [0009485154](#) [009176003701906](#) [0050291907](#) [00-9021-0611-00-339](#) [02.125.8002.8](#) [609-3404](#) [61062-3](#)
[622-0430](#) [622-3653LF](#) [63453-116](#) [636-1030](#) [636-1427](#) [636-3427](#) [636-4007](#) [641938-9](#) [644827-2](#) [65495-038](#) [65692-001LF](#) [65781-018](#)
[65781-047](#) [65817-010LF](#) [65817-015LF](#) [66207-023LF](#) [67016-026LF](#) [67095-007LF](#) [68631-112](#) [68645-018](#) [68648-049](#) [699319-000](#)
[70.362.1628.0](#) [70-4210](#) [70-4226B](#) [70-4853B](#) [707-5020](#) [707-5028](#) [71.350.2428.0](#) [71961-016LF](#) [733-134](#) [754199-000](#) [760-3052](#) [787-8014-00](#)
[FCN-367T-T012/H](#) [80.063.4001.1](#) [800-90-001-10-001000](#) [800-90-010-10-002000](#) [801-43-002-10-013000](#) [801-43-006-10-002000](#)
[803-41-018-10-001000](#)