

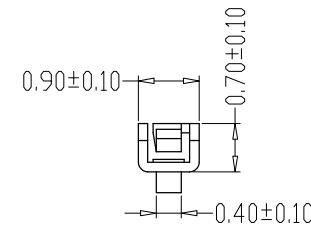

REV.	ECN NO OR DESCRIPTION	REVISED	DATE

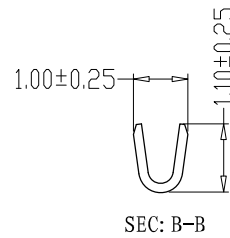
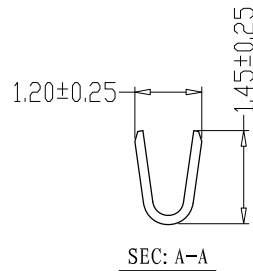
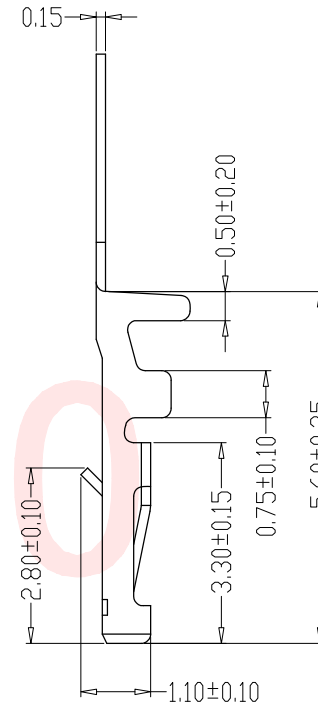
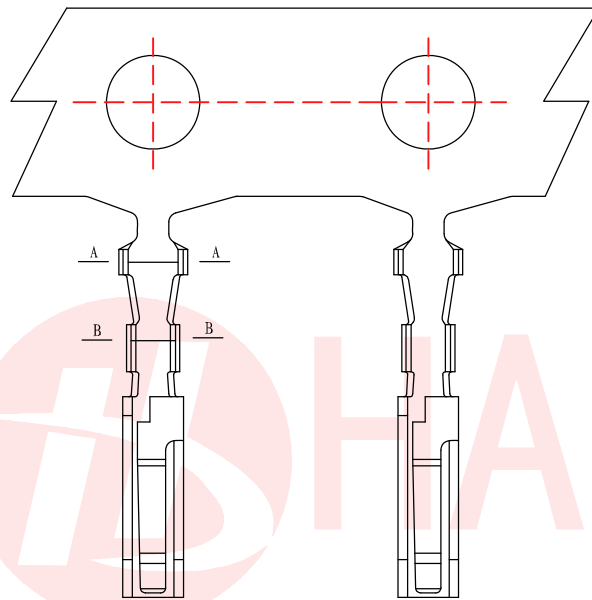

**SPECIFICATIONS**

- 1、Current Rating: 1A AC, DC
- 2、Voltage Rating: 125V AC, DC
- 3、Temperatuer Range: -25°C~+85°C
- 4、Contact Resistance: 20mΩ Max
- 5、Insulation Resistance: 100MΩ Min
- 6、Withstanding Voltang: 500V AC/minute
- 7、Material:Phosphoric bronze Gold-plated
- 8、Applicable Wire Sizes:AWG#28~32#

UNLESS OTHERWISE SPECIFIED TOLERANCES		东莞市汉博电子科技有限公司 DONGGUAN HANBO TECHNOLOGY CO., LTD			
DECIMALS:	ANGLES:	TITLE	WAFER MX 1.25超薄端子		
X :±0.20	X :±2°	DWN	xiong	PART NO. WAFER-MX125CB-DZ	
X.X :±0.10	X.X :±1°	CHKD	lee	SCALE:1:1	UNIT: mm
X.XX :±0.05		APVD	wang	SIZE: A4	SHEET:10F 1
		REV: A4			
CUSTOMER COPY					



REV.	ECN NO OR DESCRIPTION	REVISED	DATE

### SPECIFICATIONS

- 1、Current Rating: 1A AC, DC
- 2、Voltage Rating: 125V AC, DC
- 3、Temperatuer Range: -25°C~+85°C
- 4、Contact Resistance: 20mΩ Max
- 5、Insulation Resistance: 100MΩ Min
- 6、Withstanding Voltang: 500V AC/minute
- 7、Material:PBT, UL94V-0

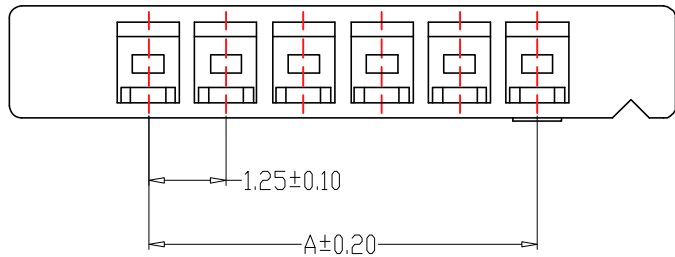
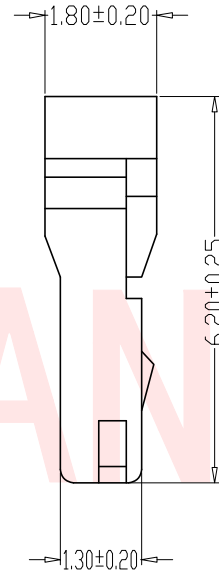
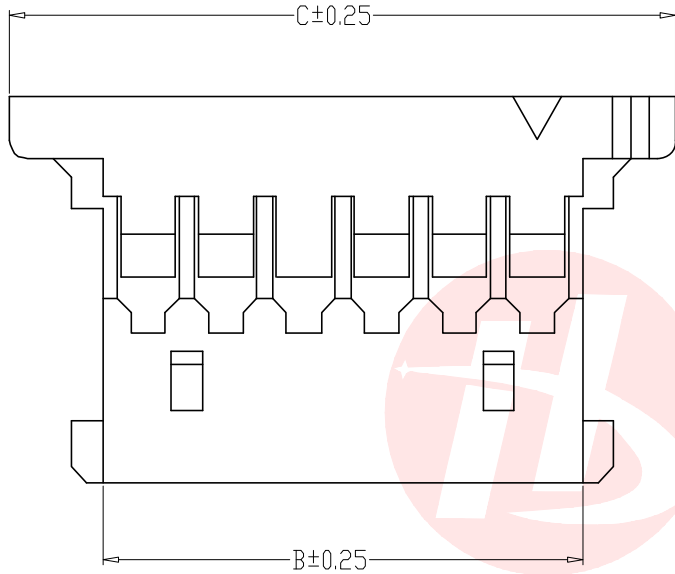

### TABLE:

CSG PART NO.	PIN位	A	B	C
WAFER-MX125CB-JK-2A	2PIN	1.25	2.72	5.72
WAFER-MX125CB-JK-3A	3PIN	2.50	3.97	6.97
WAFER-MX125CB-JK-4A	4PIN	3.75	5.22	8.22
WAFER-MX125CB-JK-5A	5PIN	5.00	6.47	9.47
WAFER-MX125CB-JK-6A	6PIN	6.25	7.72	10.72
WAFER-MX125CB-JK-7A	7PIN	7.50	8.97	11.97
WAFER-MX125CB-JK-8A	8PIN	8.75	10.22	13.22
WAFER-MX125CB-JK-9A	9PIN	10.00	11.47	14.47
WAFER-MX125CB-JK-10A	10PIN	11.25	12.72	15.72
WAFER-MX125CB-JK-11A	11PIN	12.50	13.97	16.97
WAFER-MX125CB-JK-12A	12PIN	13.75	15.22	18.22
WAFER-MX125CB-JK-30A	20PIN	36.25	37.72	40.72

UNLESS OTHERWISE SPECIFIED TOLERANCES

DECIMALS: ANGLES:  
 X :±0.20 X :±2°  
 X.X :±0.10 X.X :±1°  
 X.XX :±0.05



东莞市汉博电子科技有限公司  
 DONGGUAN HANBO TECHNOLOGY CO., LTD

TITLE	WAFER MX 1.25超薄 胶壳		
DWN	xiong	PART NO. WAFER-MX125CB-JK-NA	
CHKD	lee	SCALE:1:1	UNIT: mm
APVD	wang	SIZE: A4	SHEET:10F 1

CUSTOMER COPY



REV.	ECN NO OR DESCRIPTION	REVISED	DATE

**SPECIFICATIONS**

- 1、Current Rating: 1A AC, DC
- 2、Voltage Rating: 125V AC, DC
- 3、Temperatuer Range: -25°C~+85°C
- 4、Contact Resistance: 20mΩ Max
- 5、Insulation Resistance: 100MΩ Min
- 6、Withstanding Voltang: 500V AC/minute
- 7、Material: Wafer Nylon6T, UL94V-0

PIN Phosphoric bronze Tin-plated  
Solder tads Phosphoric bronze Tin-plated

**TABLE:**

CSG PART NO.	Dimension mm		
	A	B	C
WAFER-MX125CB-WT-2A	1.25	7.65	3.05
WAFER-MX125CB-WT-3A	2.50	8.90	4.30
WAFER-MX125CB-WT-4A	3.75	10.15	5.55
WAFER-MX125CB-WT-5A	5.00	11.40	6.80
WAFER-MX125CB-WT-6A	6.25	12.65	8.05
WAFER-MX125CB-WT-7A	7.50	13.90	9.30
WAFER-MX125CB-WT-8A	8.75	15.15	10.55
WAFER-MX125CB-WT-9A	10.00	16.40	11.80
WAFER-MX125CB-WT-10A	11.25	17.65	13.05
WAFER-MX125CB-WT-11A	12.50	18.90	14.30
WAFER-MX125CB-WT-12A	13.75	20.15	15.55
WAFER-MX125CB-WT-13A	15.00	21.40	16.80
WAFER-MX125CB-WT-14A	16.25	22.65	18.05
WAFER-MX125CB-WT-15A	17.50	23.90	19.30
WAFER-MX125CB-WT-16A	18.75	25.15	20.55

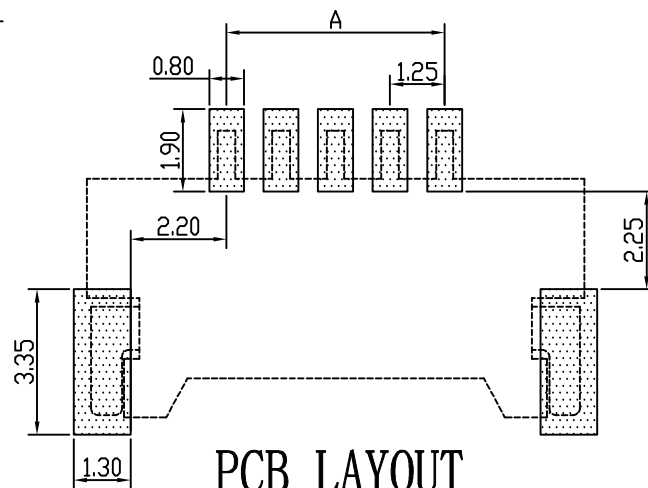
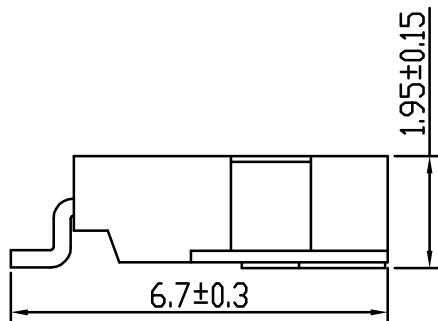
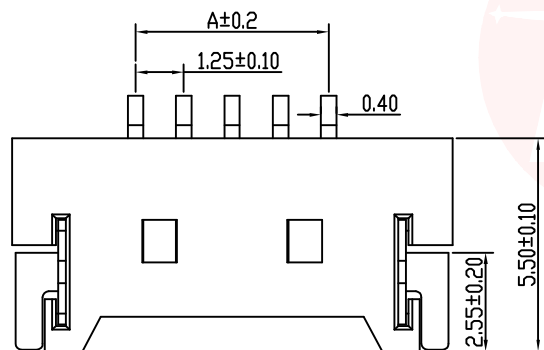
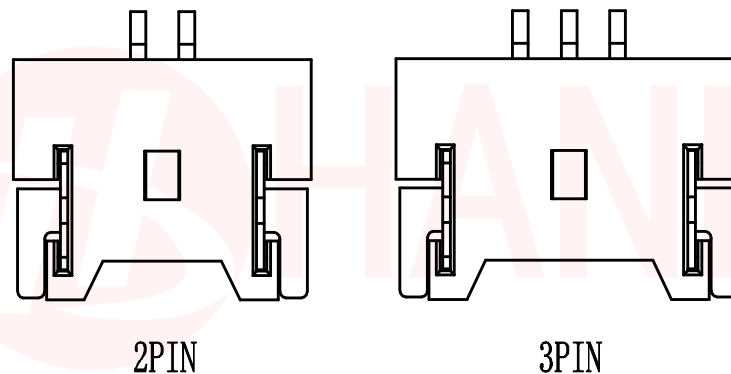
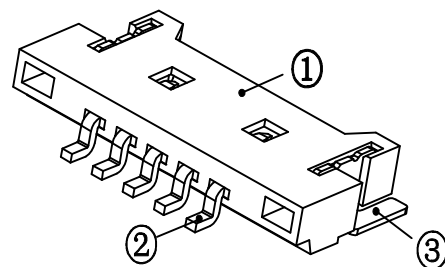
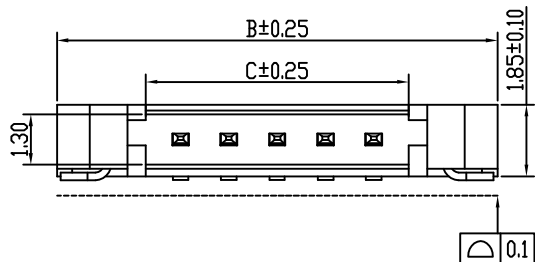

UNLESS OTHERWISE SPECIFIED TOLERANCES

DECIMALS: X ±0.20 X.X ±0.10 X.XX ±0.05  
 ANGLES: X ±2° X.X ±1°



东莞市汉博电子科技有限公司  
DONGGUAN HANBO TECHNOLOGY CO., LTD

TITLE	WAFER MX 1.25 超薄镀金 SMT TYPE		
DWN	xiong	PART NO.	WAFER-MX125CB-WT-NA
CHKD	lee	SCALE:1:1	UNIT: mm
APVD	wang	SIZE: A4	SHEET:10F 1

CUSTOMER COPY

## X-ON Electronics

Largest Supplier of Electrical and Electronic Components

*Click to view similar products for [Headers & Wire Housings](#) category:*

*Click to view products by [Hanbo Electronic](#) manufacturer:*

Other Similar products are found below :

[0015917161](#) [0022155065](#) [57102-F02-18ULF](#) [58102-G61-06LF](#) [582553-1](#) [01.001.5753.1](#) [0050291907](#) [02.125.8002.8](#) [609-3404](#) [61062-3](#)  
[CSU011177004](#) [622-0430](#) [622-3653LF](#) [63453-116](#) [636-1030](#) [636-1427](#) [636-3427](#) [636-4007](#) [641938-9](#) [65495-038](#) [65692-001LF](#) [65781-018](#)  
[65781-047](#) [65817-010LF](#) [65817-015LF](#) [67095-007LF](#) [67601157](#) [68631-112](#) [68645-018](#) [699319-000](#) [70.362.1628.0](#) [70-4210](#) [70-4226B](#) [70-](#)  
[4853B](#) [71.350.2428.0](#) [733-134](#) [733-162](#) [760-3052](#) [MHR-64-VUAL](#) [80.063.4001.1](#) [800-90-001-10-001000](#) [801-43-002-10-013000](#)  
[801-43-006-10-002000](#) [803-43-024-10-001000](#) [803-93-012-10-001000](#) [8-1437020-4](#) [819-22-004-30-001101](#) [820-22-006-30-001101](#)  
[820-22-008-30-001101](#) [821-22-002-10-001101](#)