

Specifications:

1. Electrical:

- 1.1 Current Rating: 1.8A/contact terminal
- 1.2 Voltage Rating: 30V DC
- 1.3 Contact Resistance: 50 milliohms Max
- 1.4 Dielectric Withstanding Voltage: 300 V AC AT Sea Level
- 1.5 Insulation resistance: 100MEGA ohms MIN

2. Mechanical:

- 2.1 Connector Mate and Unmate Force: Mate force: 3.0kgf (Max) Unmate force: 0.7kgf (MIN)
- 2.2 Durability: 2000 cycles

3. Material:

- 3.1 Housing: High Temperature Thermoplastics, U1 94V-0 LCP Black
- 3.2 Contact: C5191-EH
- 3.3 Shell: H65 EHO.3MM

4. PLATING

- 4.1 Contact: Plated Gold in Mating Area; Tin On Solder Tails
- 4.2 Shell: Nickel 50u" Min Plated.

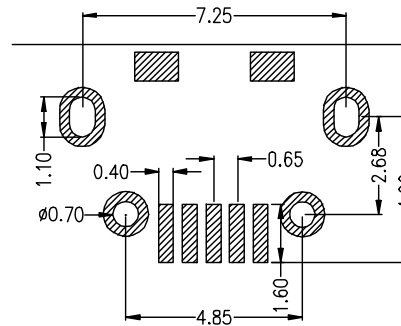
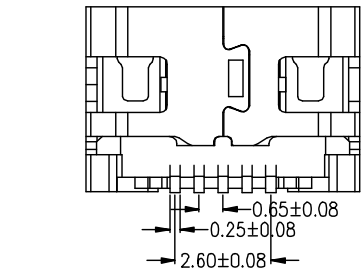
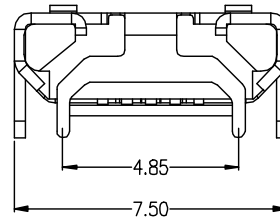
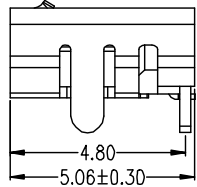
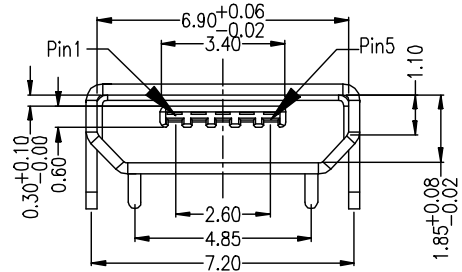

05XX-4BH23-X
 1:AU 1U"
 6:AU 30U"
 T:TIN
 N:NICKEL
 S:Scrolls F:Flat

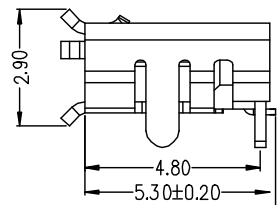
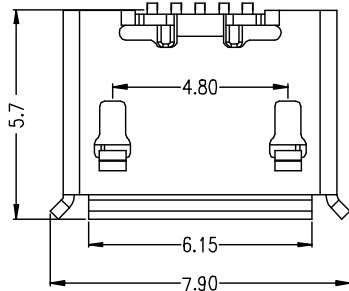

S:Scrolls

new		2015/5/3	A	瀚源	
ECN BO.		DATE.	REV.		
DESIGNED	CHECKED	APPROVAL	DRAWING NUMBER	SCALT: 1/2	SCALE: 3:1
Mikey	Tom	Jerry	PART NAME 05XX-4BH23-X	UNLESS OTHERWISE SPECIFIED, TOLERANCE:	X. ±0.25
			MODEL NAME 05XX-4BH23-X		X.x ±0.20
3RD ANGLE PROJ			HanElectricity Co.,LTD	ANGULAIR	X.xx ±0.15
				FILE.NO.	±3

X-ON Electronics

Largest Supplier of Electrical and Electronic Components

Click to view similar products for [USB Connectors](#) category:

Click to view products by [HanElectricity](#) manufacturer:

Other Similar products are found below :

[950](#) [MUSBD11135](#) [17-200721](#) [217450-1](#) [KMBVX-TH-5S-B30](#) [KUSBX-AS2N-W](#) [KUSBX-SMT2AP1S-W30](#) [935](#) [957](#) [30-498-6](#) [SK-60A-2](#)
[1734082-1](#) [30-470](#) [30-489](#) [30-541](#) [A-USB A-2P-C](#) [MIKROE-1451](#) [USBFTVSCCG](#) [1-1734084-2](#) [10135326-001LF](#) [4198](#) [USB-A-D-VT](#)
[USB-A-S-RA-TSMT](#) [1310-1023-02](#) [690-024-633-031](#) [UB-20PMFP-LC7001](#) [17-200011](#) [UB-20AFMM-LL7A01](#) [1040870124](#) [CAP-](#)
[WCCMLPB1](#) [CAP-WCCMLPC1](#) [2274475-3](#) [UB-20BMFA-SL8001](#) [914-614A2025S10200](#) [USB3FTV7SAGF059](#) [ZX40-B-5S-1500-](#)
[STDA\(30\)](#) [GSB3116344HR](#) [USB3FTV2SAZNF459](#) [USB3FTV7SAZNF459](#) [U221-041N-1WVS62-F5D](#) [HYCW153-USBD05-500B](#)
[HYCW219-USBD05-075B](#) [HYCW148-USBD05-117B](#) [HYCW149-USBD05-740B](#) [HYCW204-USBD05-108B](#) [HYCW214-USBA04-113B](#)
[HYCW213-USBA04-113B](#) [UB-20AMFM-SL7A01](#) [KMMX-BSMT35S-1-B30TR](#) [2345986-1](#)