

Electrical Characteristics:

Current rating:0.5A AC/DC

Voltage rating:50V AC/DC

Temperature range: -25℃~+85℃

Withstand Voltage:200V AC/DC Minute

Contact Resistance: ≤30mΩ

Insulation resistance: ≥500MΩ

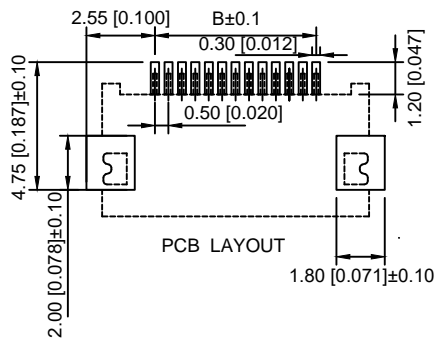
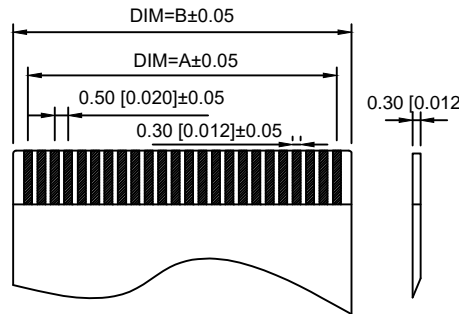
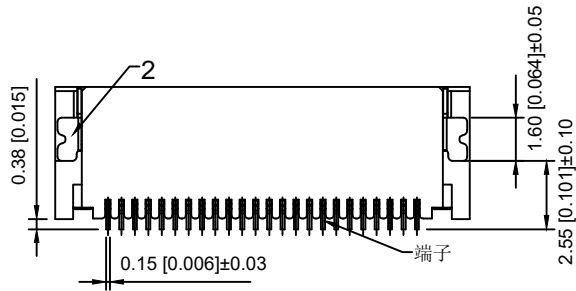
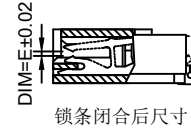
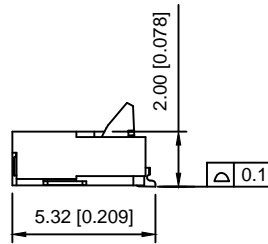
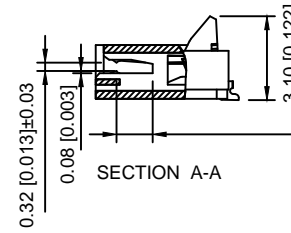
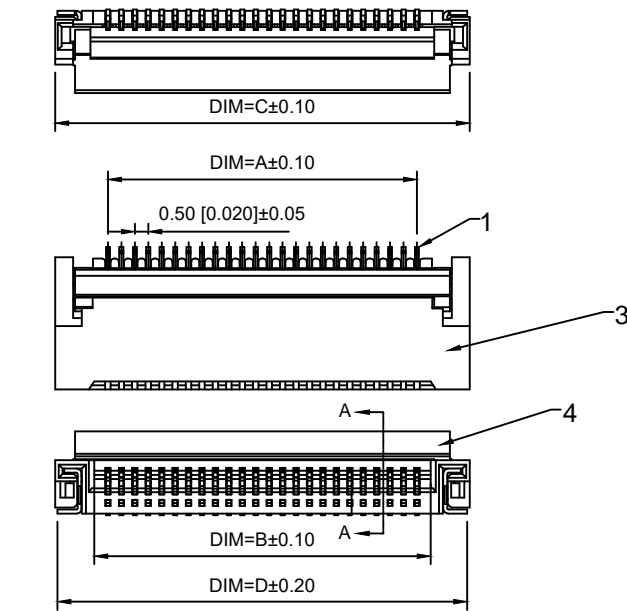

编号	尺寸 (mm)					编号	尺寸 (mm)				
	A	B	C	D	E		A	B	C	D	E
4	1.50	2.52	5.45	5.25		35	17.00	18.02	20.95	20.75	
5	2.00	3.02	5.95	5.75		36	17.50	18.52	21.45	21.25	
6	2.50	3.52	6.45	6.25		37	18.07	19.02	21.95	21.75	
7	3.00	4.02	6.95	6.75		38	18.50	19.52	22.45	22.25	
8	3.50	4.52	7.45	7.25		39	19.00	20.02	22.95	22.75	
9	4.00	5.02	7.95	7.75		40	19.50	20.52	23.45	23.25	
10	4.50	5.52	8.45	8.25		41	20.00	21.02	23.95	23.75	
11	5.00	6.02	8.95	8.75		42	20.50	21.52	24.45	24.25	
12	5.50	6.52	9.45	9.25		43	21.00	22.02	24.95	24.75	0.18
13	6.02	7.02	9.95	9.75		44	21.50	22.52	25.45	25.25	
14	6.50	7.52	10.24	10.25		45	22.00	23.02	25.95	25.75	
15	7.00	8.02	10.95	10.75		46	22.50	23.52	26.45	26.25	
16	7.50	8.52	11.45	11.25		47	23.00	24.02	26.95	26.75	
17	8.00	9.02	11.95	11.75		48	23.50	24.52	27.45	27.25	
18	8.50	9.52	12.45	12.25		49	24.00	25.02	27.95	27.75	
19	9.00	10.02	12.95	12.75		50	24.50	25.52	28.45	28.25	
20	9.50	10.52	13.45	13.25		51	25.10	26.02	28.95	28.75	
21	10.00	11.02	13.95	13.75		52	25.60	26.52	29.45	29.25	
22	10.50	11.52	14.45	14.25		53	26.10	27.02	29.95	29.75	
23	11.00	12.02	14.95	14.75		54	26.60	27.52	30.45	30.25	
24	11.50	12.52	15.45	15.25		55	27.10	28.02	30.95	30.75	0.20
25	12.00	13.02	15.95	15.75		56	27.50	28.52	31.45	31.25	
26	12.50	13.52	16.45	16.25		57	28.00	29.02	31.95	31.75	
27	13.00	14.02	16.95	16.75		58	28.50	29.52	32.45	32.25	
28	13.50	14.52	17.45	17.25		59	29.00	30.02	32.95	32.75	
29	14.00	15.02	17.95	17.75		60	29.50	30.52	33.45	33.25	
30	14.50	15.52	18.45	18.25							
31	15.00	16.02	18.95	18.75							
32	15.50	16.52	19.45	19.25							
33	16.00	17.02	19.95	19.75							
34	16.50	17.52	20.45	20.25							

序号	名称	材料	附注
1	端子	磷青铜	表面镀锡
2	焊片	磷青铜	表面镀锡
3	基座	LCP UL94V-0	本色
4	锁条	LCP UL94V-0	黑色

new		2015/5/3		A		瀚源
ECN BO.		DESCRIPTION.		DATE.		
DESIGNED	CHECKED	APPROVAL	DRAWING NUMBER	SCALT: 1/2		SCALE: 3:1
Mikey	Tom	Jerry	PART NAME	05A20HXX		UNLESS OTHERWISE SPECIFIED, TOLERANCE:
			MODEL NAME	H-05A20HXX		
			3RD ANGLE PROJ	HanElectricity Co.,LTD		

X. ±0.25
X.x ±0.20
X.xx ±0.15
ANGULAR ±3°

X-ON Electronics

Largest Supplier of Electrical and Electronic Components

Click to view similar products for [FFC & FPC Connectors](#) category:

Click to view products by [HanElectricity](#) manufacturer:

Other Similar products are found below :

[00-6200-227-022-800](#) [006205250500825+](#) [006205280500825+](#) [FPH-1602G](#) [086222026001800](#) [52610-0675](#) [62674-201121DLF](#) [52746-1671-TR250](#) [10051922-1610EHLF](#) [10051922-2810EHLF](#) [686322124422](#) [XF3M-2915-1B-R100](#) [AYF353125A](#) [AYF530665TA](#) [AYF534065TA](#) [20FLH-RSM1-TB](#) [PCA-7F-25-HL-3-G](#) [207356-1](#) [52807-0430](#) [FFC05011-10SBB114W5M](#) [502250-8027](#) [FH28K-40S-0.5SH](#) [200528-0260](#) [FH28K-10S-0.5SH](#) [501951-1250](#) [X05B20U43T](#) [0.5K-DX-30PWB](#) [DS1020-08-10VBT12](#) [THD0515-34CL-GF](#) [X05A10L28G](#) [ECC2841061EU](#) [20539-030E-01](#) [1.0K-DHQX-16PWB](#) [1.0K-DHQX-30PWB](#) [1775333-6](#) [10054365-202110ELF](#) [10054365-242110ELF](#) [10054365-282110ELF](#) [10064555-392220HLF](#) [59453-041110EBHLF](#) [59453-091110EDHLF](#) [62674-241141ALF](#) [62684-432100ALF](#) [62684-451100AHLF](#) [62684-5721N0ALF](#) [HFW11R-1STE1MTLF](#) [HFW12R-1STE9LF](#) [HFW14R-1STE9MTLF](#) [HFW18S-2STE9LF](#) [HFW20R-1STAE1HLF](#)