

Electrical Characteristics:
 Current rating:0.4A AC/DC
 Voltage rating:50V AC/DC
 Temperature range: -25°C~+85°C
 Withstand Voltage:200V AC/Minute
 Contact Resistance: ≤20mΩ
 Insulation resistance: ≥500MΩ

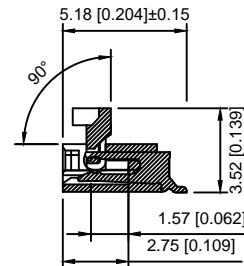

SECTION A-A

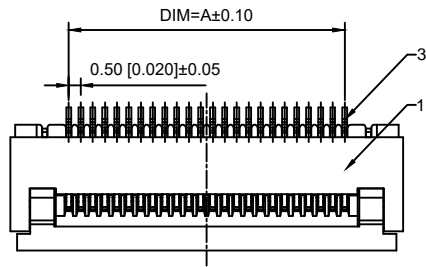
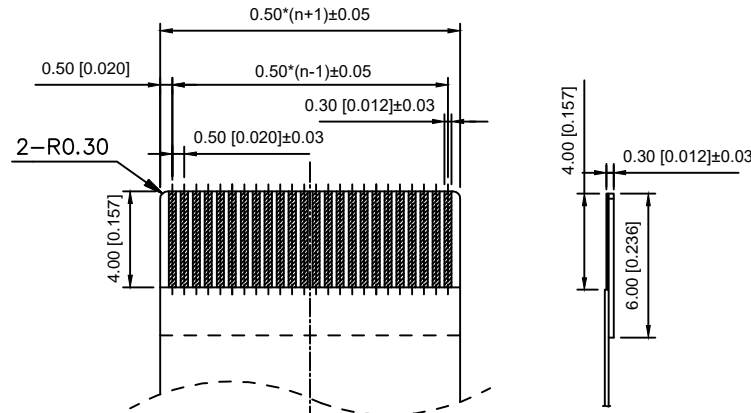
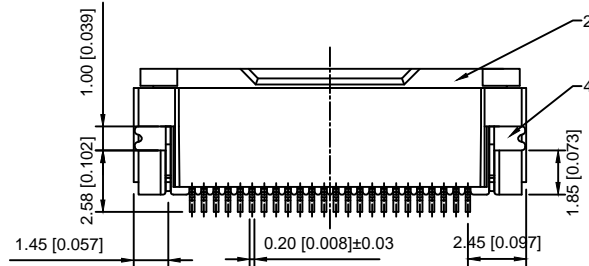
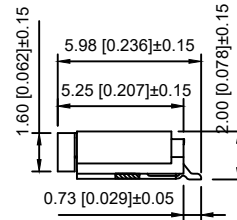
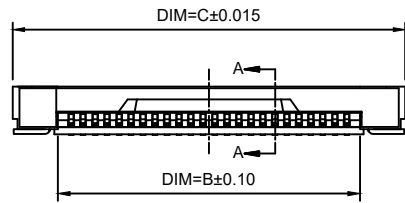

适用扁平线

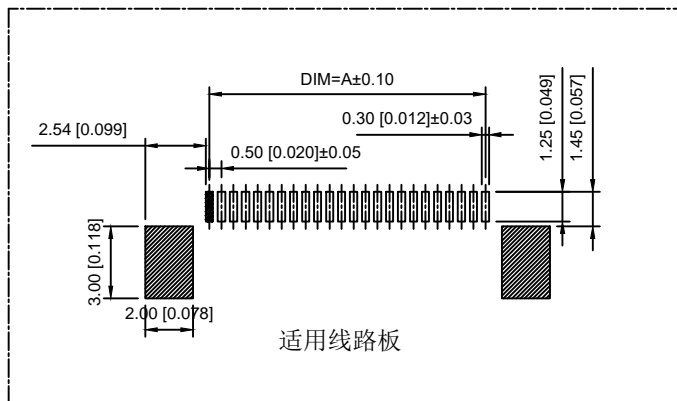

适用线路板

编号	尺寸 (mm)			编号	尺寸 (mm)		
	A	B	C		A	B	C
4	1.50	2.59	6.39	35	17.03	18.12	21.92
5	2.00	3.09	6.89	36	17.53	18.62	22.42
6	2.50	3.59	7.39	37	18.03	19.12	22.92
7	3.00	4.09	7.89	38	18.53	19.62	23.42
8	3.50	4.59	8.39	39	19.03	20.12	23.92
9	4.00	5.09	8.89	40	19.53	20.62	24.42
10	4.50	5.59	9.39	41	20.04	21.12	24.92
11	5.01	6.09	9.89	42	20.54	21.62	25.42
12	5.51	6.59	10.39	43	21.04	22.12	25.92
13	6.01	7.09	10.89	44	21.54	22.63	26.43
14	6.51	7.60	11.40	45	22.04	23.13	26.93
15	7.01	8.10	11.90	46	22.54	23.63	27.43
16	7.51	8.60	12.40	47	23.04	24.13	27.93
17	8.01	9.10	12.90	48	23.54	24.63	28.43
18	8.51	9.60	13.40	49	24.04	25.13	28.93
19	9.01	10.10	13.90	50	24.54	25.63	29.43
20	9.51	10.80	14.40	51	25.05	26.13	29.93
21	10.02	11.10	14.90	52	25.55	26.63	30.43
22	10.52	11.60	15.40	53	26.05	27.13	30.93
23	11.02	12.10	15.90	54	26.55	27.64	31.44
24	11.52	12.61	16.41	55	27.05	28.14	31.94
25	12.02	13.11	17.91	56	27.55	28.64	32.44
26	12.52	13.61	17.41	57	28.05	29.14	32.94
27	13.02	14.11	17.91	58	28.55	29.64	33.44
28	13.52	14.61	18.41	59	29.05	30.14	33.94
29	14.02	15.11	18.91	60	29.55	30.64	34.44
30	14.52	15.61	19.41				
31	15.03	16.11	19.91				
32	15.53	16.61	20.41				
33	16.03	17.11	20.91				
34	16.53	17.62	21.42				

序号	名称	数量	材料	附注
1	塑件	1	LCP	本色
2	锁扣	1	LCP	黑色
3	插簧	N	磷铜	镍底, 高亚锡
4	焊片	2	磷铜	镍底, 高亚锡

ECN BO.		new		2015/5/3		A		瀚源	
DESIGNED	CHECKED	APPROVAL	DRAWING NUMBER	DATE.	REV.	SCALE: 1/2	SCALE: 3:1		
Mikey	Tom	Jerry	PART NAME	05A20LXX	UNLESS OTHERWISE SPECIFIED, TOLERANCE:	X.	±0.25	FILE NO.	
			MODEL NAME	H-05A20LXX		X.x	±0.20		
			3RD ANGLE PROJ	HanElectricity Co.,LTD			X.xx	±0.15	
						ANGULAR	±3°		

X-ON Electronics

Largest Supplier of Electrical and Electronic Components

Click to view similar products for [FFC & FPC Connectors](#) category:

Click to view products by [HanElectricity](#) manufacturer:

Other Similar products are found below :

[00-6200-227-022-800](#) [006205250500825+](#) [006205280500825+](#) [FPH-1602G](#) [086222026001800](#) [52610-0675](#) [62674-201121DLF](#) [52746-1671-TR250](#) [10051922-1610EHLF](#) [10051922-2810EHLF](#) [686322124422](#) [XF3M-2915-1B-R100](#) [AYF353125A](#) [AYF530665TA](#) [AYF534065TA](#) [20FLH-RSM1-TB](#) [PCA-7F-25-HL-3-G](#) [207356-1](#) [52807-0430](#) [502250-8027](#) [FH28K-40S-0.5SH](#) [200528-0260](#) [FH28K-10S-0.5SH](#) [501951-1250](#) [X05B20U43T](#) [0.5K-DX-30PWB](#) [DS1020-08-10VBT12](#) [THD0515-34CL-GF](#) [X05A10L28G](#) [ECC2841061EU](#) [20539-030E-01](#) [1.0K-DHGX-16PWB](#) [1.0K-DHGX-30PWB](#) [1775333-6](#) [10054365-202110ELF](#) [10054365-242110ELF](#) [10054365-282110ELF](#) [10064555-392220HLF](#) [59453-041110EBHLF](#) [59453-091110EDHLF](#) [62674-241141ALF](#) [62684-432100ALF](#) [62684-451100AHLF](#) [62684-5721N0ALF](#) [HFW11R-1STE1MTLF](#) [HFW12R-1STE9LF](#) [HFW14R-1STE9MTLF](#) [HFW18S-2STE9LF](#) [HFW20R-1STAE1HLF](#) [HFW20R-1STE1MTLF](#)