

PCB参考图

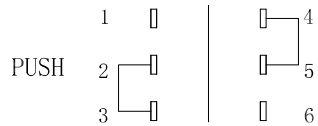

电路简示图

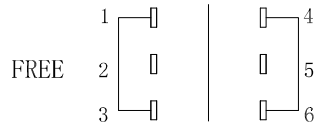
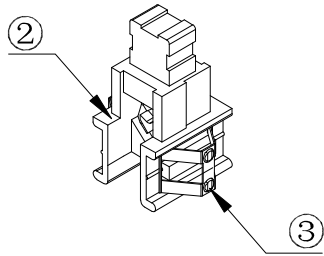
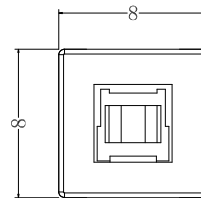
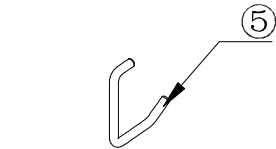
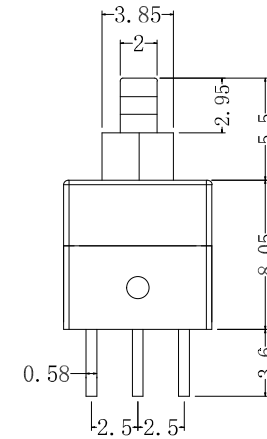
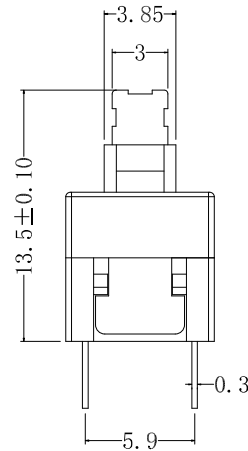
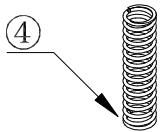

KFC8080-X

OPERATION:W:NO LOCK Z:LOCK

按力: 230 ±30gf

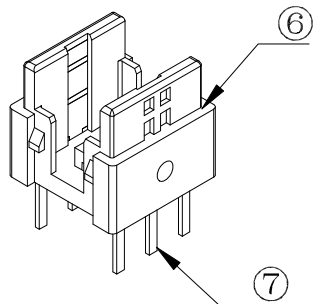

编号	组成部分	数量	材料名称及型号	备注
1	盖子	1	PC	白色
2	按键	1	POM	蓝色
3	簧片	2	磷铜	镀银
4	弹簧	1	碳素钢丝	本色
5	钩针	1	不锈钢丝	本色
6	底座	1	PA66	黑色
7	针脚	6	H65黄铜	镀银

DESIGNED		CHECKED		APPROVAL		DRAWING NUMBER		DATE		REV.		SCALE	
Mikey		Tom		Jerry		KFC8080-X		2015/5/3		A		3:1	
PART NAME		MODEL NAME		3RD ANGLE PROJ		KFC8080-X		KFC8080-X		UNLESS OTHERWISE SPECIFIED,TOLERANCE:		X. ±0.25 X.x ±0.20 X.xx ±0.15 ANGULAR ±3°	
HanElectricity Co.,LTD								FILE.NO.					

瀚源

X-ON Electronics

Largest Supplier of Electrical and Electronic Components

Click to view similar products for [Pushbutton Switches](#) category:

Click to view products by [HanElectricity](#) manufacturer:

Other Similar products are found below :

[8971K1133](#) [LW2L-M1C20M-A](#) [01-153.025](#) [M22-D-R-GB0/K11](#) [67021K512](#) [701PB580](#) [7199K101](#) [810K12910](#) [810KSV30B](#) [FLT 2U EE](#)
[01A](#) [MML21EA2ADK](#) [MML21KA3ABK](#) [MML23KW3AA01W](#) [8418K2](#) [8442K3](#) [8450K1](#) [860K11911T01A](#) [861901](#) [861K11911T01A07](#)
[861K13810T00A14](#) [861K13911](#) [8646AB6X718UL](#) [9533CD4+U574+U4922](#) [99-450.837](#) [99-453.837](#) [A2PMA1X03EC56](#) [A3A-7310](#) [A3A-](#)
[7340](#) [12037A2ULCSA](#) [1203A2UL](#) [ABGW410-R](#) [1211390004](#) [ABN400-R](#) [121382](#) [1213C3](#) [HE3B-M2](#) [1211500044](#) [121194](#) [1212MRA](#)
[1232A6NF](#) [121489](#) [1223A2ULCSA](#) [D5P-MT4](#) [13435AG](#) [13445AD29GX768](#) [AG23-L2](#) [AH165-2SGLG1TE3](#) [AH165-TGFY22](#) [AH165-](#)
[TGL5Y11E3](#) [AH165-TGLR11AA3](#)