

H
2.5

主要技术规格:

1. 额定值: 50mA DC12V
2. 接触电阻: 100mΩ
3. 操作力: 250±30gf
4. 行程: 0.20±0.1mm
5. 绝缘电阻: 100MΩ
6. 抗电强度: 250V 50HZ 1Min.
7. 寿命: 30,000 Cycles

材料:

- 本体: PPA (黑色)
- 按钮: PPA (黑色)
- 卡件: 黄铜 (镀银)
- 弹片: 不锈钢 (复银)
- 盖板: 铁 (镀铜锡)

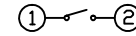
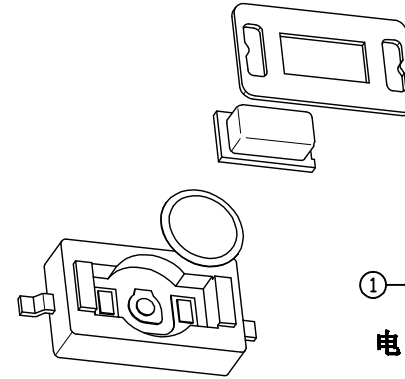
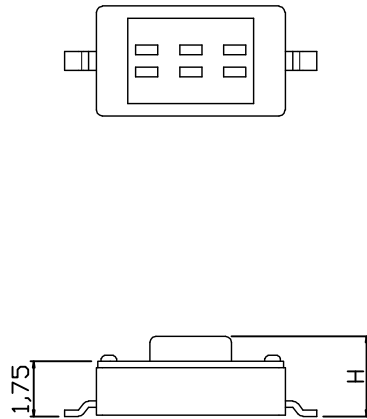
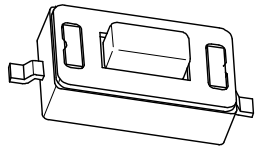

电路图

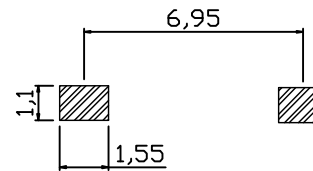
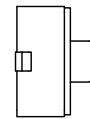
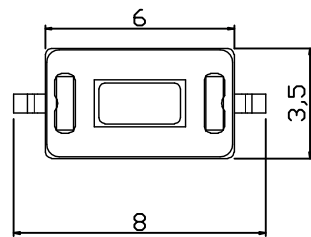

PCB. 焊接图

PAPT NO	TS1101A-X-X
Operating Force	160 : 160gf ; 260 : 260gf
Height	25 : 2.5mm

		new		2015/5/3	A	瀚源
ECN BO.		DESCRIPTION.		DATE.	REV.	
DESIGNED	CHECKED	APPROVAL	DRAWING NUMBER	SCALT: 1/2		SCALE: 3:1
Mikey	Tom	Jerry	PART NAME	TS1101A-X-X	UNLESS OTHERWISE SPECIFIED, TOLERANCE:	X. ±0.25
			MODEL NAME	TS1101A-X-X		X.x ±0.20
			3RD ANGLE PROJ	HanElectricity Co.,LTD		X.xx ±0.15
					ANGULAIR	±3
					FILE.NO.	

X-ON Electronics

Largest Supplier of Electrical and Electronic Components

Click to view similar products for [Tactile Switches](#) category:

Click to view products by [HanElectricity](#) manufacturer:

Other Similar products are found below :

[6407-250V-25273P](#) [ADTSA62NV](#) [B3F-3123](#) [1977177-8](#) [1977266-1](#) [ADTSA63NV](#) [ADTSM21NSVTR](#) [ADTSM25RVTR](#) [ADTSM32NVTR](#)
[ADTSMW64RV](#) [1977120-6](#) [FSMRA4JHA04](#) [GS4.70F300QP](#) [KSC241J SP DELTA LFS](#) [3FTL600RAS](#) [3FTL640RAS](#) [6407-250V-25343P](#)
[ADTSM31NVTR](#) [2-1977120-7](#) [TSJW-5.2-260-TR](#) [Y651050400P](#) [KMT011MNGJLHS](#) [70-201.0](#) [ADTSG648NV](#) [ADTSM62KSVTR](#)
[ADTSM648NV](#) [95C06E3RAT](#) [3ATH9Q](#) [FSMRA8JHA04](#) [HARS0073](#) [Y33R411N9FPLFT](#) [Y33R51139FPLFT](#) [Y31C01402FPLFS](#)
[PTS645SK50SMTR92](#) [ADTSM32NVB](#) [KMS233GPWTLFG](#) [Y78B64124FP](#) [Y31CJ244KFP LFS](#) [Y96D113G0FP LFS](#) [Y33A812C5FP LFT](#)
[Y56B2D120FP LFS](#) [Y31C5144KFP LFS](#) [PTS645 DVM83-BN125-2 LFS](#) [B3W 1000G](#) [KSC621G OL LFS](#) [B3F 1002C](#) [B3F 0047H](#) [B3W](#)
[1002C](#) [B3F 5001G](#) [B3W 1100C](#)