

HR913129A

Electrical Specification @25°C

RoHS Compliant (PB Free)

Isolation: 2250VDC 0.5mA 60sec (UTP Side to Chip Side)

OCL: 350uH Minimum @100KHz 100mV with 8mADC

Insertion Loss: -1.0dB Maximum @300KHz ~ 100MHz

Return Loss: -20dB Minimum @1MHz ~ 10MHz / -16dB Minimum @10MHz ~ 30MHz
-12dB Minimum @30MHz ~ 60MHz / -10dB Minimum @60MHz ~ 80MHz

Common Mode Rejection: -30dB Minimum @1MHz ~ 50MHz
-20dB Minimum @50MHz ~ 150MHz

Crosstalk: -40dB Minimum @1MHz ~ 30MHz / -35dB Minimum @30MHz ~ 60MHz
-30dB Minimum @60MHz ~ 100MHz

Schematics

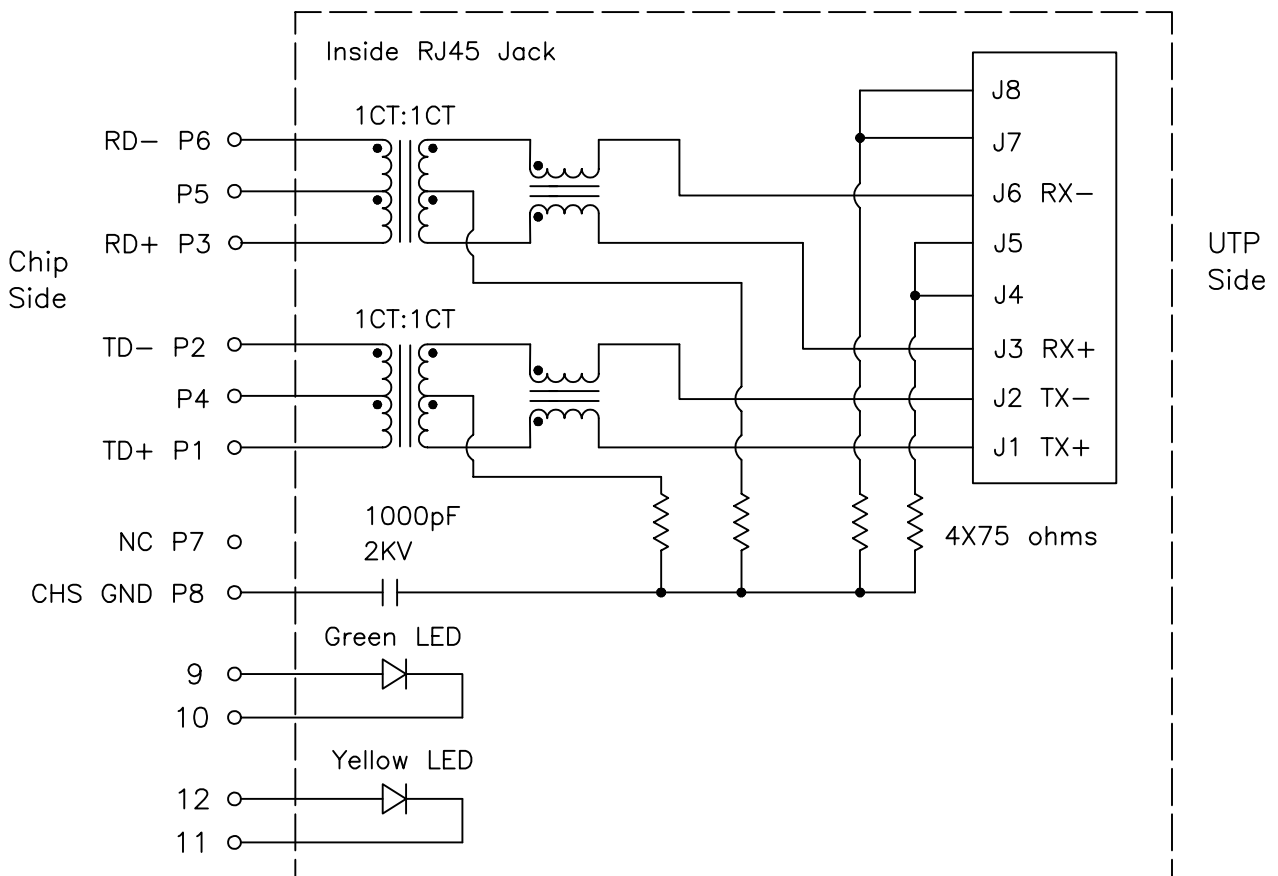

Notes: Connect CHS GND to PCB Ground

HR913129A

- RoHS Compliant (PB Free)
- Meets or Exceeds IEEE802.3 standards including 350uH Min OCL with 8mADC
- High performance for EMI suppression, Crosstalk, Return Loss and Consistent Electrical
- Minimum 2250VDC isolation per IEEE802.3 requirement
- Minimize PCB space and Simplify PCB Layout
- Less magnetic components to be placed on PCB, higher reliability and yields
- UL Recognized Component: File # E330599

Mechanical Dimensions:

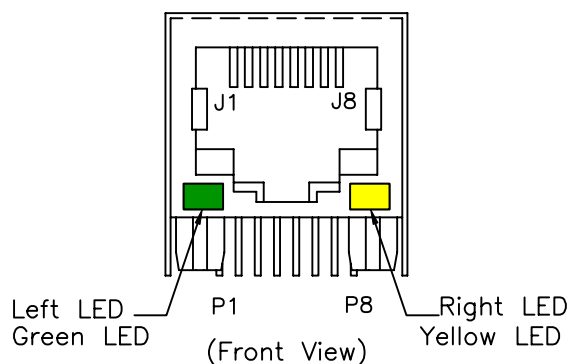
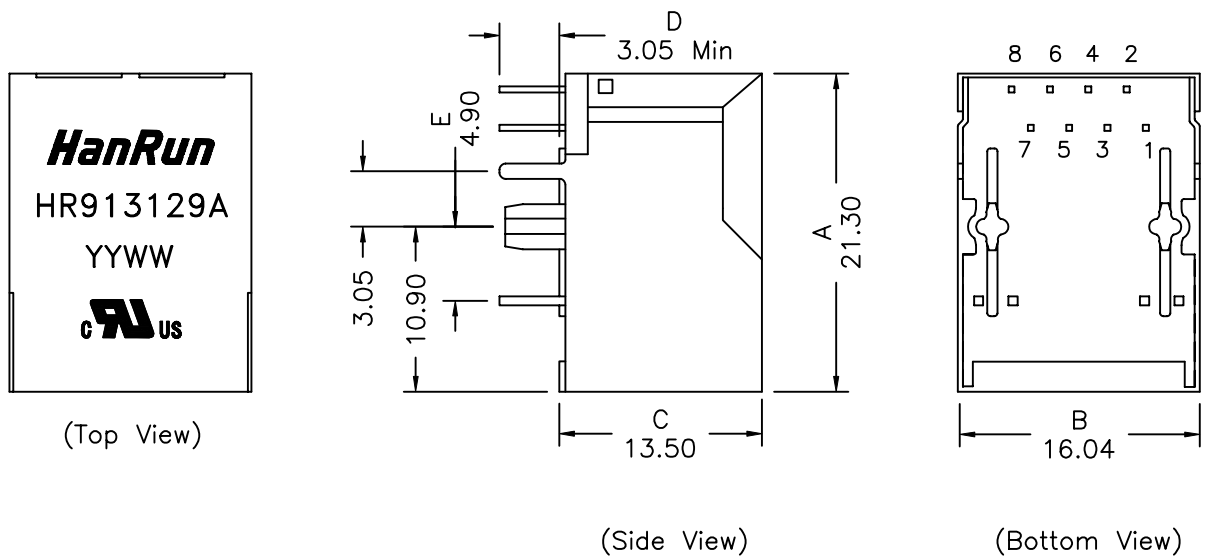

Standard LED	Wavelength	Forward V (Min/Max)	Forward A	Type
Green	568nm	1.8V/2.8V	20mA	squareness
Yellow	585nm	1.8V/2.8V	20mA	squareness

Dimensions in mm

Unless otherwise specified, Tolerance: .xx ±0.25

REV.: 00

HR913129A

PCB Layout:

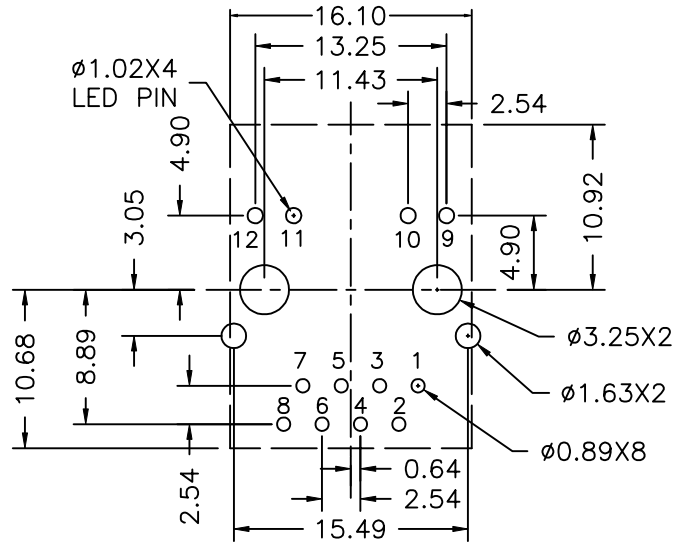

Recommended PCB layout (Component Side View)
All dimension tolerance are ± 0.08 unless otherwise specified

Suggested Panel Cutout:

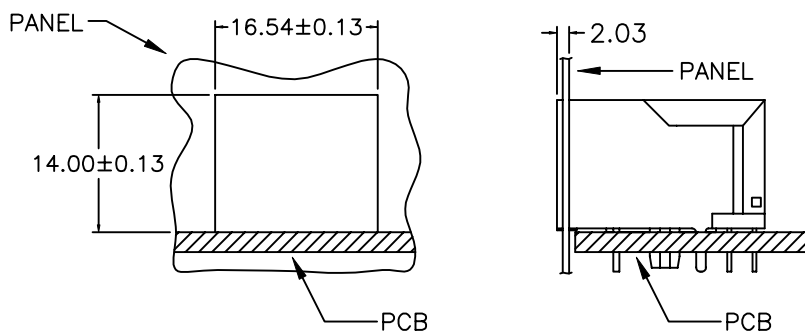

SUGGESTED PANEL OPENING

Dimensions in mm

Unless otherwise specified, Tolerance: $.xx \pm 0.25$

REV.: 00

HR913129A

Material Specification:

Housing: PA66 GF Black UL94V-0
Shield: 30u" Nickel over 0.20mm Thickness Brass
Insert: PA66 GF Black UL94V-0
Phosphor Bronze 0.35mm Thickness
Plating Area, 30u" gold over, 50u" nickel
Solder Area, 100u" tin over, 50u" nickel

Mechanical Performance:

Mating force: 5 lbs Maximum
Unmating force: 5 lbs Maximum
Plug to Jack Retention force: 20 lbs Minimum
Operating life: 750 Cycles Minimum

Operating and Storage Temperature:

Operating Temperature Range: 0°C ~ +85°C
Storage Temperature Range: -40°C ~ +85°C

X-ON Electronics

Largest Supplier of Electrical and Electronic Components

Click to view similar products for [Modular Connectors / Ethernet Connectors](#) category:

Click to view products by [HanRun](#) manufacturer:

Other Similar products are found below :

[8949-H88/06BLKA/SN](#) [74441-0010/BKN](#) [PHP-6P6C-5](#) [GAX-3-66](#) [GAX-8-62](#) [GDCX-PN-66](#) [GLX-A-44](#) [GLX-N-1010M-BLK](#) [GMX-SMT4-N-88](#) [GSGX-N-2-88](#) [GSGX-N-4-88](#) [GSX-NS2-88-3.05](#) [GSX-NS-88-3.68](#) [PT-108A-8C-UL](#) [PTS-J531-8CS-50UL](#) [1-1775629-2](#) [A-2014-0-4](#) [GWLX-S9-88-YG](#) [DC-1021-8-WH-6](#) [1300530003](#) [1324640-4](#) [RJ11FTVC2G](#) [RJ11FTVC2N](#) [RJFTVX2SA1G](#) [132764-001](#) [1413235](#) [MPS88RX-5000](#) [E5288-S000K3-L](#) [155302-001](#) [AX101050](#) [AX101063](#) [AX101065](#) [AX101072](#) [AX101307](#) [AX101314](#) [AX101315](#) [AX101318](#) [AX102271](#) [AX102288](#) [AX102651](#) [AX102660](#) [HXJ5EOR](#) [J0012D21NL](#) [J0026D01ENL](#) [PC4D0018P](#) [8949-B88/6](#) [2-6609208-5](#) [937-SP-3088-2PC-A192](#) [303066VFL](#) [303068V](#)