

序号	品名	材质
①	1.50-K型立式WTB胶芯带扣	PART UL94V-0 米白色
②	1.50-K型立式WTB端子	黄铜/表面镀锡
③	1.50-K型立式WTB胶盖	LCP E473i 本色/黑色

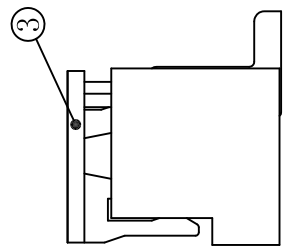

WITH COVER

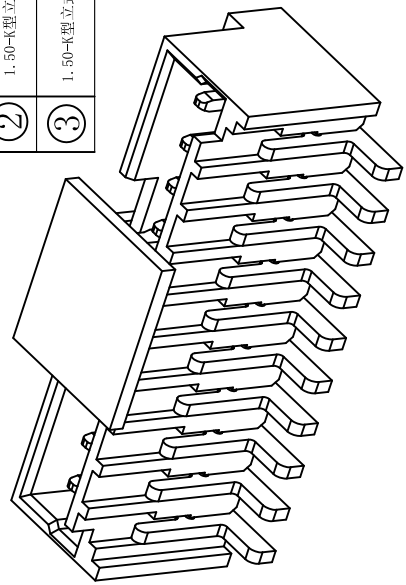
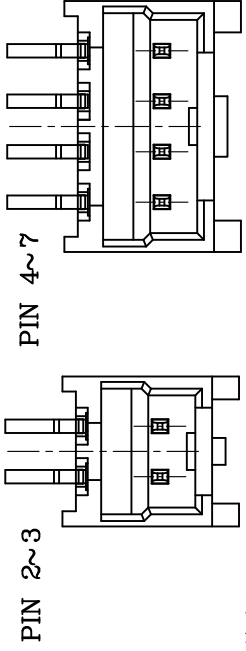
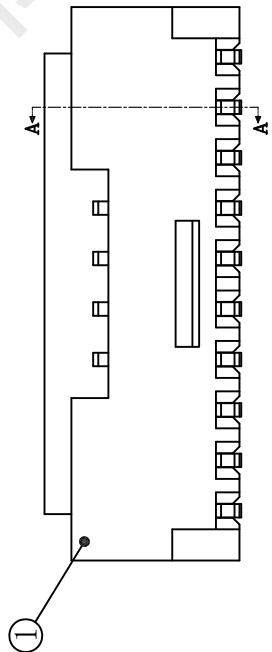
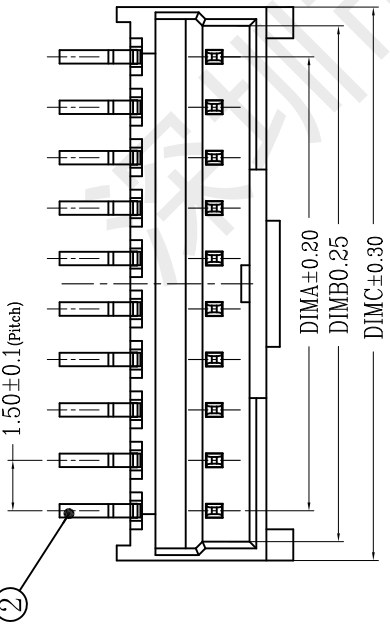
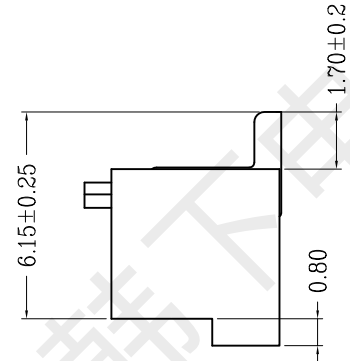

适用线路板

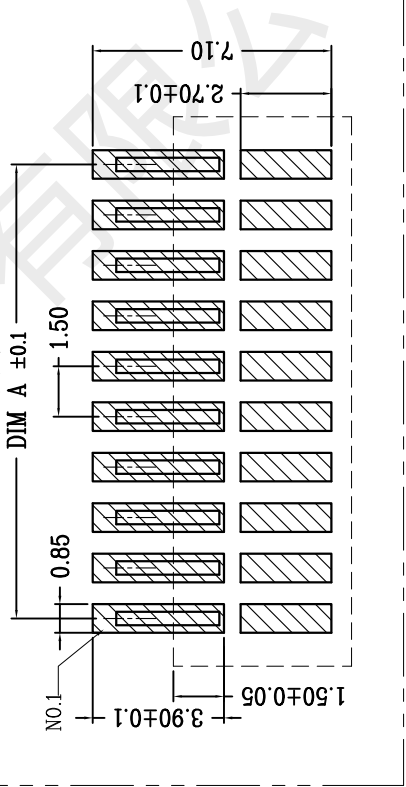

CKT	DIM A	DIM B	DIM C
2	1.50	3.35	4.46
3	3.00	4.85	5.96
4	4.50	6.35	7.46
5	6.00	7.85	8.96
6	7.50	9.35	10.46
7	9.00	10.85	11.96
8	10.50	12.35	13.46
9	12.00	13.85	14.96
10	13.50	15.35	16.46
11	15.00	16.85	17.96
12	16.50	18.35	19.46
13	18.00	19.85	20.96
14	19.50	21.35	22.46
15	21.00	22.85	23.96

技术指标:

1. 塑件表面应光洁、无毛边、无明显收缩、缺陷、裂纹等现象。
2. 温度范围: -25° C ~ 85° C.
3. 额定电压: 350V AC, DC.
4. 接触电阻: ≤ 0.02Ω.
5. 绝缘电阻: ≥ 1000MΩ.
6. 额定电流: 3A AC, DC.

**韩下 HANXIA** 深圳市韩下电子有限公司

制图 (DR) 黄彬  
审核 (CHKD) 张伟  
批准 (APPD) 罗小春  
张数 (SHEET) 1 OF 1  
尺寸 (SIZE) A4  
REV A

品名 (TITLE) 针座  
料号 (DWG.NO) HX 1.5mm-2P LTDK  
单位 (UNITS) mm  
比例 (SCALE) 1:1

一般公差 (TOLERANCE)  
X ±0.10  
Y ±0.20  
Z ±0.30  
ANGLES ±1°



深圳市韩下电子有限公司

Shenzhen Hanxia Electronic Co., Ltd  
Tel: 0755-33819206 Fax: 0755-27597491

## 承 认 书

### SPECIFICATION FOR APPROVAL

客 户 Customer:

\_\_\_\_\_

产品名称 Project:

针座

\_\_\_\_\_

规格型号 Part No:

HX 1.5mm-2P LTK

\_\_\_\_\_

#### 贵公司承认印 Approval signatures

料 号/Part No.	签 章/Signatures

日期 Date:

拟制/Drawn	黄彬	
审核/Check	张伟	
批准/Approved	罗小春	



## 1、SCOPE: (适用范围)

1.1 This specification covers production and inspection of Connector.

本规范内容适用于本公司普通系列型条形连接器（针座）产品的生产与检验。

## 2、USE CONDITION: (使用条件)

2.1 Ambient temperature Range:-25℃~+85℃

环境温度：-25℃~+85℃

2.2 Applicable PC board thickness:1.2~1.6mm

适用 PC 板厚度：1.2~1.6 mm

## 3、Appearance and Dimension: (外观及尺寸)

3.1 Appearance:Product surface without defect、dirt、crack、and mechanical damang, Contact without rust,plating not oxided and not peeled.

产品表面不应有对制品有害的缺陷、污垢、裂痕及机械损伤；接触件无锈蚀、镀层氧化、脱落等现象。

3.2 Dimension:According to drawings

外形尺寸：依照附图

3.3 Exchangable:Exchangable with same specification products.

互换性：相同规格应能互换

## 4、Material:

材 料 （以图纸为准）

P/N 零件名称	Type 类 型	Material 材 料	Finish 表面处理	Expiain 说 明
Terminal 端子	Contact 插 簧	Phosphor bronze 锡青磷铜 厚 0.15mm	Tin Plating:3~4 μ m 镀锡：3~4 μ m	RoHS Comp liant
Housing 孔 座	Plastic 塑 壳	Nylon66 UL94V-0	Color:White 颜色：白色	
OpeningWafer 开口针座	Contact 插 针	Phosphor bronze 锡青磷铜 厚 0.30mm	Tin Plating:3~4 μ m 镀锡：3~4 μ m	
	Plastic 塑 壳	Nylon46 UL94V-0	Color: Beige 颜色：米色	
Lips Wafer 闭口针座	Contact 插 针	Phosphor bronze 锡青磷铜 厚 0.30mm	Gold Plating:3~4 μ " m 镀金：3~4 μ " m	
	Plastic 塑 壳	PBT UL94V-0	Color: White 颜色：白色	
Tiepian Wafer 卧贴针座 立贴针座	Contact 插 针	Phosphor bronze 锡青磷铜 厚 0.30mm	Tin Plating:3~4 μ m 镀锡：3~4 μ m	
	Solder tabs 焊护耳	Phosphor bronze 锡青磷铜 厚 0.25mm	Tin Plating:3~4 μ m 镀锡：3~4 μ m	
	Plastic 塑 壳	Nylon46 UL94V-0	Color: Beige 颜色：米色	



## 5、Electrical Performance:

电气性能

NO. 序号	Item 项目	Requirement 技术要求
5.1	Voltage Rated 额定电压	350V AC DC
5.2	Current Rated 额定电流	3A AC DC
5.3	Contact Resistance 接触电阻	$\leq 20 \text{ m}\Omega$
5.4	Insulation Resistance 绝缘电阻	$\geq 1000 \text{ M}\Omega$
5.5	Dielectric Strength 耐压	$\geq 800 \text{ V AC/minute}$

## 6、Mechanical Performance:

机械性能

NO. 序号	Item 项目	Requirement 技术要求
6.1	Male contact Retention force PIN 针固定力	$\geq 10 \text{ N}$ per pin
6.2	Female contact Retention force 端子固定力	$\geq 10 \text{ N}$ per pin
6.3	Plug-in force 插入力	$\leq 3 \text{ N}$ per pin
6.4	Plug-out force 拔出力	$\geq 0.5 \text{ N}$ per pin

## 7、Endurance Characteristics:

环境性能

NO. 序号	Item 项目	Requirement 技术要求
7.1	Soldering rest 可焊性	Time: $2.5 \pm 0.5 \text{ S}$ 时间: $2.5 \pm 0.5 \text{ S}$ Temperature: $260 \pm 5^\circ \text{C}$ 温度: $260 \pm 5^\circ \text{C}$ Area of Soldering: $\geq 95\%$ 焊锡面积: $\geq 95\%$
7.2	Resistance to soldering Heat 耐焊接热	Time: $5 \pm 1 \text{ S}$ 时间: $5 \pm 1 \text{ S}$ Temperature: $260 \pm 5^\circ \text{C}$ 温度: $260 \pm 5^\circ \text{C}$ Appearance: NO Damage 外观: 无损坏

7.3	<b>Heat test</b> 耐热性	Time:96h 时间: 96 小时 Temperature:+85±3℃ 温度: +85±3℃ Appearance:NO Damage 外观: 无损坏 Contact resistance: ≤20 mΩ 接触电阻: ≤20 mΩ
7.4	<b>Cold test</b> 耐冷性	Time:48h 时间: 48 小时 Temperature:-25±3℃ 温度: -25±3℃ Appearance:NO Damage 外观: 无损坏 Contact resistance:≤20 mΩ 接触电阻: ≤20 mΩ
7.5	<b>Temperature Cycling</b> 温度循环	Low temperature:-25±3℃ 低温: -25±3℃ High temperature:85±3℃ 高温: 85±3℃ For 5 cycles.test after keeping in Normal Condition for 30 min. 5 次循环后, 放置在正常环境中 30 分钟, 在进行测试 Appearance: NO Damage 外观: 无损坏 Contact resistance: ≤20 mΩ 接触电阻: ≤20mΩ
7.6	<b>Invariab lenes humidity</b> 恒定湿热	Temperature:60±2℃ 温度: 60±2℃ Relative humidity:90%-96% RH 相对湿度: 90%-96% RH Tim:96h 时间: 96 小时 Appearance:NO Damage 外观: 无损坏 Contact resistance: ≤20 mΩ 接触电阻: ≤20 mΩ Insulation Resistance: ≥100MΩ 绝缘电阻: ≥100 MΩ
7.7	<b>Salt Spray</b> 盐雾试验	Salt concentration: 5±1% 浓度: 5±1% Temperature:35±2℃ 温度: 35±2℃ Tim:16±2h 时间: 16±2 小时 After salt is removed by running wafer and A drop is removed ,it is measured. 把试验样品从试验箱顶悬挂下来, 采用浓度 (5±1) %的氯化钠溶液, 连续雾化 16 小时, 试验后用流动的蒸馏水 轻轻洗去表面沉积物, 在常温常驻湿条件下恢复 1-2 小时, 外观无损伤 Appearance:NO Damage 外观: 无损坏 Contact resistance: ≤20 mΩ 接触电阻: ≤20 mΩ

## X-ON Electronics

Largest Supplier of Electrical and Electronic Components

*Click to view similar products for [Headers & Wire Housings](#) category:*

*Click to view products by [hanxia](#) manufacturer:*

Other Similar products are found below :

[0015917161](#) [0022155065](#) [57102-F02-18ULF](#) [58102-G61-06LF](#) [582553-1](#) [01.001.5753.1](#) [0050291907](#) [02.125.8002.8](#) [609-3404](#) [61062-3](#)  
[CSU011177004](#) [622-0430](#) [622-3653LF](#) [63453-116](#) [636-1030](#) [636-1427](#) [636-3427](#) [636-4007](#) [641938-9](#) [65495-038](#) [65692-001LF](#) [65781-018](#)  
[65781-047](#) [65817-010LF](#) [65817-015LF](#) [67095-007LF](#) [67601157](#) [68631-112](#) [68645-018](#) [699319-000](#) [70.362.1628.0](#) [70-4210](#) [70-4226B](#) [70-](#)  
[4853B](#) [71.350.2428.0](#) [733-134](#) [733-162](#) [760-3052](#) [MHR-64-VUAL](#) [80.063.4001.1](#) [800-90-001-10-001000](#) [801-43-002-10-013000](#)  
[801-43-006-10-002000](#) [803-43-024-10-001000](#) [803-93-012-10-001000](#) [8-1437020-4](#) [819-22-004-30-001101](#) [820-22-006-30-001101](#)  
[820-22-008-30-001101](#) [821-22-002-10-001101](#)