

A		B		C		D		E		F	
N-0.5±0.03 (SQ)		2.00±0.15 (PITCH)		0		变更摘要 (Change The Content)		日期 (Date)		品名 (Name)	
0		新产品发行 (New Product Launch)		2020/09/09 (NO.)		LCP UL94V-0		2.00 F型卧式2代WTB板芯 2.00 Pitch R/A Wire To Board Housing (H=5, 2)		材质 (Material)	
①		②		③		LCP UL94V-0 本色 Natural		2.00 F型卧式2代WTB端子 2.00 Pitch R/A Wire To Board Terminal (H=5, 2)		铜合金/表面镀锡 Copper Alloy/ Tin Plating	
③		②		①		铜合金/表面镀锡 Copper Alloy/ Tin Plating		2.00 F型卧式WTB焊片 2.00 Pitch R/A Wire To Board Fitting Nail (H=5, 6)		铜合金/表面镀锡 Copper Alloy/ Tin Plating	

**技术指标 (Technical Index):**  
 1. 塑件表面应光洁、无毛边、无明显收缩、缺陷、裂纹等现象。  
 (The surface of the plastic parts should be smooth, no rough edges, no obvious shrinkage, defects, cracks and other phenomena)  
 2. 温度范围 (Temperature range): -40° C~+85° C.  
 3. 额定电压 (Rated voltage): 250V, AC.  
 4. 接触电阻 (Contact resistance):  
 ≤55mΩ (Initial) per contact, ≤25mΩ Change allowed.  
 5. 绝缘电阻 (Insulation resistance): ≥1000M Ω.

CKT	DIM A	DIM B	DIM C
2	2.00	4.90	8.00
3	4.00	6.90	10.00
4	6.00	8.90	12.00
5	8.00	10.90	14.00
6	10.00	12.90	16.00
7	12.00	14.90	18.00
8	14.00	16.90	20.00
9	16.00	18.90	22.00
10	18.00	20.90	24.00
11	20.00	22.90	26.00
12	22.00	24.90	28.00
13	24.00	26.90	30.00
14	26.00	28.90	32.00
15	28.00	30.90	34.00
16	30.00	32.90	36.00
17	32.00	34.90	38.00
18	34.00	36.90	40.00
19	36.00	38.90	42.00
20	38.00	40.90	44.00

**深圳市韩下电子有限公司**  
 HANKIA

**针座**

制图 (DRA) 黄彬  
 校对 (CHKD) 张伟  
 审核 (APPD) 罗小春  
 张数 (SHEET) 1 OF 1  
 版次 (REV) A

料号 (DWG.NO) HX 2.0-2P WTDK  
 单位 (UNITS) mm  
 比例 (SCALE) 1:1

品名 (TITLE) 针座  
 料号 (DWG.NO) HX 2.0-2P WTDK  
 比例 (SCALE) 1:1  
 单位 (UNITS) mm

RoHS  
 一般公差 (TOLERANCE)  
 X ±0.10  
 X ±0.20  
 X ±0.30  
 ANGLES ±1°

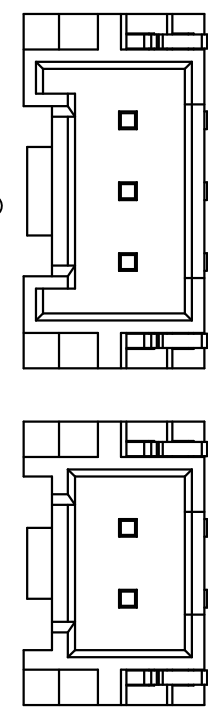
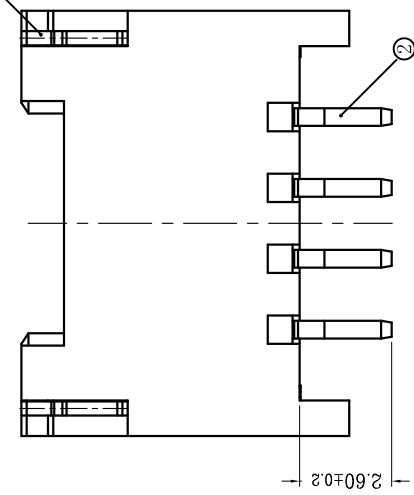
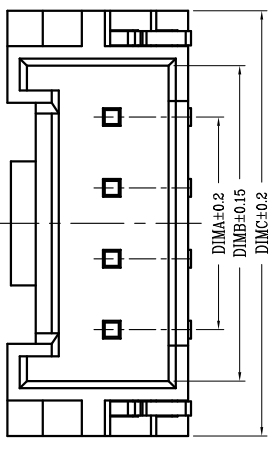
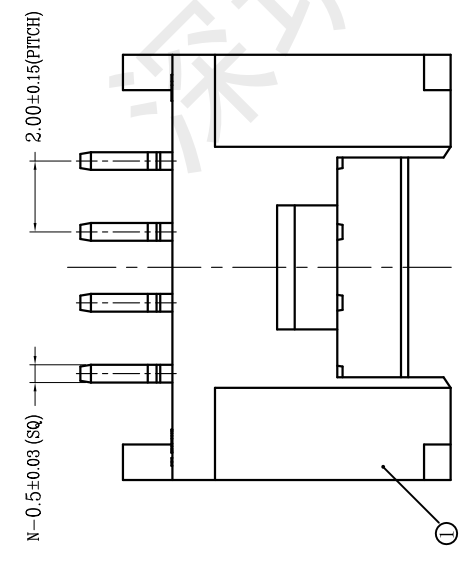
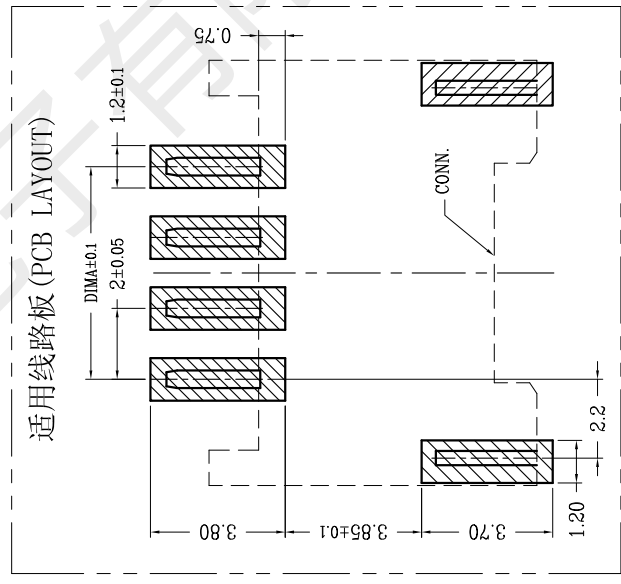
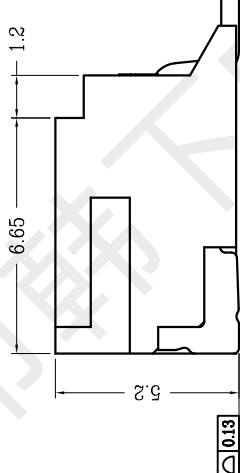
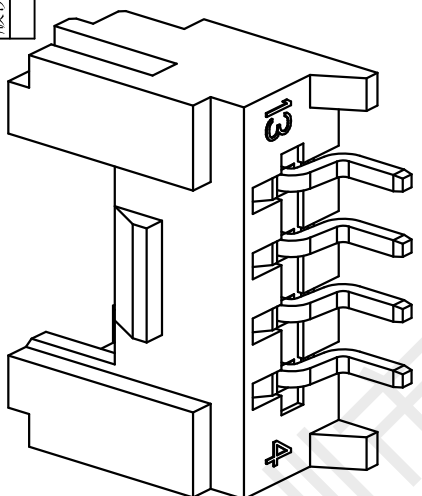



深圳市韩下电子有限公司

Shenzhen Hanxia Electronic Co., Ltd  
Tel: 0755-33819206 Fax: 0755-27597491

## 承 认 书

### SPECIFICATION FOR APPROVAL

客 户 Customer:

\_\_\_\_\_

产品名称 Project:

针座

规格型号 Part No:

HX 2.0-2P WTDK

#### 贵公司承认印 Approval signatures

料 号/Part No.	签 章/Signatures

日期 Date:

拟制/Drawn	黄彬	
审核/Check	张伟	
批准/Approved	罗小春	

## 1、SCOPE: (适用范围)

1.1 This specification covers production and inspection of Connector.

本规范内容适用于本公司普通系列型条形连接器（针座）产品的生产与检验。

## 2、USE CONDITION: (使用条件)

2.1 Ambient temperature Range:  $-40^{\circ}\text{C} \sim +85^{\circ}\text{C}$

环境温度:  $-40^{\circ}\text{C} \sim +85^{\circ}\text{C}$

2.2 Applicable Wire Sizes: AWG#28~#22

适用线规: AWG#28~#22

2.3 Applicable PC board thickness: 1.2~1.6mm

适用PC板厚度: 1.2~1.6 mm

## 3、Appearance and Dimension: (外观及尺寸)

3.1 Appearance: Product surface without defect, dirt, crack, and mechanical damage, Contact without rust, plating not oxidized and not peeled.

产品表面不应有对制品有害的缺陷、污垢、裂痕及机械损伤；接触件无锈蚀、镀层氧化、脱落等现象。

3.2 Dimension: According to drawings

外形尺寸: 依照附图

3.3 Exchangable: Exchangable with same specification products.

互换性: 相同规格应能互换

## 4、Material:

材料 (以图纸为准)

P/N 零件名称	Type 类型	Material 材料	Finish 表面处理	Explain 说明
Terminal 端子	Contact 插簧	Phosphor bronze 锡青磷铜 厚 0.15mm	Tin Plating: 3~4 $\mu\text{m}$ 镀锡: 3~4 $\mu\text{m}$	RoHS Compliant
Housing 孔座	Plastic 塑壳	Nylon66 UL94V-0	Color: White 颜色: 白色	
Opening Wafer 开口针座	Contact 插针	Phosphor bronze 锡青磷铜 厚 0.30mm	Tin Plating: 3~4 $\mu\text{m}$ 镀锡: 3~4 $\mu\text{m}$	
	Plastic 塑壳	Nylon46 UL94V-0	Color: Beige 颜色: 米色	
Lips Wafer 闭口针座	Contact 插针	Phosphor bronze 锡青磷铜 厚 0.30mm	Gold Plating: 3~4 $\mu\text{m}$ 镀金: 3~4 $\mu\text{m}$	
	Plastic 塑壳	PBT UL94V-0	Color: White 颜色: 白色	
Tiepian Wafer 卧贴针座 立贴针座	Contact 插针	Phosphor bronze 锡青磷铜 厚 0.30mm	Tin Plating: 3~4 $\mu\text{m}$ 镀锡: 3~4 $\mu\text{m}$	
	Solder tabs 焊护耳	Phosphor bronze 锡青磷铜 厚 0.25mm	Tin Plating: 3~4 $\mu\text{m}$ 镀锡: 3~4 $\mu\text{m}$	
	Plastic 塑壳	Nylon46 UL94V-0	Color: Beige 颜色: 米色	

## 5、Electrical Performance:

电气性能

N0. 序号	Ltem 项目	Requirement 技术要求
5.1	Voltage Rated 额定电压	250V AC DC
5.2	Current Rated 额定电流	2A AC DC
5.3	Contact Resistance 接触电阻	$\leq 0.025 \Omega$
5.4	Insulation Resistance 绝缘电阻	$\geq 1000 M\Omega$
5.5	Dielectric Strength 耐压	$\geq 800V$ AC/minute

## 6、Mechanical Performance:

机械性能

N0. 序号	Ltem 项目	Requirement 技术要求
6.1	Male contact Retention force PIN 针固定力	$\geq 15N$ per pin
6.2	Female contact Retention force 端子固定力	$\geq 15N$ per pin
6.3	Plug-in force 插入力	$\leq 3N$ per pin
6.4	Plug-out force 拔出力	$\geq 0.5N$ per pin

## 7、Endurance Characteristics:

环境性能

N0. 序号	Ltem 项目	Requirement 技术要求
7.1	Soldering rest 可焊性	Time: $2.5 \pm 0.5S$ 时间: $2.5 \pm 0.5S$  Temperature: $260 \pm 5^\circ C$ 温度: $260 \pm 5^\circ C$  Area of Soldering: $\geq 95\%$ 焊锡面积: $\geq 95\%$

7.2	Resistance to soldering Heat 耐焊接热	<p>Time: 5 ± 1S 时间: 5 ± 1S</p> <p>Temperature: 260 ± 5°C 温度: 260 ± 5°C</p> <p>Appearance: NO Damage 外观: 无损坏</p>
7.3	Heat test 耐热性	<p>Time: 96h 时间: 96 小时</p> <p>Temperature: +85 ± 3°C 温度: +85 ± 3°C</p> <p>Appearance: NO Damage 外观: 无损坏</p> <p>Contact resistance: ≤ 20 mΩ 接触电阻: ≤ 20 mΩ</p>
7.4	Cold test 耐冷性	<p>Time: 48h 时间: 48 小时</p> <p>Temperature: -25 ± 3°C 温度: -25 ± 3°C</p> <p>Appearance: NO Damage 外观: 无损坏</p> <p>Contact resistance: ≤ 20 mΩ 接触电阻: ≤ 20 mΩ</p>
7.5	Temperature Cycling 温度循环	<p>Low temperature: -25 ± 3°C 低温: -25 ± 3°C</p> <p>High temperature: 85 ± 3°C 高温: 85 ± 3°C</p> <p>For 5 cycles. test after keeping in Normal Condition for 30 min. 5 次循环后, 放置在正常环境中 30 分钟, 在进行测试</p> <p>Appearance: NO Damage 外观: 无损坏</p> <p>Contact resistance: ≤ 20 mΩ 接触电阻: ≤ 20 mΩ</p>

7.6	Invariablenes humidity 恒定湿热	<p>Temperature: <math>60 \pm 2^{\circ}\text{C}</math> 温度: <math>60 \pm 2^{\circ}\text{C}</math></p> <p>Relative humidity: 90%-96% RH 相对湿度: 90%-96% RH</p> <p>Tim: 96h 时间: 96 小时 Appearance: NO Damage 外观: 无损坏</p> <p>Contact resistance: <math>\leq 20 \text{ m}\Omega</math> 接触电阻: <math>\leq 20 \text{ m}\Omega</math></p> <p>Insulation Resistance: <math>\geq 100 \text{ M}\Omega</math> 绝缘电阻: <math>\geq 100 \text{ M}\Omega</math></p>
7.7	Salt Spray 盐雾试验	<p>Salt concentration: <math>5 \pm 1\%</math> 浓度: <math>5 \pm 1\%</math></p> <p>Temperature: <math>35 \pm 2^{\circ}\text{C}</math> 温度: <math>35 \pm 2^{\circ}\text{C}</math></p> <p>Tim: <math>16 \pm 2\text{h}</math> 时间: <math>16 \pm 2</math> 小时</p> <p>After salt is removed by running wafer and A drop is removed ,it is measured.</p> <p>把试验样品从试验箱顶悬挂下来, 采用浓度(<math>5 \pm 1</math>) %的氯化钠溶液, 连续雾化 16 小时, 试验后用流动的蒸馏水轻轻洗去表面沉积物, 在常温常驻湿条件下恢复 1-2 小时, 外观无损伤</p> <p>Appearance: NO Damage 外观: 无损坏</p> <p>Contact resistance: <math>\leq 20 \text{ m}\Omega</math> 接触电阻: <math>\leq 20 \text{ m}\Omega</math></p>



## 8、 Packaging Transportation Storage

包装、运输、贮存

### 8.1 Packaging

包装

- (1) **The packing of plastic inner is the plastic bag,the packing of inner terminal is panel mounting attach material packing, marked with product name, specification model, quantity, date in produced.**

塑件内包装为塑料袋， 端子内包装为盘装带料包装， 装（贴）入合格证， 注明产品名称、规格型号、数量生产日期

- (2) **Exterior package is carton, facing the packing list, the packing list marked with product name, specificcation model, quantity, date of dispatch.**

外包装为纸箱，贴装箱单、装箱单上注明产品名称、规格型号、数量、出货日期

- (3) **The product in the box must not rock.**

产品在箱内不晃动

### 8.2 Transportation

运输

**Allow for any way transportation, can't get wet and mechanical in jury.**

允许用任何方式运输，勿淋湿及机械性损伤

### 8.3 Storage

贮存

**The connector of packing finished should be in the ambient temperature between-10℃ to+40℃, Relative humidity≤80%. To store in storehouse does not have acidic, alkaline air and other corrosive gas in the ambient air.**

包装完毕的连接器应在环境温度为-10℃~+40℃，相对湿度≤80%，周围空气中没有酸性，碱性及其它腐蚀性气体的库房中贮存

## X-ON Electronics

Largest Supplier of Electrical and Electronic Components

*Click to view similar products for [Headers & Wire Housings](#) category:*

*Click to view products by [hanxia](#) manufacturer:*

Other Similar products are found below :

[0015917161](#) [0022155065](#) [57102-F02-18ULF](#) [58102-G61-06LF](#) [582553-1](#) [01.001.5753.1](#) [0050291907](#) [02.125.8002.8](#) [609-3404](#) [61062-3](#)  
[CSU011177004](#) [622-0430](#) [622-3653LF](#) [63453-116](#) [636-1030](#) [636-1427](#) [636-3427](#) [636-4007](#) [641938-9](#) [65495-038](#) [65692-001LF](#) [65781-018](#)  
[65781-047](#) [65817-010LF](#) [65817-015LF](#) [67095-007LF](#) [67601157](#) [68631-112](#) [699319-000](#) [70.362.1628.0](#) [70-4210](#) [70-4226B](#) [70-4853B](#) [707-](#)  
[5028](#) [71.350.2428.0](#) [733-134](#) [733-162](#) [760-3052](#) [MHR-64-VUAL](#) [80.063.4001.1](#) [800-90-001-10-001000](#) [801-43-002-10-013000](#)  
[801-43-006-10-002000](#) [803-43-024-10-001000](#) [803-93-012-10-001000](#) [8-1437020-4](#) [819-22-004-30-001101](#) [820-22-006-30-001101](#)  
[820-22-008-30-001101](#) [821-22-002-10-001101](#)