

HD30N06 / HU30N06

60V N-Channel MOSFET

$$BV_{DSS} = 60 \text{ V}$$

$$R_{DS(on)} = 32 \text{ m}\Omega$$

$$I_D = 30 \text{ A}$$

TO-252 TO-251

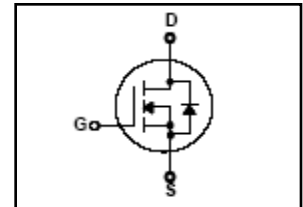
HD30N06 HU30N06
 1.Gate 2. Drain 3. Source

FEATURES

- Originative New Design
- Superior Avalanche Rugged Technology
- Robust Gate Oxide Technology
- Very Low Intrinsic Capacitances
- Excellent Switching Characteristics
- Unrivalled Gate Charge : 40 nC (Typ.)
- Extended Safe Operating Area
- Lower $R_{DS(ON)}$: 0.032 Ω (Typ.) @ $V_{GS}=10\text{V}$
- 100% Avalanche Tested

Absolute Maximum Ratings $T_C=25^\circ\text{C}$ unless otherwise specified

Symbol	Parameter	Value	Units
V_{DSS}	Drain-Source Voltage	60	V
I_D	Drain Current – Continuous ($T_C = 25^\circ\text{C}$)	30	A
	Drain Current – Continuous ($T_C = 100^\circ\text{C}$)	20	A
I_{DM}	Drain Current – Pulsed (Note 1)	30	A
V_{GS}	Gate-Source Voltage	± 20	V
E_{AS}	Single Pulsed Avalanche Energy (Note 2)	25	mJ
I_{AR}	Avalanche Current (Note 1)	50	A
E_{AR}	Repetitive Avalanche Energy (Note 1)	25	mJ
dv/dt	Peak Diode Recovery dv/dt (Note 3)	7.0	V/ns
P_D	Power Dissipation ($T_A = 25^\circ\text{C}$)*	3.75	W
	Power Dissipation ($T_C = 25^\circ\text{C}$)	23	W
	- Derate above 25°C	0.8	W/ $^\circ\text{C}$
T_J, T_{STG}	Operating and Storage Temperature Range	-55 to +150	$^\circ\text{C}$
T_L	Maximum lead temperature for soldering purposes, 1/8" from case for 5 seconds	300	$^\circ\text{C}$

Thermal Resistance Characteristics

Symbol	Parameter	Typ.	Max.	Units
$R_{\theta JC}$	Junction-to-Case	--	1.0	$^\circ\text{C}/\text{W}$
$R_{\theta JA}$	Junction-to-Ambient*	--	40	
$R_{\theta JA}$	Junction-to-Ambient	--	62.5	

* When mounted on the minimum pad size recommended (PCB Mount)

Electrical Characteristics $T_C=25\text{ }^\circ\text{C}$ unless otherwise specified

Symbol	Parameter	Test Conditions	Min	Typ	Max	Units
--------	-----------	-----------------	-----	-----	-----	-------

On Characteristics

V_{GS}	Gate Threshold Voltage	$V_{DS} = V_{GS}, I_D = 250\ \mu\text{A}$	1.0	2.3	3.0	V
$R_{DS(ON)}$	Static Drain-Source On-Resistance	$V_{GS} = 10\ \text{V}, I_D = 12\ \text{A}$	--	0.032	0.040	Ω

Off Characteristics

BV_{DSS}	Drain-Source Breakdown Voltage	$V_{GS} = 0\ \text{V}, I_D = 250\ \mu\text{A}$	60	--	70	V
$\Delta BV_{DSS} / \Delta T_J$	Breakdown Voltage Temperature Coefficient	$I_D = 250\ \mu\text{A}$, Referenced to $25\text{ }^\circ\text{C}$	--	0.06	--	$\text{V}/^\circ\text{C}$
I_{DSS}	Zero Gate Voltage Drain Current	$V_{DS} = 60\ \text{V}, V_{GS} = 0\ \text{V}$	--	--	1	μA
		$V_{DS} = 48\ \text{V}, T_C = 150\text{ }^\circ\text{C}$	--	--	10	μA
I_{GSSF}	Gate-Body Leakage Current, Forward	$V_{GS} = 20\ \text{V}, V_{DS} = 0\ \text{V}$	--	--	100	nA
I_{GSSR}	Gate-Body Leakage Current, Reverse	$V_{GS} = -20\ \text{V}, V_{DS} = 0\ \text{V}$	--	--	-100	nA

Dynamic Characteristics

C_{iss}	Input Capacitance	$V_{DS} = 30\ \text{V}, V_{GS} = 0\ \text{V}, f = 1.0\ \text{MHz}$	--	778		pF
C_{oss}	Output Capacitance		--	60		pF
C_{rss}	Reverse Transfer Capacitance		--	41		pF

Switching Characteristics

$t_{d(on)}$	Turn-On Time	$V_{DS} = 30\ \text{V}, I_D = 30\ \text{A}, R_G = 25\ \Omega$ (Note 4,5)	--	4.2		ns
t_r	Turn-On Rise Time		--	3.4	220	ns
$t_{d(off)}$	Turn-Off Delay Time		--	16	130	ns
t_f	Turn-Off Fall Time		--	2	140	ns
Q_g	Total Gate Charge	$V_{DS} = 30\ \text{V}, I_D = 30\ \text{A}, V_{GS} = 10\ \text{V}$ (Note 4,5)	--	13.5		nC
Q_{gs}	Gate-Source Charge		--	3.2	--	nC
Q_{gd}	Gate-Drain Charge		--	6.2	--	nC

Source-Drain Diode Maximum Ratings and Characteristics

I_S	Continuous Source-Drain Diode Forward Current	--	--	30	A	
I_{SM}	Pulsed Source-Drain Diode Forward Current	--	--	60		
V_{SD}	Source-Drain Diode Forward Voltage	$I_S = 30\ \text{A}, V_{GS} = 0\ \text{V}$	--	--	0.99	V
t_{rr}	Reverse Recovery Time	$I_S = 30\ \text{A}, V_{GS} = 0\ \text{V}, di_f/dt = 100\ \text{A}/\mu\text{s}$ (Note 4)	--	27	--	ns
Q_{rr}	Reverse Recovery Charge		--	30	--	μC

Notes ;

1. Repetitive Rating : Pulse width limited by maximum junction temperature
2. $L=230\ \mu\text{H}, I_{AS}=15\ \text{A}, V_{DD}=25\ \text{V}, R_G=25\ \Omega$, Starting $T_J=25\text{ }^\circ\text{C}$
3. $I_{SD} \leq 50\ \text{A}, di/dt \leq 300\ \text{A}/\mu\text{s}, V_{DD} \leq BV_{DSS}$, Starting $T_J=25\text{ }^\circ\text{C}$
4. Pulse Test : Pulse Width $\leq 300\ \mu\text{s}$, Duty Cycle $\leq 2\%$
5. Essentially Independent of Operating Temperature

TYPICAL ELECTRICAL AND THERMAL CHARACTERISTICS (Curves)

Figure1. On-Region Characteristics

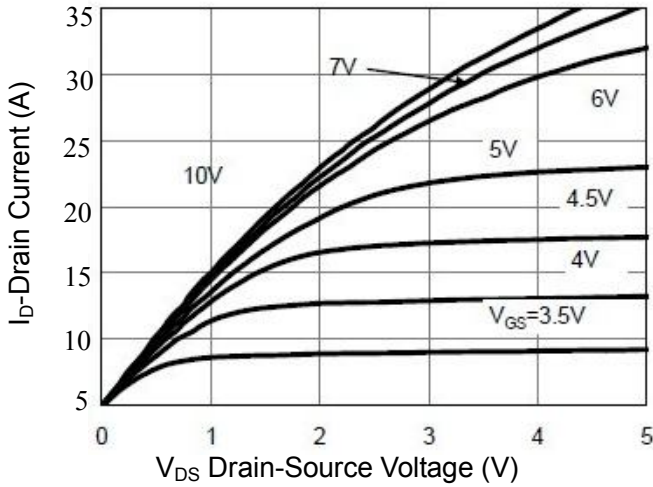

Figure 2: Transfer Characteristics

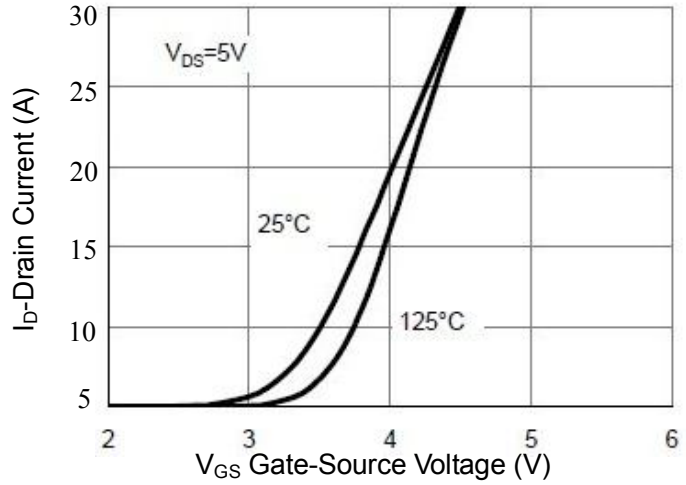

Figure3. ID vs Junction Temperature

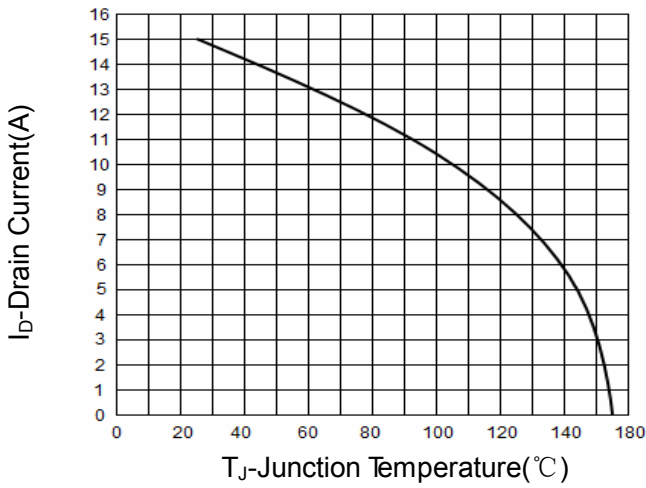

Figure4. On-Resistance vs. Junction Temperature

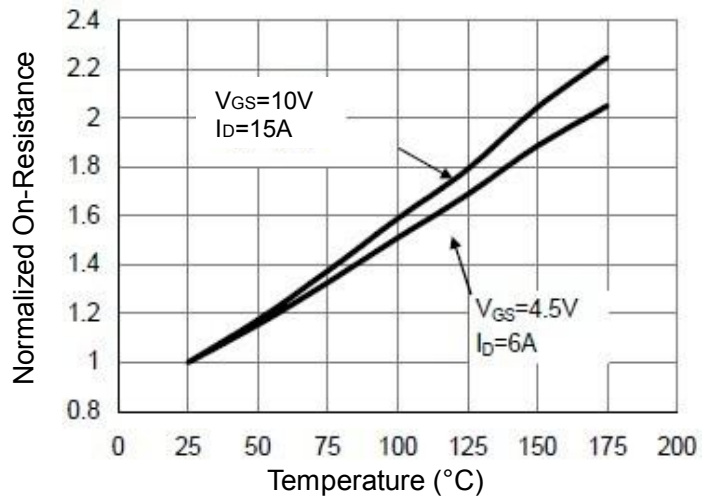

Figure5. On-Resistance vs. Gate-Source Voltage

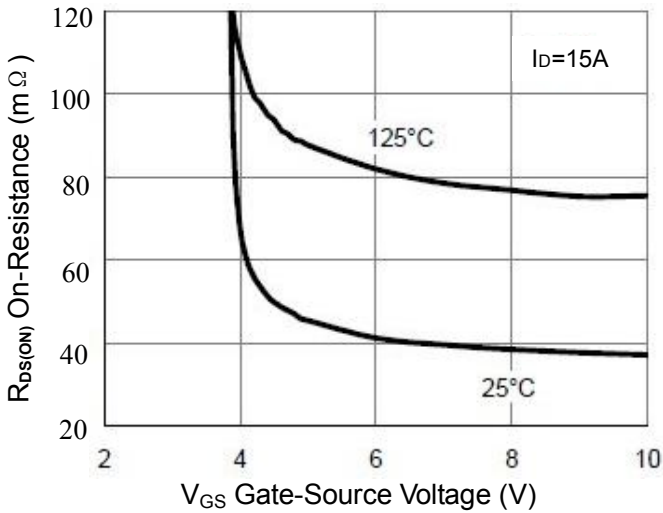

Figure6. Body-Diode Characteristics

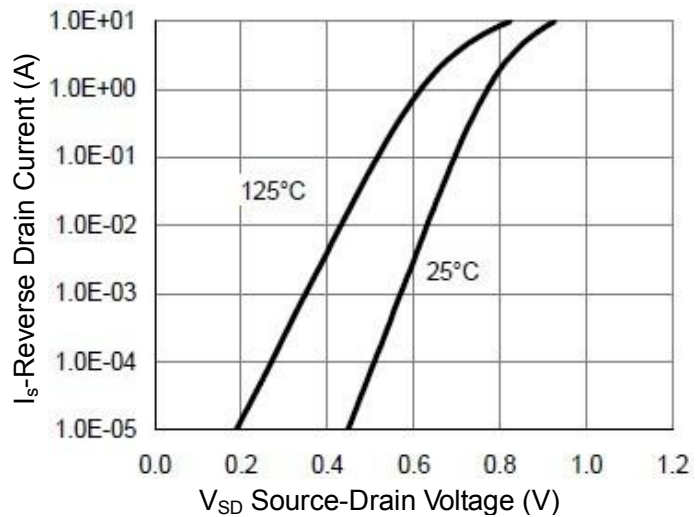

Figure7. Gate-Charge Characteristics

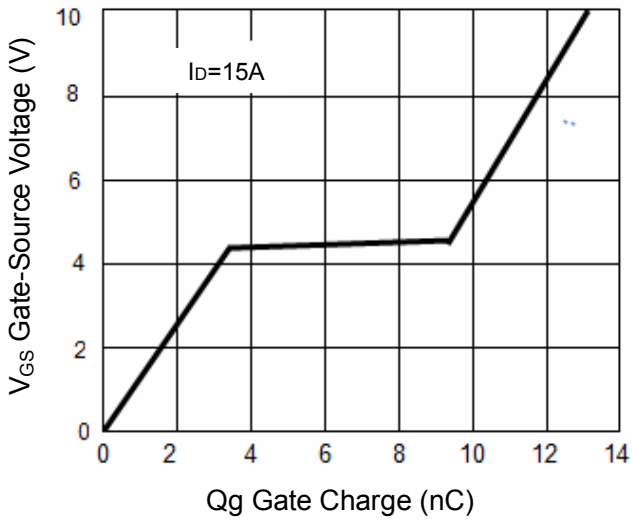

Figure 8. Capacitance Characteristics

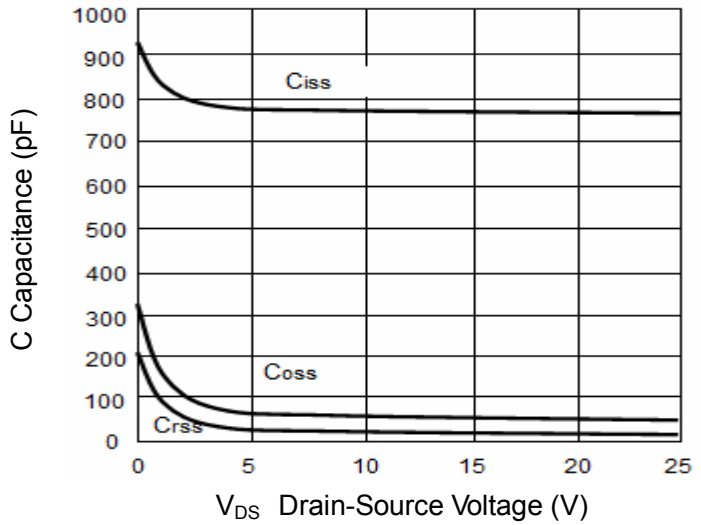

Figure 9. Maximum Forward Biased Safe Operating Area

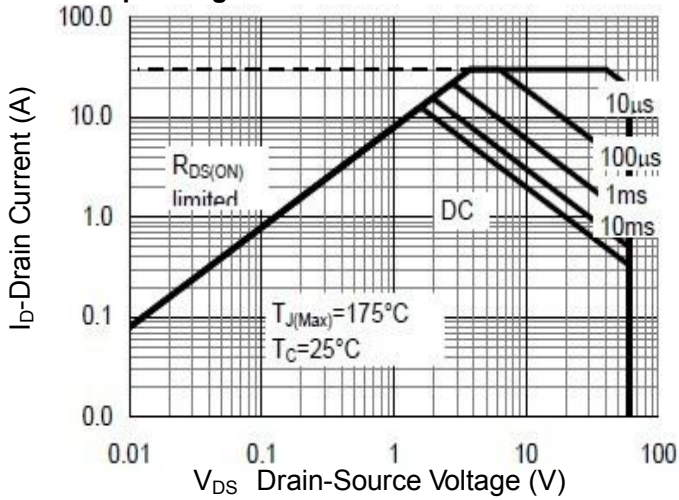

Figure10. Single Pulse Power Rating Junction-to-Cas

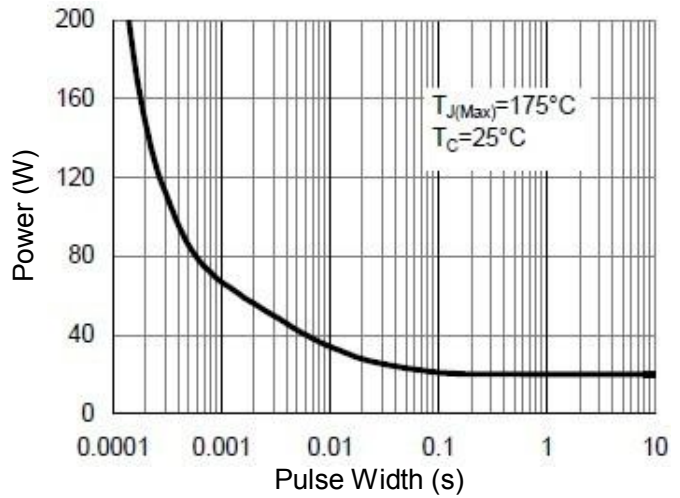

Figure11. Normalized Maximum Transient Thermal Impedance

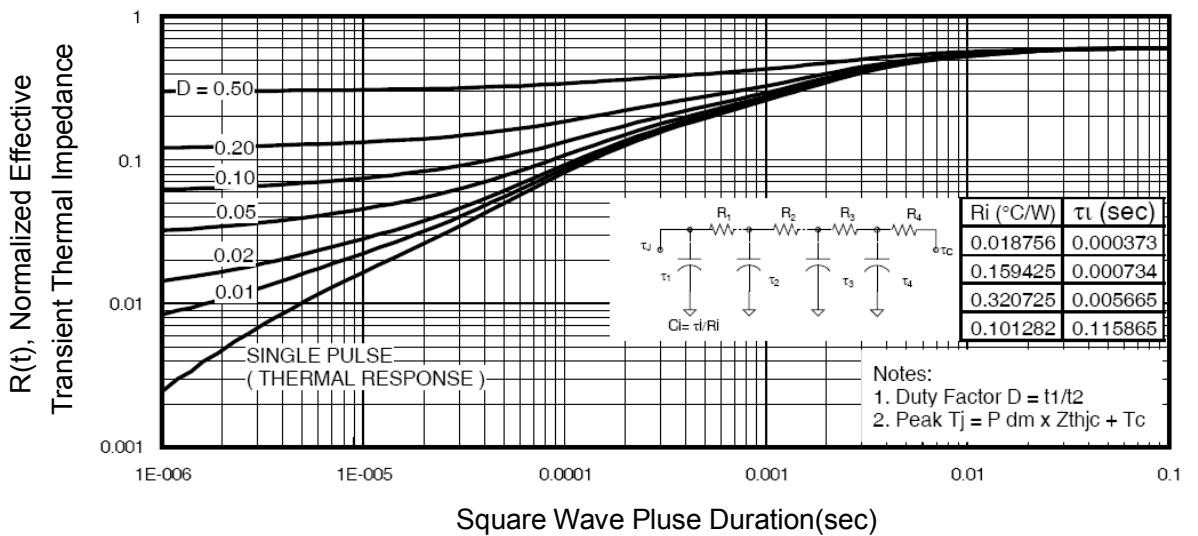

Fig 12. Gate Charge Test Circuit & Waveform

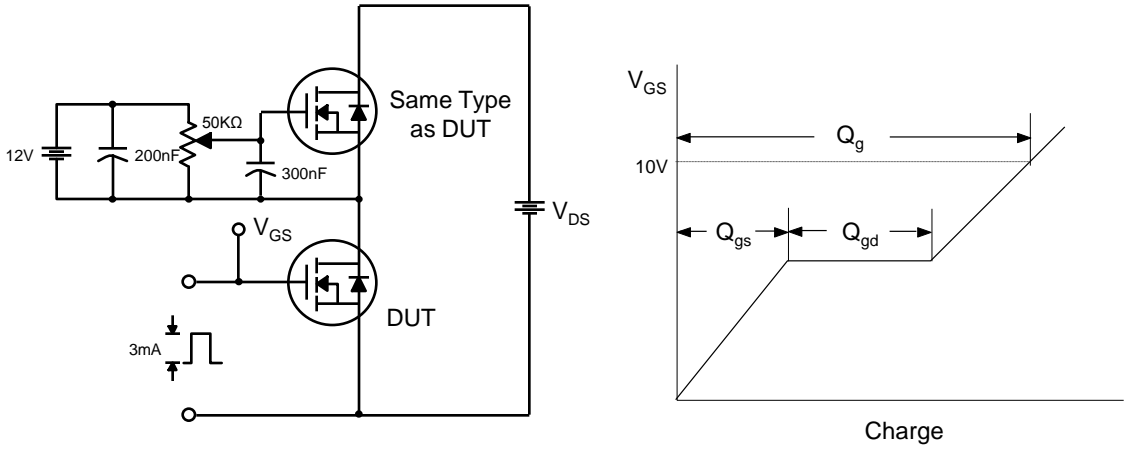

Fig 13. Resistive Switching Test Circuit & Waveforms

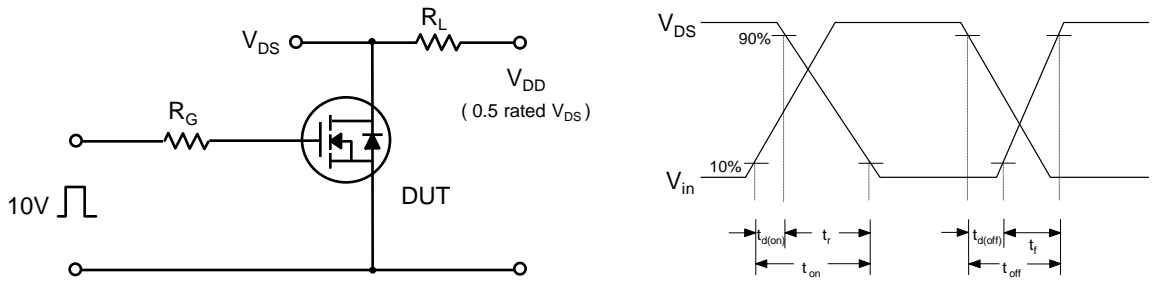

Fig 14. Unclamped Inductive Switching Test Circuit & Waveforms

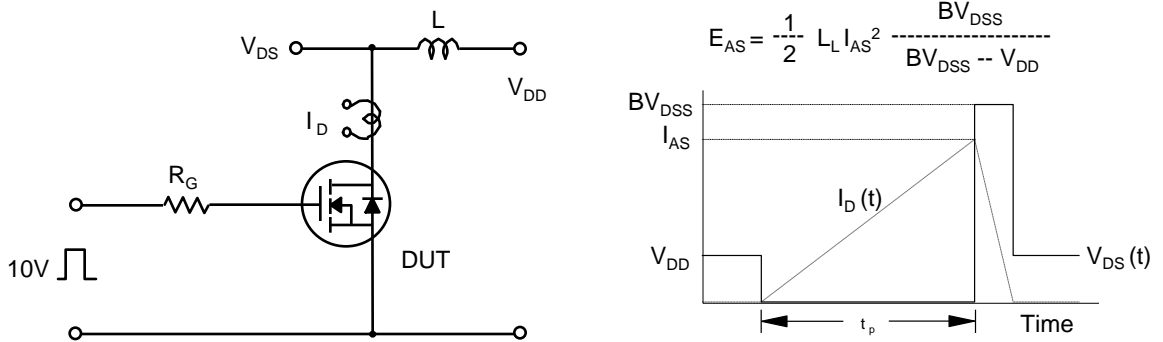
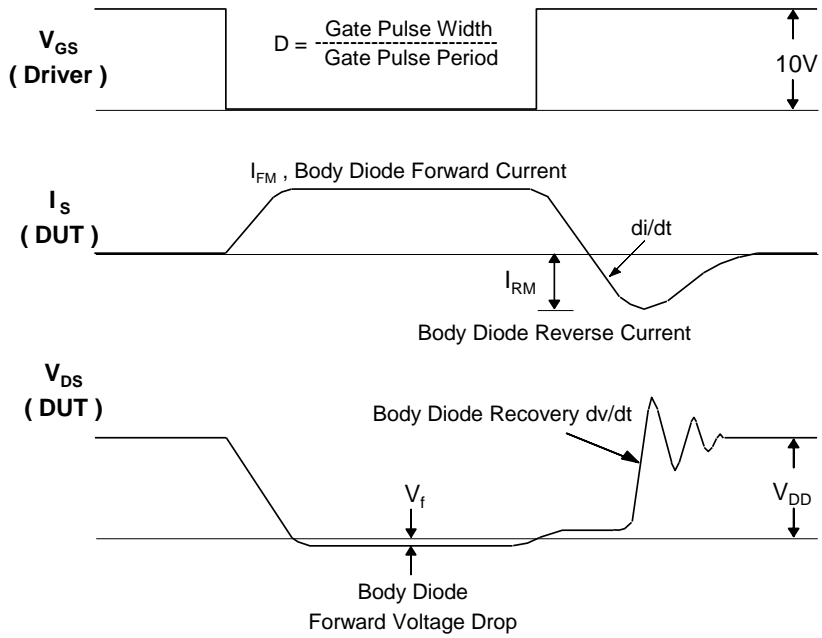
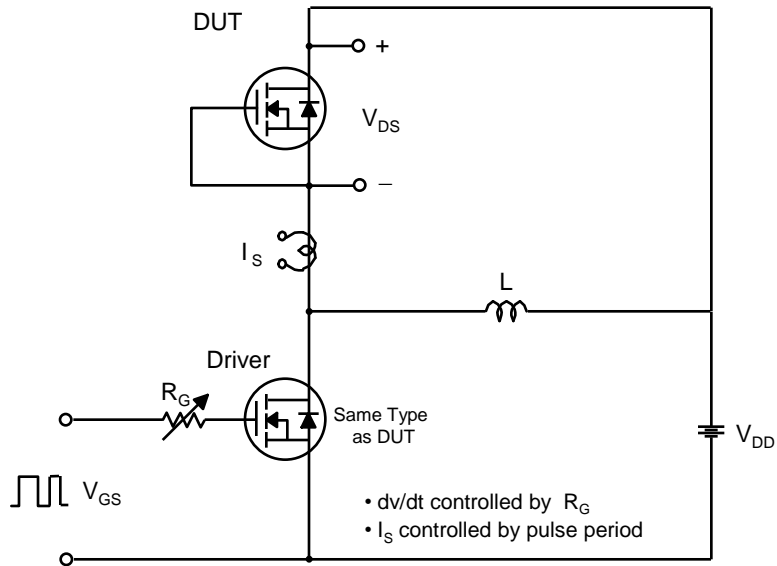
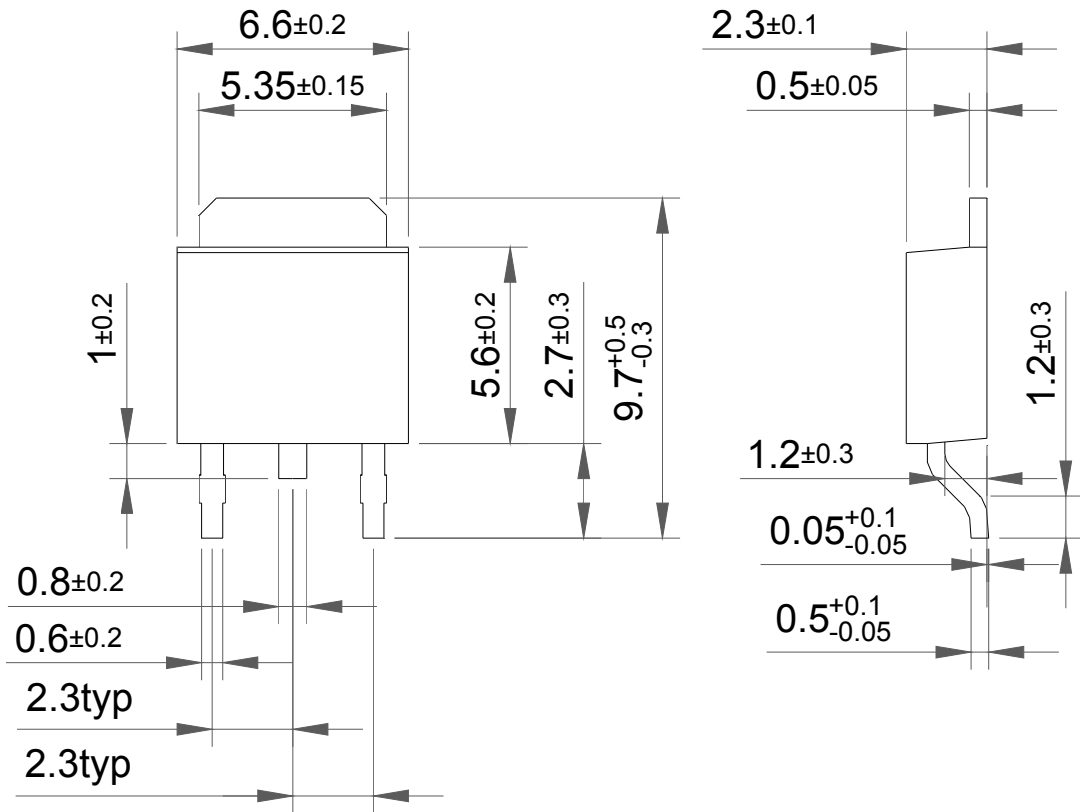

Fig 15. Peak Diode Recovery dv/dt Test Circuit & Waveforms



Package Dimension

TO-252



Package Dimension

TO-251

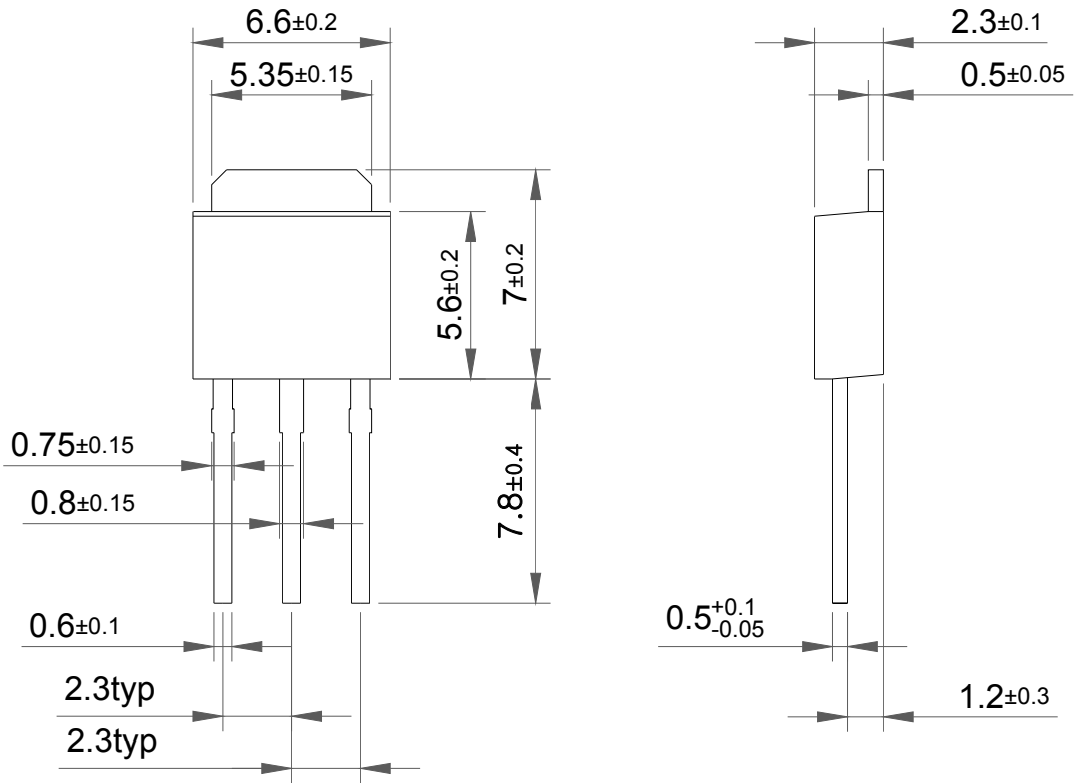

HD30N06_HU30N06

X-ON Electronics

Largest Supplier of Electrical and Electronic Components

Click to view similar products for [MOSFET](#) category:

Click to view products by [Haolin](#) manufacturer:

Other Similar products are found below :

[IRFD120](#) [IRFY240C](#) [JANTX2N5237](#) [BUK455-60A/B](#) [MIC4420CM-TR](#) [VN1206L](#) [NDP4060](#) [SI4482DY](#) [IPS70R2K0CEAKMA1](#)
[SQD23N06-31L-GE3](#) [TK16J60W,S1VQ\(O](#) [2SK2614\(TE16L1,Q\)](#) [DMN1017UCP3-7](#) [EFC2J004NUZTDG](#) [DMN1053UCP4-7](#) [SQJ469EP-](#)
[T1-GE3](#) [NTE2384](#) [DMC2700UDMQ-7](#) [DMN2080UCB4-7](#) [DMN61D9UWQ-13](#) [US6M2GTR](#) [DMN31D5UDJ-7](#) [DMP22D4UFO-7B](#)
[DMN1006UCA6-7](#) [DMN16M9UCA6-7](#) [STF5N65M6](#) [IRF40H233XTMA1](#) [STU5N65M6](#) [DMN6022SSD-13](#) [DMN13M9UCA6-7](#)
[DMTH10H4M6SPS-13](#) [DMN2990UFB-7B](#) [IPB80P04P405ATMA2](#) [2N7002W-G](#) [MCAC30N06Y-TP](#) [MCQ7328-TP](#) [NTMC083NP10M5L](#)
[NVMFS2D3P04M8LT1G](#) [BXP7N65D](#) [BXP4N65F](#) [AOL1454G](#) [WMJ80N60C4](#) [BXP2N20L](#) [BXP2N65D](#) [BXT1150N10J](#) [BXT1700P06M](#)
[TSM60NB380CP](#) [ROG](#) [RQ7L055BGTCR](#) [DMNH15H110SK3-13](#) [SLF10N65ABV2](#)