

PRELIMINARY SPECIFICATIONS



Customer Part No.: _____ HELE. Part No: **X3S026000B71HZ-NHPZ**

Application For: _____ Products: **CRYSTAL**

Accepted Model: _____ Type & Freq.: **HSX321S / 26.000MHz**

Sample Order No: _____ Date: **2008/09/23**

Approved By :

加高電子股份有限公司

加高電子股份有限公司

HARMONY ELECTRONICS CORP.

HARMONY ELECTRONICS (THAILAND) CO., LTD.

HARMONY ELECTRONICS (SHENZHEN) CORP., LTD.

TAIPEI OFFICE:

公司:(114)
台北市內湖區堤頂大道 2 段 409 號 2 樓
2F., NO.409, SEC.2, TIDING BLVD.,
NEIHU DISTRICT, TAIPEI CITY 114,
TAIWAN (R.O.C.)
TEL:886-2-26588883
FAX:886-2-26588683

TAIWAN FACTORY:

工廠:(831)
高雄縣大寮鄉大發工業區華東路 39 號
NO. 39, HWA DONG RD., TA FA IND.
DIST., TA LIAO KAOHSIUNG HSIEN 831,
TAIWAN, R.O.C.
TEL: (07)787-1555-6
FAX: (07)787-1557

THAILAND FACTORY:

66MOO 5, KAONGU-BEOKPRAI RD.,
T.BEOKPRAI, A. BANPONG,
RAJCHABUREE PROVINCE 70110,
THAILAND
TEL: (032)221994-6, 200740-1
FAX: (032)200742

SHENZHEN FACTORY:

深圳市福永鎮塘尾村塘橋路聚源工業區
QIAO TANG RD., TANGWEI VILLAGE
FU YONG TOWN SHENZHEN CITY
CHINA
TEL: 0755-7309272 / 7309262
FAX: 0755-7309755

Title HSX321S QUARTZ CRYSTAL SPECIFICATION				Remark THAILAND FACTORY TAIWAN FACTORY		
Date	Confirm	Check	Prepare	Spec. No.	Rev.	Page
2008/09/23	F. S. TSAI	C. L. WANG	U. F. CHEN	X3S026000B71HZ-NHPZ	0	1

HARMONY ELECTRONICS CORP.

HSX321S SPECIFICATION

INDEX

ITEM	PAGE
1. QUARTZ CRYSTAL UNIT SPECIFICATION	3
2. MARKING & DIMENSIONS	4
3. INSIDE STRUCTURE	5
4. EMBOSS CARRIER TAPE&REEL	6
a. DIMENSIONS OF CARRIER TAPE	6
b. DIMENSIONS OF REEL	6-7
c. STORAGE CONDITION	7
d. STANDARD PACKING QUANTITY	7
e. MATERIAL OF TAPE	7
f. LABEL CONTENTS	7
g. TAPING DIMENSION	8
h. JOINT OF TAPE	8
i. RELEASE STRENGHT OF COVER TAPE	8
5. MECHANICAL PERFORMANOE	9
6. ENVIRONMENTAL PERFORMANOE	9-10
7. SUPPLRMENT	10-11
8. FLOW CHARD	12
9. Environmental Workload Chemical Substance Components List .	13
10. TEST DATA	

Title HSX321S				Remark THAILAND FACTORY		
QUARTZ CRYSTAL SPECIFICATION				TAIWAN FACTORY		
Date	Confirm	Check	Prepare	Spec. No.	Rev.	Page
2008/09/23	F. S. TSAI	C. L. WANG	U. F. CHEN	X3S026000B71HZ-NHPZ	0	2

1. QUARTZ CRYSTAL UNIT SPECIFICATION

- | | |
|--------------------------------|---|
| 1. Frequency: | 26.000000MHz |
| 2. Holder type : | HSX321S |
| 3. Frequency tolerance: | +/- 10 ppm at 25deg.C +/-3deg.C |
| 4. Equivalent resistance: | 40 ohms Max. / SERIES |
| 5. Storage temperature range: | -45 deg.C To +95 deg.C |
| 6. Operable temperature range: | -20 deg.C To +85 deg.C |
| 7. Temperature drift: | +/-10 ppm -20 deg.C To +85deg.C |
| 8. Loading capacitance (CL) : | 10.9 pF +/-0.2 pF |
| 9. Drive level: | 100 uW +/- 10 uW |
| 10. Shunt Capacitance: | 2.0 pF Max |
| 11. Insulation resistance : | More than 500M ohms at DC 100V |
| 12. Mode of oscillation: | Fundamental |
| 13. Circuit: | Measured in HP/E5100A,S&A 250B |
| 14. Shocking : | Dropping from 50 cm height 3 times on firm wood |
| Variation : | Frequency less than +/-5 ppm
Resistance less than +/- 15 % or 2ohms max. |
| 15. Aging: | Less than +/- 1 ppm/Year |
| 16. Holder | HSX321S Seam type |
| 17. Dimensions and marking | Refer to page.4 |
| 18. Emboss carrier tape & reel | Refer to page.6 and page.7 |
| 19. Note: | TS: 12.5 ppm/pF Typ (@CL=10.9pF) |

Title HSX321S QUARTZ CRYSTAL SPECIFICATION				Remark THAILAND FACTORY TAIWAN FACTORY		
Date	Confirm	Check	Prepare	Spec. No.	Rev.	Page
2008/09/23	F. S. TSAI	C. L. WANG	U. F. CHEN	X3S026000B71HZ-NHPZ	0	3

2. HSX321S MARKING & DIMENSIONS

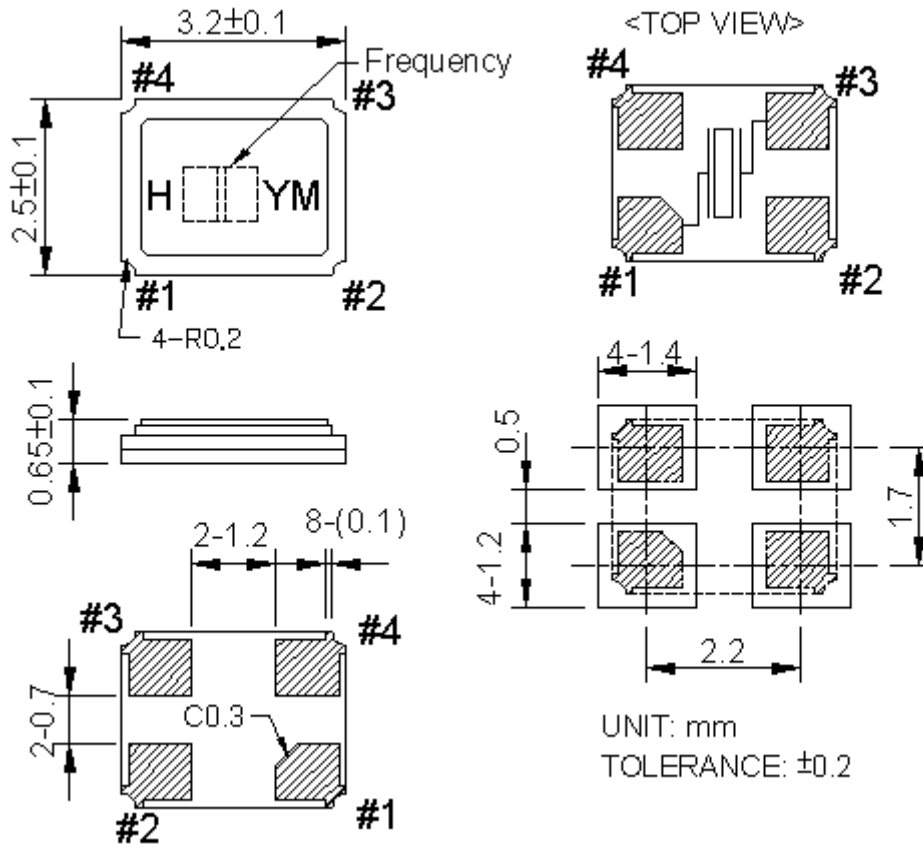

- *Marking should be printed as following:
Logo, Nominal Frequency, Manufactured year & month
- *Nominal frequency = integer only
(ex. 14.31818 MHz \rightarrow 14)
- *Manufacturing Lot No.
(Y: year) ex. 2000 shall be marked as '0' (The last digit of the year)
(M: month) ex. June shall be marked as 'F' (As shown on the Table-1).

Marking : Laser marking.

(Table-1)

Jan.	Feb.	Mar.	Apr.	May.	Jun.	Jul.	Aug.	Sep.	Oct.	Nov.	Dec.
A	B	C	D	E	F	G	H	J	K	L	M

Title HSX321S QUARTZ CRYSTAL SPECIFICATION				Remark THAILAND FACTORY TAIWAN FACTORY				
Date	Confirm	Check	Prepare	Spec. No.			Rev.	Page
2008/09/23	F. S. TSAI	C. L. WANG	U. F. CHEN	X3S026000B71HZ-NHPZ			0	4

HARMONY ELECTRONICS CORP.

3. INSIDE STRUCTURE

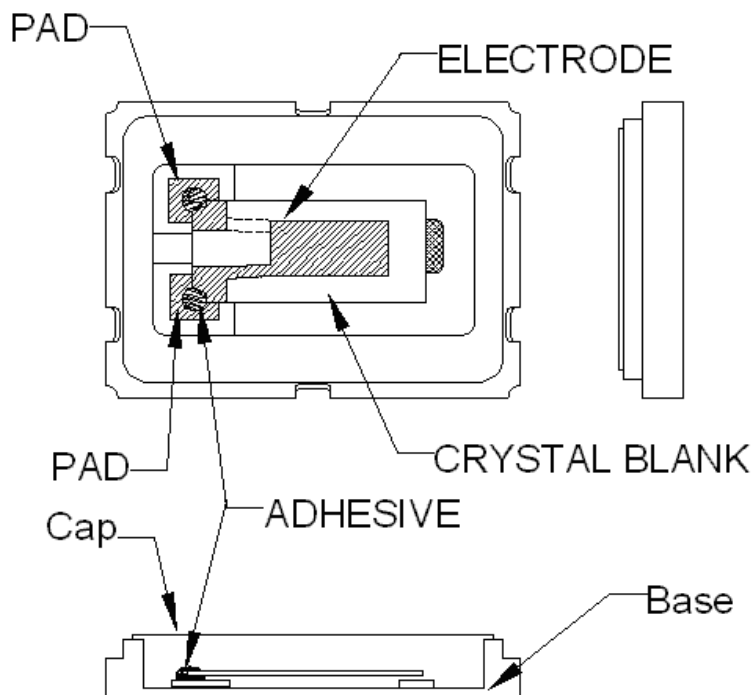

※Reference drawing

(1) Base: Alumina Ceramic (Al_2O_3) Metallized Pad: W Ni Plating Au Plating
(2) Cap: Fe-Ni
(3) Crystal Enclosure Seal: Seal Seam
(4) Crystal Blank Rectangular At-Cut Quartz Crystal Blank
(5) Adhesive Silver Conductive Silicon Resin Adhesive bonding: upper & lower bonding/lower bonding only
(6) Electrode Au
(7) PAD Alumina Ceramic (W. Ni. Au)

The use prohibition chemistry substance of Table 1 of DHE-0204-1 (QA-QM-08) is not included in this item.

Title HSX321S QUARTZ CRYSTAL SPECIFICATION				Remark THAILAND FACTORY TAIWAN FACTORY		
Date	Confirm	Check	Prepare	Spec. No.	Rev.	Page
2008/09/23	F. S. TSAI	C. L. WANG	U. F. CHEN	X3S026000B71HZ-NHPZ	0	5

4. HSX321S EMBOSS CARRIER TAPE & REEL

a.) Dimensions of Carrier Tape

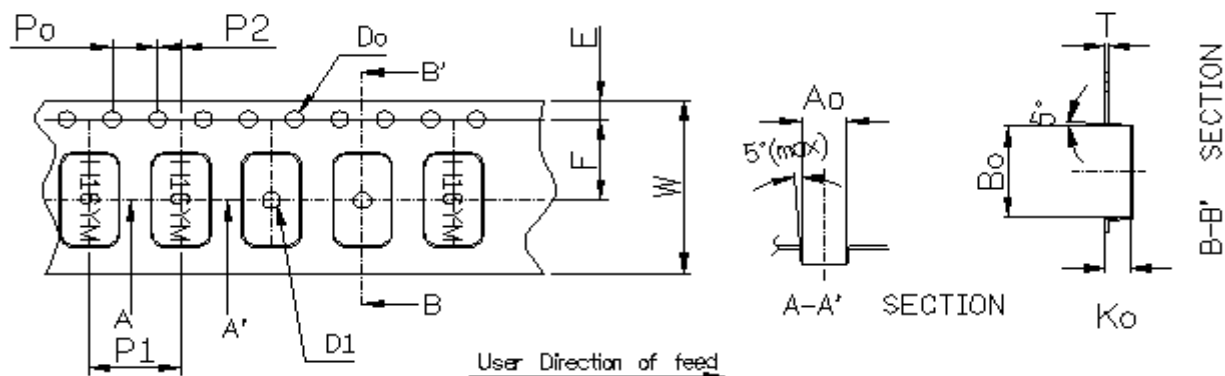

Symbol	Ao	Bo	Ko	Po	P1	P2
Spec	2.70±0.1	3.4±0.1	1.40±0.1	4.0±0.1	4.0±0.1	2.0±0.05
Symbol	E	F	Do	D1	W	T
Spec	1.75±0.1	3.5±0.05	∅1.55±0.05	∅1.0(min)	8.0±0.2	0.25±0.05

b.) Dimensions of Reel

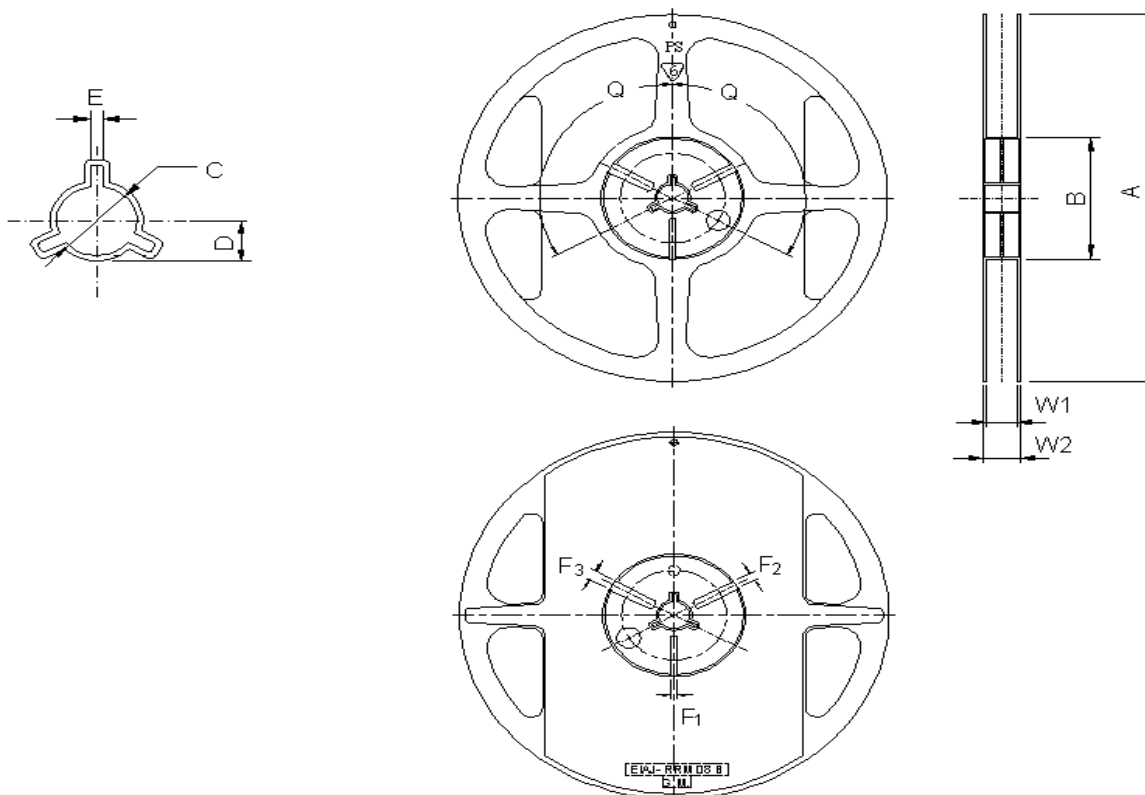

Title **HSX321S**
QUARTZ CRYSTAL SPECIFICATION

Remark **THAILAND FACTORY**
TAIWAN FACTORY

Date	Confirm	Check	Prepare	Spec. No.	Rev.	Page
2008/09/23	F. S. TSAI	C. L. WANG	U. F. CHEN	X3S026000B71HZ-NHPZ	0	6

(Table-2)

(UNIT: mm)

ITEM		MARK	DIMENSIONS · ANGLE	
FLANCE	Diameter	A	ϕ 178+1/-1	
	Inner Width	W1	8.0+/-1.5	
	Outer Width	W2	11.5+/-0.2	
HUB	Out Line diameter		B	ϕ 60+1.0/-0.0
	Center Core slit	Width	F1	3.0+0.5/-0
			F2	4.0+0.5/-0
			F3	5.0+0.5/-0
		Position	q	120deg
	Spindle diameter		C	ϕ 13+/-0.5
Key Ditch	Width	E	2.5+/-0.5/-0	

c.) Storage condition

Temperature: +40deg.C Max.

Relative Humidity: 80% Max.

d.) Standard packing quantity

3,000PCS / REEL

e.) Material of the tape

Tape	Material
Carrier tape	A – PET
Top tape	Polyester

f.) Label contents

- .The type of product
- .Our specification No.
- .Your Part No.
- .Lot No.
- .Nominal Frequency
- .Quantity
- .Our Company Name

Sticks label for every reel.

TYPE	
SPEC NO.	
Parts NO.	
Lot No.	
FREQ.	
Q'TY	(RoHS Compliance)
H.E.ELE. HARMONY ELECTRONICS CORP.	

Title HSX321S QUARTZ CRYSTAL SPECIFICATION				Remark THAILAND FACTORY TAIWAN FACTORY		
Date	Confirm	Check	Prepare	Spec. No.	Rev.	Page
2008/09/23	F. S. TSAI	C. L. WANG	U. F. CHEN	X3S026000B71HZ-NHPZ	0	7

HARMONY ELECTRONICS CORP.

g.) Taping dimension

Leader	Cover-tape	The length of cover-tape in the leader is more than 400 mm including empty embossed area.
	Carrier-tape	After all products were packaged, must remain more than twenty pieces or 400 mm empty area, which should be sealed by cover-tape.
Terminal	Cover-tape	The tip of cover-tape shall be fixed temporary by paper tape and roll around the core of reel one round.
	Carrier-tape	The empty embossed area which are sealed by top cover-tape must remain more the 40 mm.

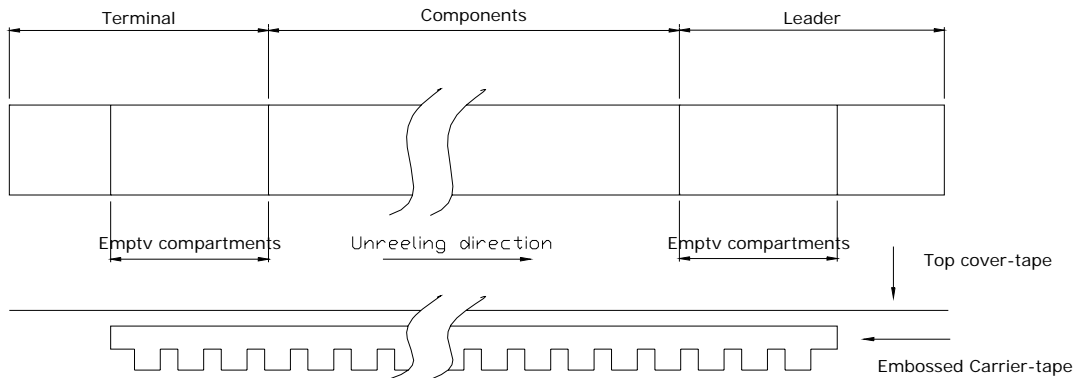

h.) Joint of tape

The carrier-tape and top cover-tape should not be jointed.

i.) Release strength of cover tape

It has to between 0.1N to 0.7N under following condition.

Pulling direction 165° to 180°

Speed 300mm/min.

Otherwise unless specified.

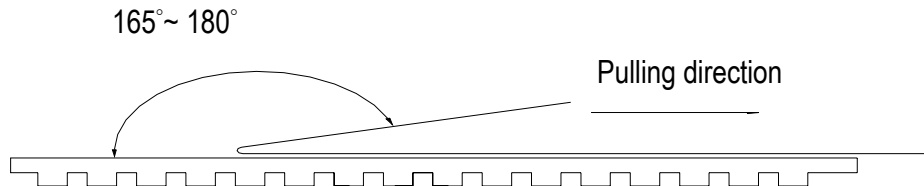

Other standards shall be based on JIS C 0806-1990.

Title HSX321S QUARTZ CRYSTAL SPECIFICATION				Remark THAILAND FACTORY TAIWAN FACTORY		
Date	Confirm	Check	Prepare	Spec. No.	Rev.	Page
2008/09/23	F. S. TSAI	C. L. WANG	U. F. CHEN	X3S026000B71HZ-NHPZ	0	8

5. Mechanical Performance

5.1. Natural Drop

Drop 3 times from the height of 50cm onto min. 30mm thickness hard wooden board
The component shall satisfy requirement of the electrical characteristics.

5.2. Vibration

Frequency 10-55Hz, Sine Wave full amplitude of 1.5mm to X,Y and Z 3 axes, Duration of 2 hours to each axis.
The component shall satisfy requirement of the electrical characteristics.

5.3. Sealing Tightness

Leak Rate 1.0×10^{-8} Pa-m³/sec. Max. measured by Helium leak detector.

5.4. Solderability

After applying ROSIN Flux, dipping in solder bath at 230°C +/-5°C for 5 sec.
Over 90% of terminal shall be covered by solder.

6. Environment Performance

6.1. Humidity

Temperature 60°C +/-2°C, RH 90~95%, Duration of 240 hours
Back to room temperature first, then in 1~2 hours, the component shall be checked.
The component shall satisfy requirement of the electrical characteristics.
No physical damage

6.2. Storage in Low Temperature

-30°C +/-2°C, Duration of 240 hours.
Back to the room temperature first, then in 1~2 hours, the component shall be checked.
The component shall satisfy requirement of the electrical characteristics.
No physical damage

6.3. Storage in High Temperature

+85°C +/-2°C, Duration of 240 hours.
Back to the room temperature first, then in 1~2 hours, the component shall be checked.
The component shall satisfy requirement of the electrical characteristics.
No physical damage

Title HSX321S QUARTZ CRYSTAL SPECIFICATION				Remark THAILAND FACTORY TAIWAN FACTORY		
Date	Confirm	Check	Prepare	Spec. No.	Rev.	Page
2008/09/23	F. S. TSAI	C. L. WANG	U. F. CHEN	X3S026000B71HZ-NHPZ	0	9

6.4. Temperature cycles

-30°C +/- 2°C (30min) ↔ +85°C +/- 2°C (30min) 20 cycles

Back to the room temperature first, then in 1~2 hours, the component shall be checked.

The component shall satisfy requirement of the electrical characteristics.

No physical damage

6.5. VPS

FC-70 (the boiling point: +215°C) Vapor for 30 sec

Back to the room temperature first, then in 1~2 hours, the component shall be checked.

The component shall satisfy requirement of the electrical characteristics.

No physical damage

7. Supplement

7.1. Soldering

7.2. Please stay with our proposed reflow condition and do then soldering 2 times max.

Available for Lead Free Soldering

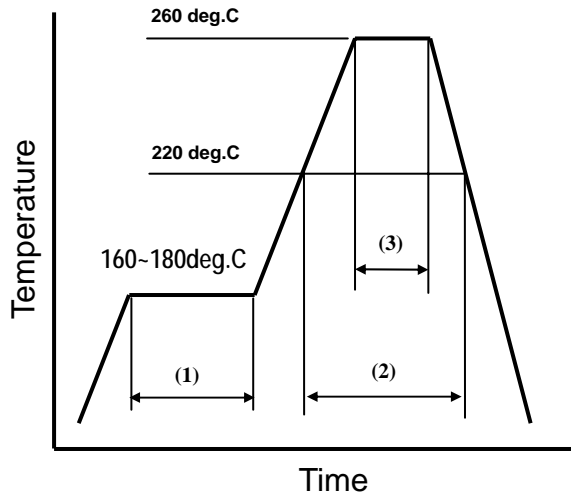

(1)	Preheat	160~180 deg.C	120sec.
(2)	Primary heat	220 deg.C	60sec.
(3)	Peak	260 deg.C	10sec. Max.

Title HSX321S QUARTZ CRYSTAL SPECIFICATION				Remark THAILAND FACTORY TAIWAN FACTORY		
Date	Confirm	Check	Prepare	Spec. No.	Rev.	Page
2008/09/23	F. S. TSAI	C. L. WANG	U. F. CHEN	X3S026000B71HZ-NHPZ	0	10

7.3.Land pattern layout(Example)

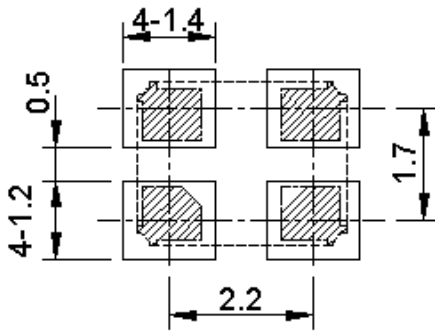

7.4.Solder iron (Example)

Bit temp.:350°C max.,Time:3sec max. ,Each terminal solder a 1 time max.

7.5.Mounting

This component is designed for automatic insertion.

However, you are requested to do the trial with your insertion machine in order to be sure of proper operation and no damage of component.

Please pay attention to board warp which may damage the component and cause Soldering Process.

7.6.Cleaning

Cleaning liquid which corrodes Nickel shall not be used

It may cause the problem on the surface, color, marking etc.

Ultra-sonic cleaning is possible, however, you are requested to check on your board.

Because we only checked as single unit.

7.7.Storage

Please keep away from high temperature and high humidity ,which may cause put solderbility. No direct Sunlight, No dew as well.

Title HSX321S QUARTZ CRYSTAL SPECIFICATION				Remark THAILAND FACTORY TAIWAN FACTORY		
Date	Confirm	Check	Prepare	Spec. No.	Rev.	Page
2008/09/23	F. S. TSAI	C. L. WANG	U. F. CHEN	X3S026000B71HZ-NHPZ	0	11

8. Flow Chard

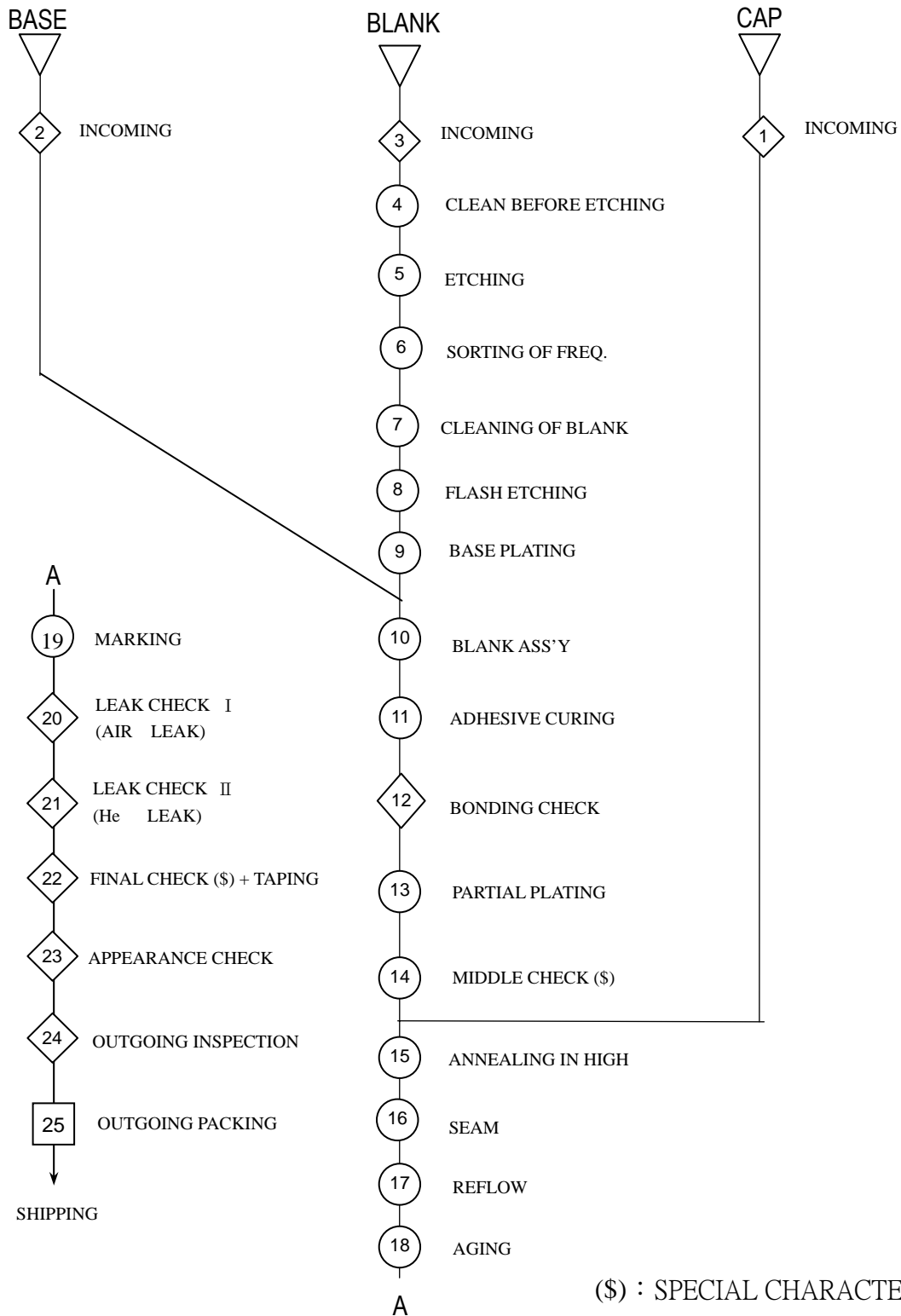

Tittle HSX321S QUARTZ CRYSTAL SPECIFICATION				Remark THAILAND FACTORY TAIWAN FACTORY		
Date	Confirm	Check	Prepare	Spec. No.	Rev.	Page
2008/09/23	F. S. TSAI	C. L. WANG	U. F. CHEN	X3S026000B71HZ-NHPZ	0	12

9. Environmental Workload Chemical Substance Components List

Environmental Workload Chemical Substance Components List		
TYPE	H(D)SX321S	
PERCENTAGE	19(mg)	ppm
Chemical Substance Components		
Si	0.0437	2,300
Au	0.1463	7,700
Co & Co Compound	1.1286	59,400
Mo & Mo Compound	0.0380	2,000
Ag	0.3952	20,800
Cu	0.1102	5,800
Cr & Cr Compound	0.0380	2,000
Al	4.7234	248,600
Mn & Mn Compound	0.0228	1,200
W & W Compound	0.1843	9,700
Ni & Ni Compound	2.8424	149,600
Fe	3.8437	202,300

Title HSX321S QUARTZ CRYSTAL SPECIFICATION				Remark THAILAND FACTORY TAIWAN FACTORY		
Date	Confirm	Check	Prepare	Spec. No.	Rev.	Page
2008/09/23	F. S. TSAI	C. L. WANG	U. F. CHEN	X3S026000B71HZ-NHPZ	0	13

EXCEL EXPORT PRINTOUT FORMAT

Run Date : 12-09-2008 9:08 am

S&A 250B: 9.40 Report: 4.60

Description:

Reference Fr: 26,000,000.00 (Using Measured FL)

Power: 100.00 uW Into 20.0 ohms

PL: No Load CL: 10.90 pF

Crystal	First Failure	FR	FL	FL	RR	C0	C1	C0/C1	L	Q	TS	RLD2	DLD2	FDLD	DLDH2	FDLDH
		Hz	Hz	ppm	Ohms	pF	fF		mH	k	ppm/pF	Ohms	Ohms	ppm	Ohms	ppm
High Limit					40.0	2.00						40.0	3.0	2.0	3.0	2.0
Low Limit																
1	PASS	25996184.5	26000000.8	0.0	15.2	1.05	3.47	303.6	10.8	116.3	12.1	15.1	0.3	0.6	0.2	0.0
2	PASS	25995973.5	25999995.4	-0.2	13.5	1.12	3.68	304.7	10.2	123.8	12.7	13.4	0.3	1.0	0.2	0.0
3	PASS	25996193.8	26000021.4	0.8	19.2	1.05	3.48	302.1	10.8	91.8	12.2	20.4	1.8	0.9	1.4	0.2
4	PASS	25995941.1	26000022.4	0.9	13.1	1.09	3.72	292.8	10.1	125.5	12.9	12.9	0.4	0.7	0.2	0.2
5	PASS	25996031.5	26000015.9	0.6	14.1	1.11	3.64	305.0	10.3	119.4	12.6	14.0	0.3	1.1	0.2	0.0
6	PASS	25995883.8	25999750.2	-9.6	13.8	1.11	3.53	315.1	10.6	126.0	12.2	13.7	0.3	1.4	0.2	0.0
7	PASS	25995913.6	25999773.9	-8.7	13.2	1.08	3.52	307.0	10.7	131.5	12.3	13.2	0.3	1.0	0.2	0.0
8	PASS	25995920.0	25999798.2	-7.8	13.9	1.12	3.55	315.5	10.6	124.6	12.3	14.0	0.7	1.6	0.4	0.1
9	PASS	25995934.3	25999782.6	-8.4	14.2	1.12	3.52	318.0	10.7	122.5	12.2	14.5	0.7	1.7	0.3	0.1
10	PASS	25995916.5	25999792.9	-8.0	16.0	1.06	3.52	301.9	10.6	108.9	12.3	17.6	2.0	0.6	1.3	0.1
11	PASS	25996196.0	26000267.6	10.3	9.4	1.16	3.74	311.3	10.0	174.7	12.8	9.3	0.3	1.4	0.2	0.0
12	PASS	25996310.1	26000258.6	9.9	8.3	1.11	3.61	307.4	10.4	203.8	12.5	8.3	0.4	1.5	0.4	0.1
13	PASS	25996189.3	26000276.2	10.6	9.2	1.13	3.74	301.1	10.0	177.8	12.9	9.2	0.3	1.2	0.3	0.0
14	PASS	25996276.0	26000275.3	10.6	8.7	1.11	3.66	304.3	10.3	191.8	12.7	8.6	0.3	1.5	0.3	0.0
15	PASS	25996283.1	26000271.2	10.4	12.2	1.11	3.64	303.7	10.3	137.8	12.6	12.1	0.2	1.1	0.2	0.0

MAX	25996310	26000276	10.6	19.2	1.16	3.74	318.0	10.8	203.8	12.9	20.4	2.0	1.7	1.4	0.2
MIN	25995884	25999750	-9.6	8.3	1.05	3.47	292.8	10.0	91.8	12.1	8.3	0.2	0.6	0.2	0.0
X-bar	25996076	26000020	0.8	12.9	1.10	3.60	306.2	10.4	138.4	12.5	13.1	0.6	1.2	0.4	0.1
3S	477.4	622.9	24.0	8.9	0.1	0.3	19.6	0.8	97.9	0.9	10.0	1.7	1.1	1.2	0.2

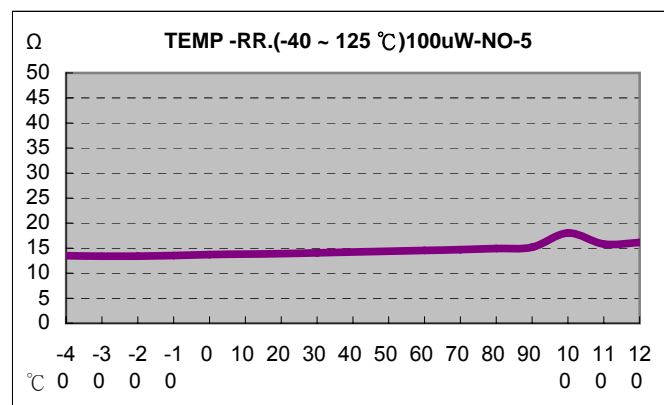
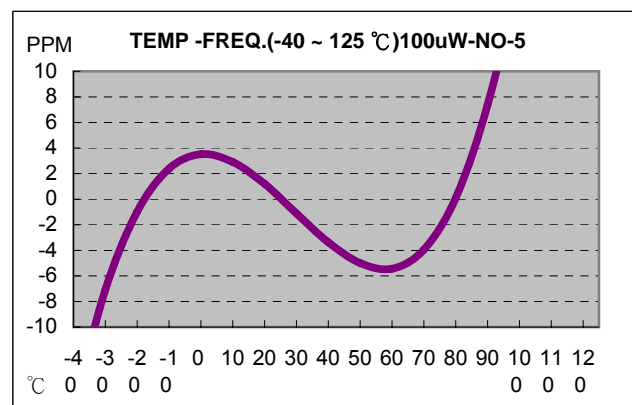
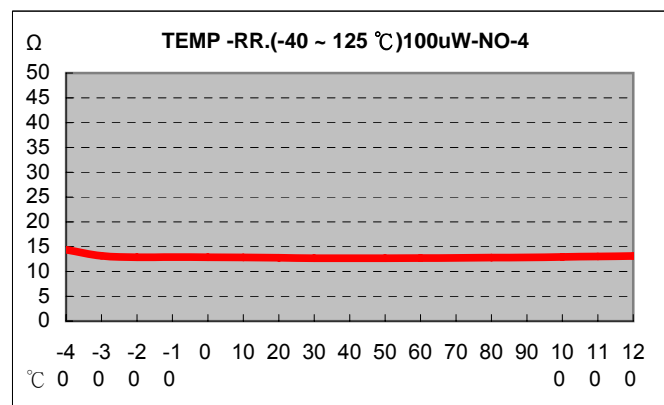
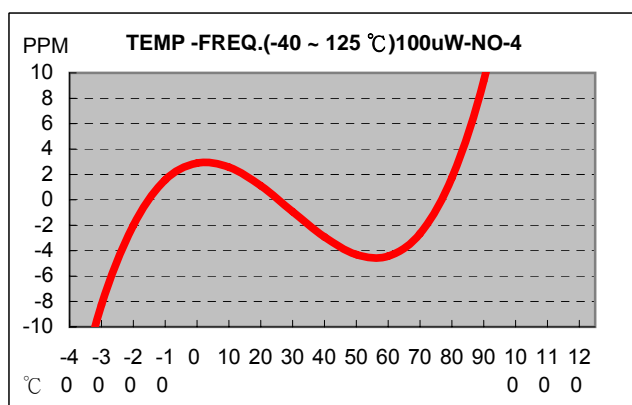
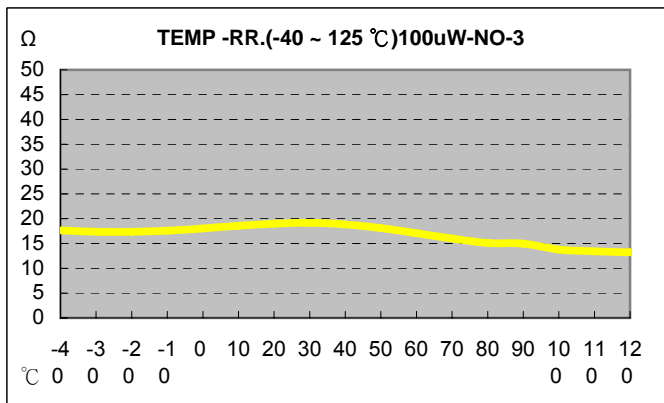
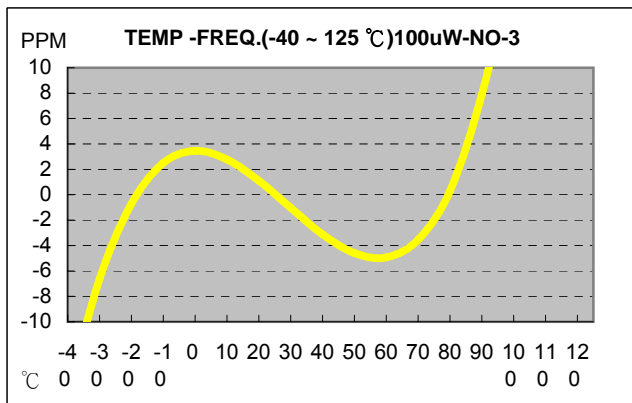
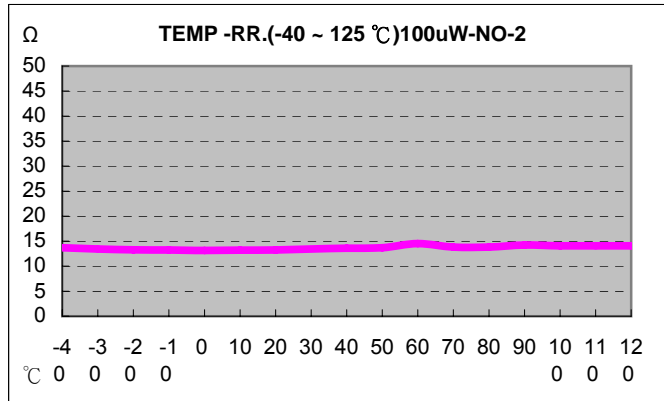
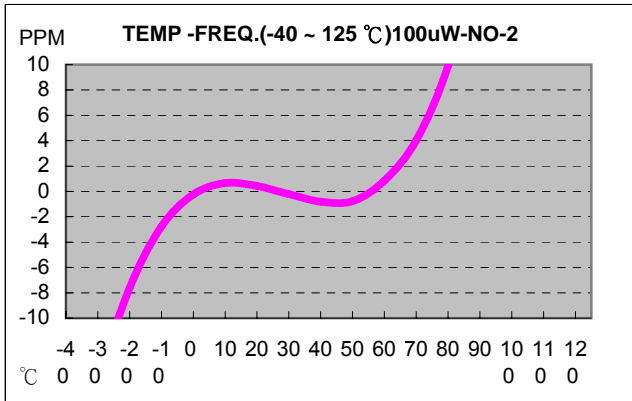
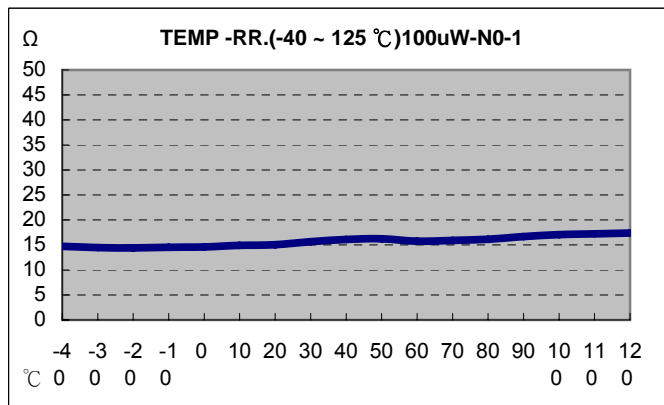
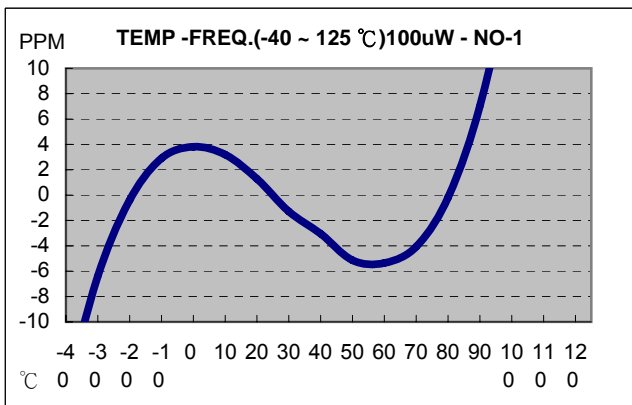

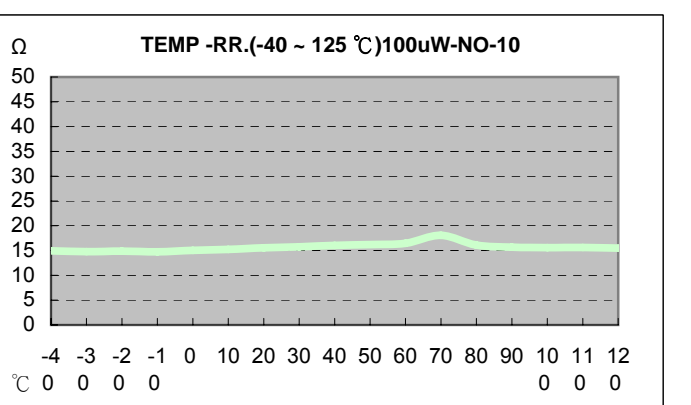
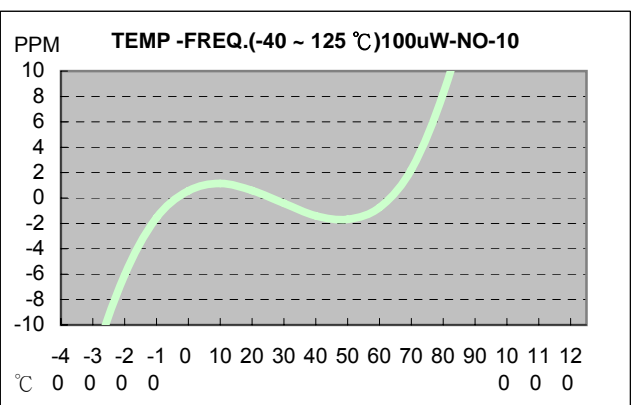
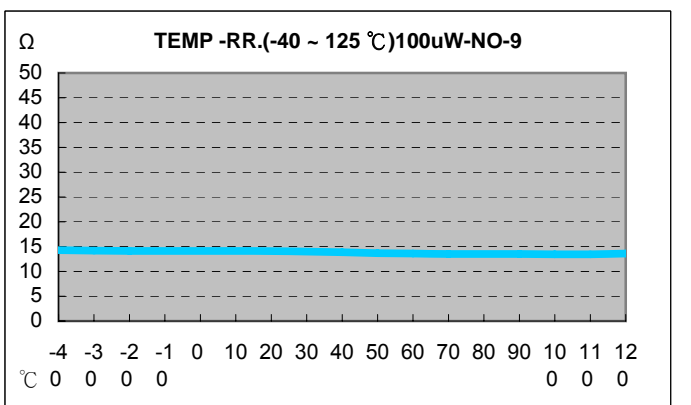
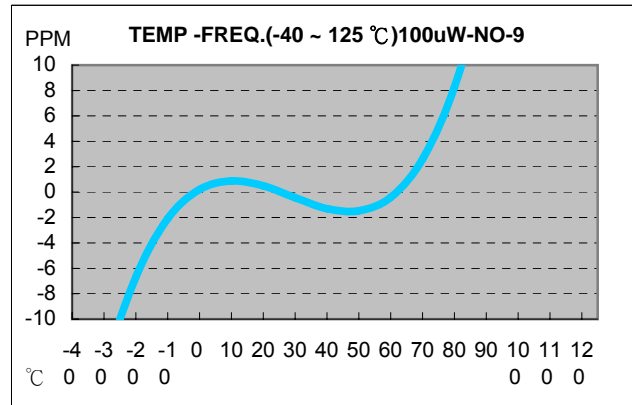
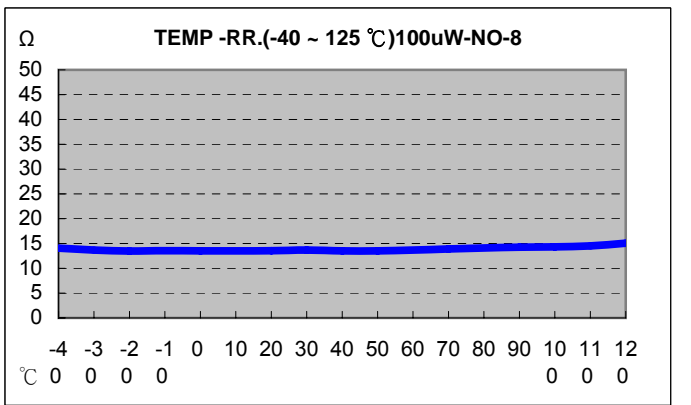
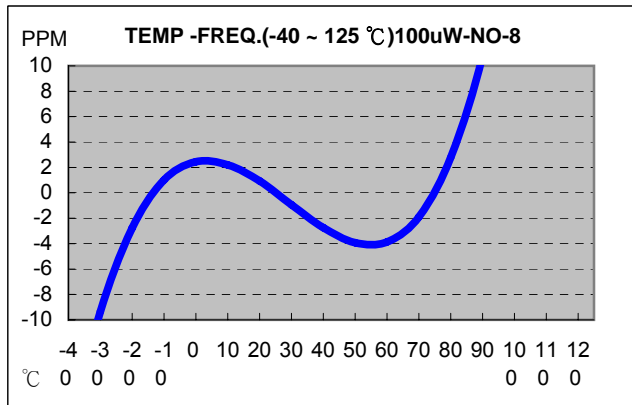
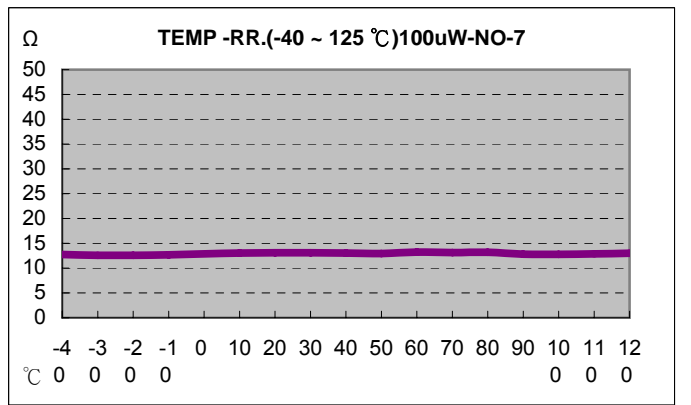
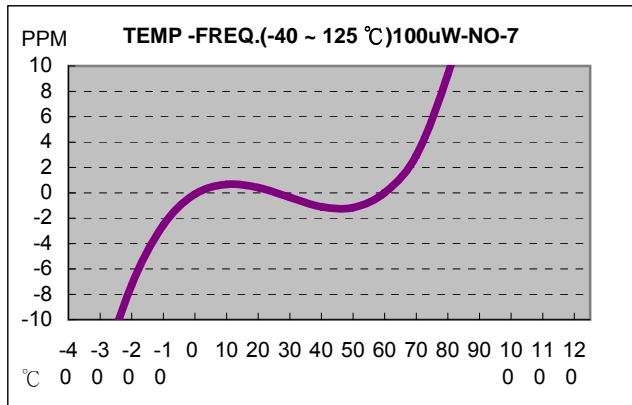
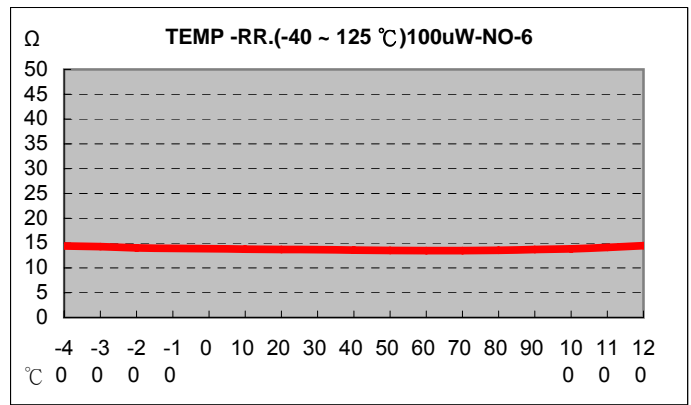
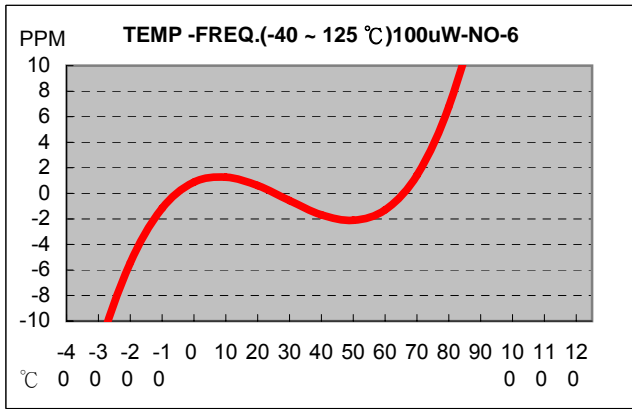

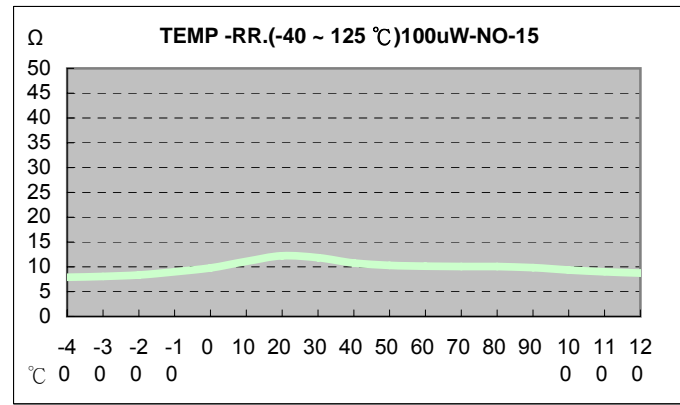
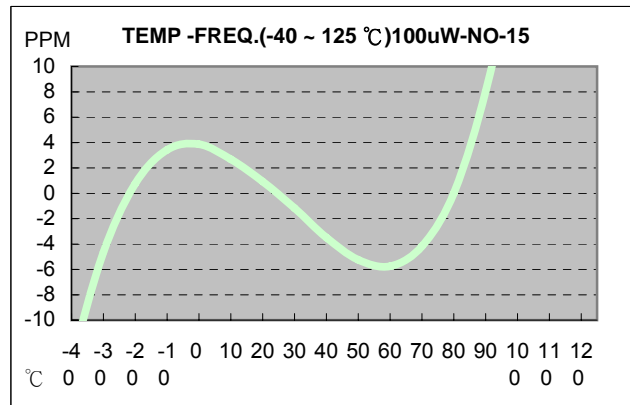
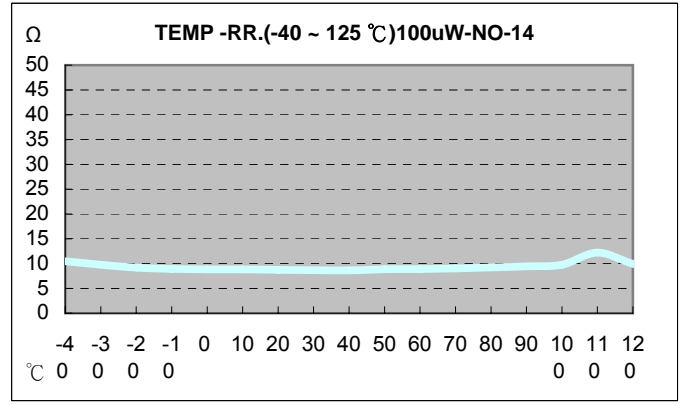
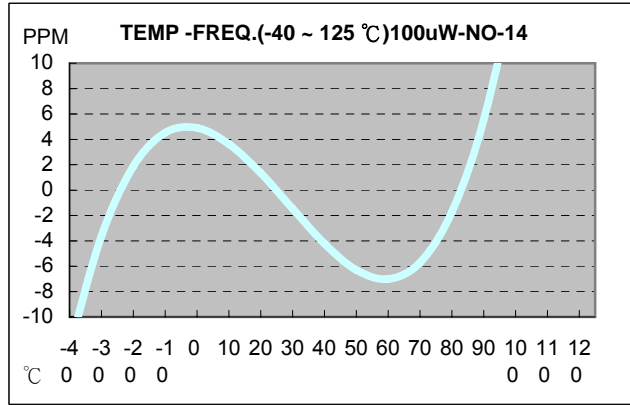
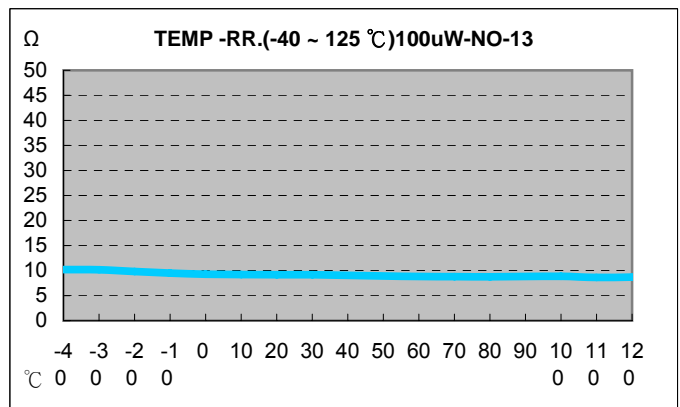
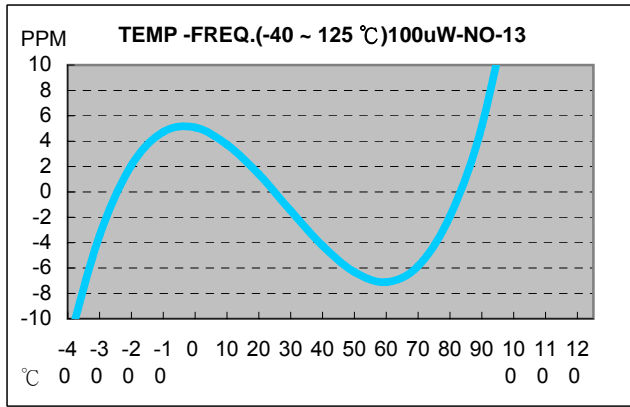
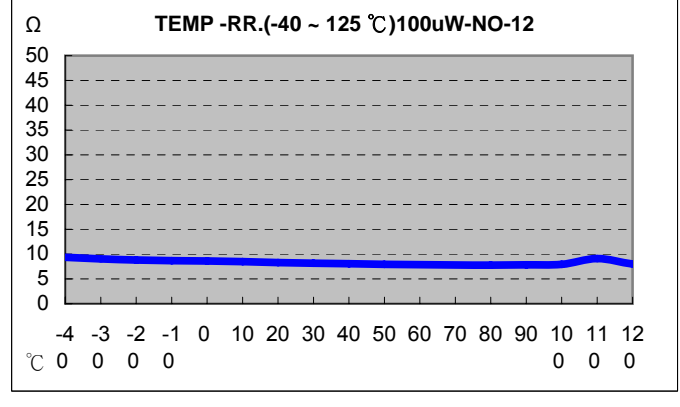
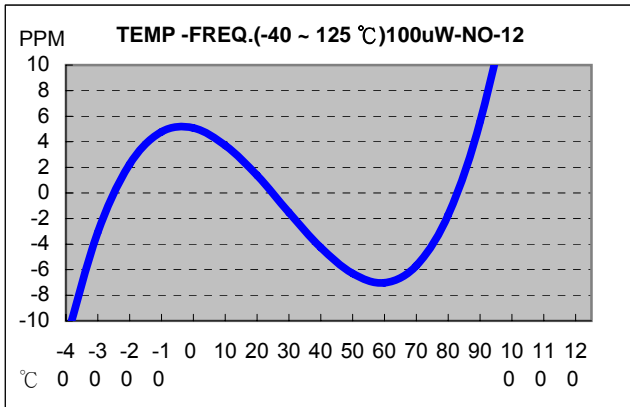
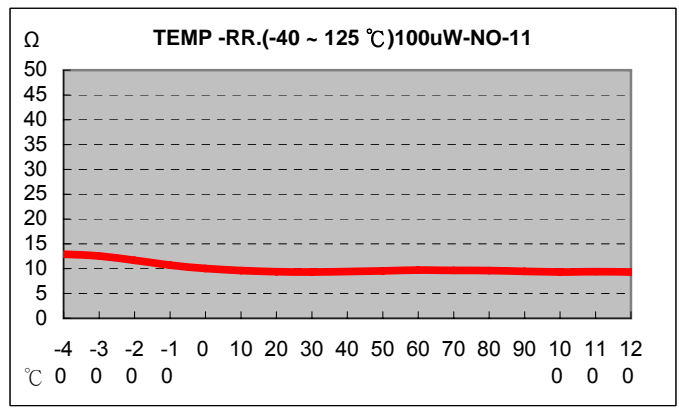
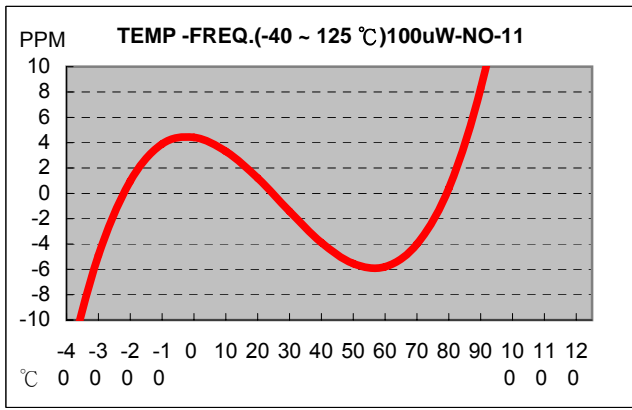

Test Report

DAISHINKU CORP.(KDS)/HARMONY ELECTRONICS CORPORATION.
NO.39, HUADONG RD., DALIAO TOWNSHIP, KAOHSIUNG COUNTY 831,
TAIWAN (R.O.C.)

Report No. : KA/2008/70987
Date : 2008/07/16
Page : 1 of 8



The following sample(s) was/were submitted and identified by/on behalf of the client as :

Sample Description : CRYSTAL OSCILLATOKS
Style/Item No. : HSX321S,DSX321S(Au)
Sample Receiving Date : 2008/07/10
Testing Period : 2008/07/10 TO 2008/7/16

=====
Test Result(s) : - Please see the next page(s) -

Katherine Ho / Supervisor
Signed for and on behalf of
SGS Taiwan Limited

Unless otherwise stated the results shown in this test report refer only to the sample(s) tested. This test report cannot be reproduced, except in full, without prior written permission of the Company. 除非另有說明，此報告結果僅對測試之樣品負責。本報告未經本公司書面許可，不可部份複製。
This Test Report is issued by the Company under its General Conditions of Service printed overleaf or available on request and accessible at http://www.sgs.com/terms_and_conditions.htm. Attention is drawn to the limitation of liability, indemnification and jurisdiction issues defined therein. Any holder of this Test Report is advised that information contained hereon reflects the Company's findings at the time of its intervention only and within the limits of Client's instructions, if any. The Company's sole responsibility is to its Client and this document does not exonerate parties to a transaction from exercising all their rights and obligations under the transaction documents. Any unauthorized alteration, forgery or falsification of the content or appearance of this document is unlawful and offenders may be prosecuted to the fullest extent of the law.



Test Report

DAISHINKU CORP.(KDS)/HARMONY ELECTRONICS CORPORATION.
NO.39, HUADONG RD., DALIAO TOWNSHIP, KAOHSIUNG COUNTY 831,
TAIWAN (R.O.C.)

Report No. : KA/2008/70987
Date : 2008/07/16
Page : 2 of 8



Test Result(s)

PART NAME NO.1 : MIX TEST:BROWN+GOLD+SILVER CRYSTAL OSCILLATOKS

Test Item (s)	Unit	Method	MDL	Result
				No. 1
Cadmium (Cd)	mg/kg	With reference to IEC 62321/2nd CDV (111/95/CDV). Determination of Cadmium by ICP-AES.	2	n.d.
Hexavalent Chromium Cr(VI) by alkaline extraction	mg/kg	With reference to IEC 62321/2nd CDV (111/95/CDV). Determination of Hexavalent Chromium for non-metallic samples by UV/Vis Spectrometry.	2	n.d.
Mercury (Hg)	mg/kg	With reference to IEC 62321/2nd CDV (111/95/CDV). Determination of Mercury by ICP-AES.	2	n.d.
Lead (Pb)	mg/kg	With reference to IEC 62321/2nd CDV (111/95/CDV). Determination of Lead by ICP-AES.	2	n.d.
PERFLUOROOCCTANE SULFONATES (PFOS)	mg/kg	With reference to US EPA 3540C : 1996 method for PFOS Content. Analysis was performed by LC/MS.	10	n.d.
Sum of PBBs	mg/kg	With reference to IEC 62321/2nd CDV (111/95/CDV). Determination of PBBs and PBDEs by GC/MS.	-	n.d.
Monobromobiphenyl			5	n.d.
Dibromobiphenyl			5	n.d.
Tribromobiphenyl			5	n.d.
Tetrabromobiphenyl			5	n.d.
Pentabromobiphenyl			5	n.d.
Hexabromobiphenyl			5	n.d.
Heptabromobiphenyl			5	n.d.
Octabromobiphenyl			5	n.d.
Nonabromobiphenyl			5	n.d.
Decabromobiphenyl			5	n.d.

Unless otherwise stated the results shown in this test report refer only to the sample(s) tested. This test report cannot be reproduced, except in full, without prior written permission of the Company. 除非另有說明，此報告結果僅對測試之樣品負責。本報告未經本公司書面許可，不可部份複製。

This Test Report is issued by the Company under its General Conditions of Service printed overleaf or available on request and accessible at http://www.sgs.com/terms_and_conditions.htm. Attention is drawn to the limitation of liability, indemnification and jurisdiction issues defined therein. Any holder of this Test Report is advised that information contained herein reflects the Company's findings at the time of its intervention only and within the limits of Client's instructions, if any. The Company's sole responsibility is to its Client and this document does not exonerate parties to a transaction from exercising all their rights and obligations under the transaction documents. Any unauthorized alteration, forgery or falsification of the content or appearance of this document is unlawful and offenders may be prosecuted to the fullest extent of the law.

Test Report

DAISHINKU CORP.(KDS)/HARMONY ELECTRONICS CORPORATION.
NO.39, HUADONG RD., DALIAO TOWNSHIP, KAOHSIUNG COUNTY 831,
TAIWAN (R.O.C.)

Report No. : KA/2008/70987
Date : 2008/07/16
Page : 3 of 8



Test Item (s)	Unit	Method	MDL	Result
				No. 1
Sum of PBDEs			-	n.d.
Monobromodiphenyl ether	mg/kg	With reference to IEC 62321/2nd CDV (111/95/CDV). Determination of PBBs and PBDEs by GC/MS.	5	n.d.
Dibromodiphenyl ether			5	n.d.
Tribromodiphenyl ether			5	n.d.
Tetrabromodiphenyl ether			5	n.d.
Pentabromodiphenyl ether			5	n.d.
Hexabromodiphenyl ether			5	n.d.
Heptabromodiphenyl ether			5	n.d.
Octabromodiphenyl ether			5	n.d.
Nonabromodiphenyl ether			5	n.d.
Decabromodiphenyl ether			5	n.d.
Halogen			---	---
Halogen-Chlorine (Cl) (CAS No.: 022537-15-1)	mg/kg	With reference to BS EN 14582 . Analysis was performed by IC method for Chlorine content.	50	n.d.
Halogen-Fluorine (F) (CAS No.: 014762-94-8)	mg/kg	With reference to BS EN 14582 . Analysis was performed by IC method for Fluorine content.	50	n.d.
Halogen-Bromine (Br) (CAS No.: 010097-32-2)	mg/kg	With reference to BS EN 14582 . Analysis was performed by IC method for Bromine content.	50	n.d.
Halogen-Iodine (I) (CAS No.: 014362-44-8)	mg/kg	With reference to BS EN 14582 . Analysis was performed by IC method for Iodine content.	50	n.d.

- Note :
1. mg/kg = ppm
 2. n.d. = Not Detected
 3. MDL = Method Detection Limit
 4. The exemption of DecaBDE in polymeric application according 2005/717/EC was overruled by the European Court of Justice by its decision of 01.04.2008. Subsequently DecaBDE will be included in the sum of PBDE after 01.07.2008
 5. " - " = Not Regulated
 6. " --- " = Not Conducted

Unless otherwise stated the results shown in this test report refer only to the sample(s) tested. This test report cannot be reproduced, except in full, without prior written permission of the Company. 除非另有說明，此報告結果僅對測試之樣品負責。本報告未經本公司書面許可，不可部份複製。

This Test Report is issued by the Company under its General Conditions of Service printed overleaf or available on request and accessible at http://www.sgs.com/terms_and_conditions.htm. Attention is drawn to the limitation of liability, indemnification and jurisdiction issues defined therein. Any holder of this Test Report is advised that information contained herein reflects the Company's findings at the time of its intervention only and within the limits of Client's instructions, if any. The Company's sole responsibility is to its Client and this document does not exonerate parties to a transaction from exercising all their rights and obligations under the transaction documents. Any unauthorized alteration, forgery or falsification of the content or appearance of this document is unlawful and offenders may be prosecuted to the fullest extent of the law.

Test Report

DAISHINKU CORP.(KDS)/HARMONY ELECTRONICS CORPORATION.
NO.39, HUADONG RD., DALIAO TOWNSHIP, KAOHSIUNG COUNTY 831,
TAIWAN (R.O.C.)

Report No. : KA/2008/70987
Date : 2008/07/16
Page : 4 of 8

- 1) These samples were dissolved totally by pre-conditioning method according to below flow chart.
(Cr6+ test method excluded)
- 2) Name of the person who made measurement: Hungming Li
- 3) Name of the person in charge of measurement: Ray Chang

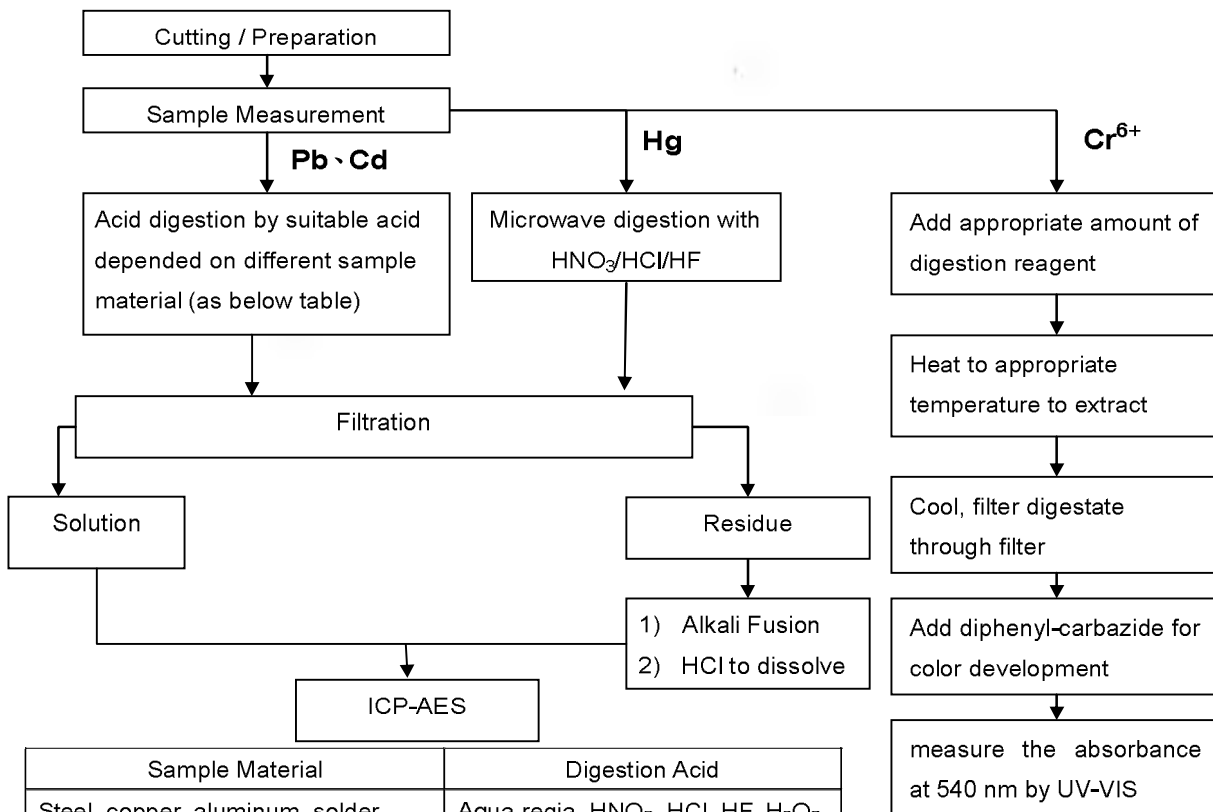

Sample Material	Digestion Acid
Steel, copper, aluminum, solder	Aqua regia, HNO ₃ , HCl, HF, H ₂ O ₂
Glass	HNO ₃ /HF
Gold, platinum, palladium, ceramic	Aqua regia
Silver	HNO ₃
Plastic	H ₂ SO ₄ , H ₂ O ₂ , HNO ₃ , HCl
Others	Any acid to total digestion

Unless otherwise stated the results shown in this test report refer only to the sample(s) tested. This test report cannot be reproduced, except in full, without prior written permission of the Company. 除非另有說明，此報告結果僅對測試之樣品負責。本報告未經本公司書面許可，不可部份複製。
This Test Report is issued by the Company under its General Conditions of Service printed overleaf or available on request and accessible at http://www.sgs.com/terms_and_conditions.htm. Attention is drawn to the limitation of liability, indemnification and jurisdiction issues defined therein. Any holder of this Test Report is advised that information contained hereon reflects the Company's findings at the time of its intervention only and within the limits of Client's instructions, if any. The Company's sole responsibility is to its Client and this document does not exonerate parties to a transaction from exercising all their rights and obligations under the transaction documents. Any unauthorized alteration, forgery or falsification of the content or appearance of this document is unlawful and offenders may be prosecuted to the fullest extent of the law.

Test Report

DAISHINKU CORP.(KDS)/HARMONY ELECTRONICS CORPORATION.
 NO.39, HUADONG RD., DALIAO TOWNSHIP, KAOHSIUNG COUNTY 831,
 TAIWAN (R.O.C.)

Report No. : KA/2008/70987
 Date : 2008/07/16
 Page : 5 of 8



PBB/PBDE analytical FLOW CHART

1) Name of the person who made measurement: Anson Tsao

2) Name of the person in charge of measurement: Ray Chang

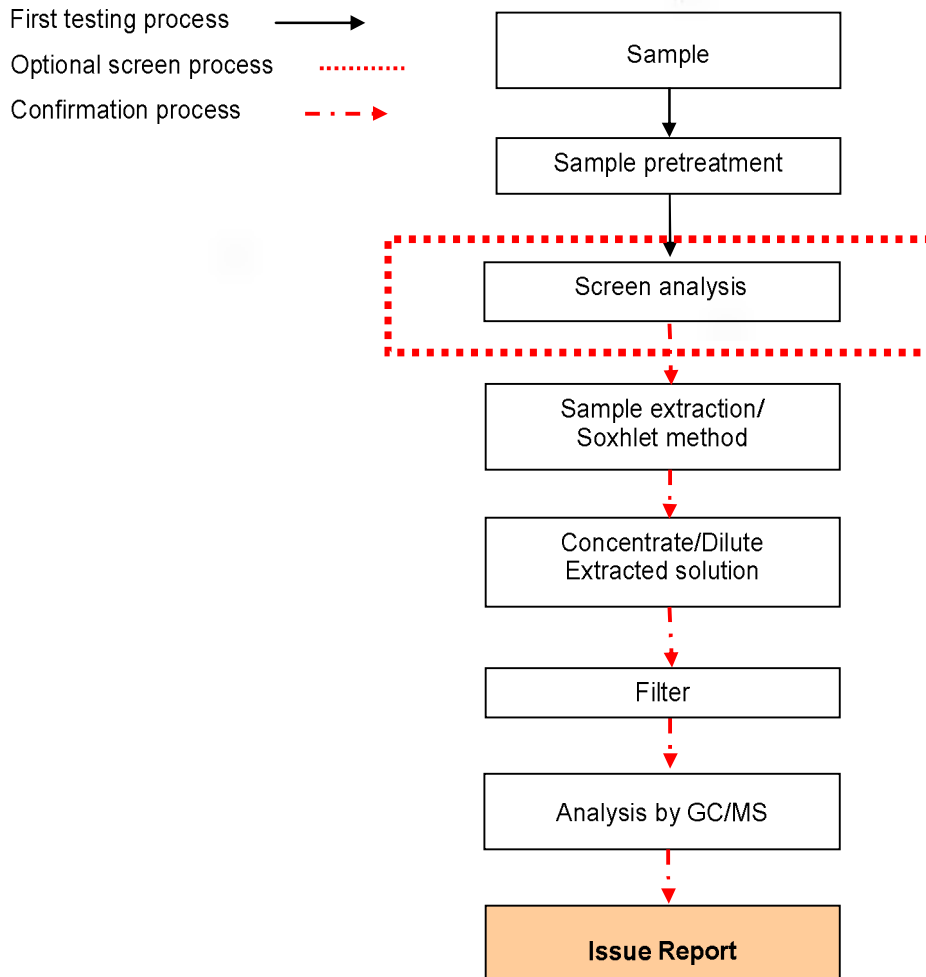

Unless otherwise stated the results shown in this test report refer only to the sample(s) tested. This test report cannot be reproduced, except in full, without prior written permission of the Company. 除非另有說明，此報告結果僅對測試之樣品負責。本報告未經本公司書面許可，不可部份複製。

This Test Report is issued by the Company under its General Conditions of Service printed overleaf or available on request and accessible at http://www.sgs.com/terms_and_conditions.htm. Attention is drawn to the limitation of liability, indemnification and jurisdiction issues defined therein. Any holder of this Test Report is advised that information contained hereon reflects the Company's findings at the time of its intervention only and within the limits of Client's instructions, if any. The Company's sole responsibility is to its Client and this document does not exonerate parties to a transaction from exercising all their rights and obligations under the transaction documents. Any unauthorized alteration, forgery or falsification of the content or appearance of this document is unlawful and offenders may be prosecuted to the fullest extent of the law.

Test Report

DAISHINKU CORP.(KDS)/HARMONY ELECTRONICS CORPORATION.
NO.39, HUADONG RD., DALIAO TOWNSHIP, KAOHSIUNG COUNTY 831,
TAIWAN (R.O.C.)

Report No. : KA/2008/70987
Date : 2008/07/16
Page : 6 of 8



Analytical flow chart of halogen content

- 1) Name of the person who made measurement: Hungming Li
- 2) Name of the person in charge of measurement: Ray Chang

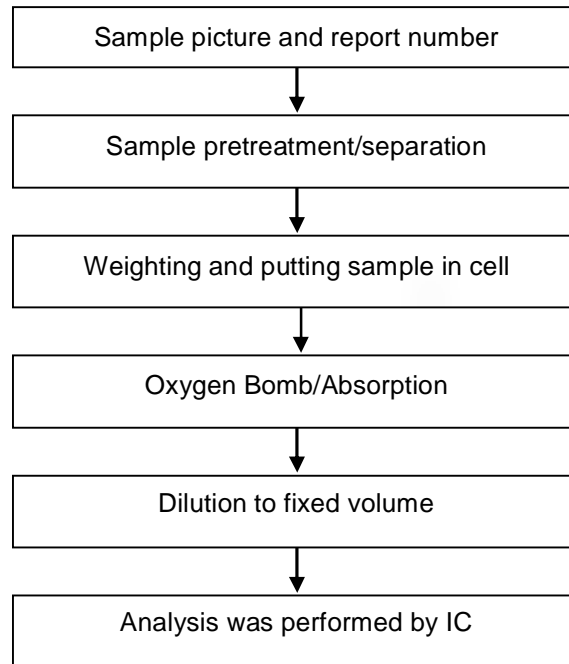

Unless otherwise stated the results shown in this test report refer only to the sample(s) tested. This test report cannot be reproduced, except in full, without prior written permission of the Company. 除非另有說明，此報告結果僅對測試之樣品負責。本報告未經本公司書面許可，不可部份複製。

This Test Report is issued by the Company under its General Conditions of Service printed overleaf or available on request and accessible at http://www.sgs.com/terms_and_conditions.htm. Attention is drawn to the limitation of liability, indemnification and jurisdiction issues defined therein. Any holder of this Test Report is advised that information contained hereon reflects the Company's findings at the time of its intervention only and within the limits of Client's instructions, if any. The Company's sole responsibility is to its Client and this document does not exonerate parties to a transaction from exercising all their rights and obligations under the transaction documents. Any unauthorized alteration, forgery or falsification of the content or appearance of this document is unlawful and offenders may be prosecuted to the fullest extent of the law.

Test Report

DAISHINKU CORP.(KDS)/HARMONY ELECTRONICS CORPORATION.
 NO.39, HUADONG RD., DALIAO TOWNSHIP, KAOHSIUNG COUNTY 831,
 TAIWAN (R.O.C.)

Report No. : KA/2008/70987

Date : 2008/07/16

Page : 7 of 8



Analytical flow chart of PFOS content

- 1) Name of the person who made measurement: Anson Tsao
- 2) Name of the person in charge of measurement: Ray Chang

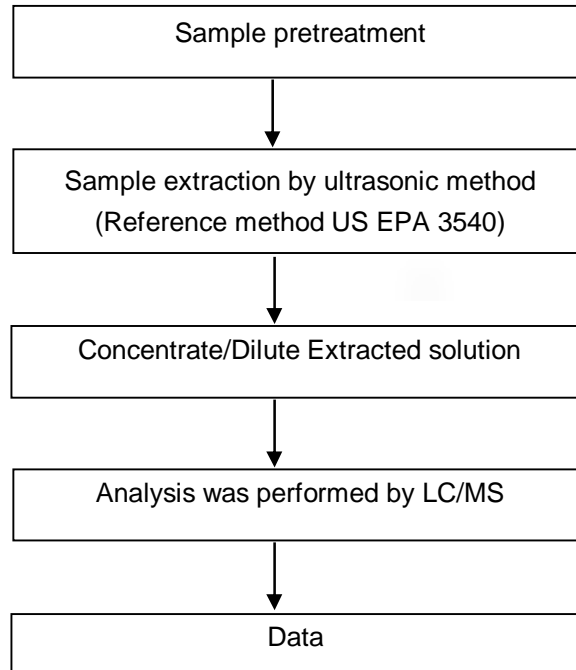

Unless otherwise stated the results shown in this test report refer only to the sample(s) tested. This test report cannot be reproduced, except in full, without prior written permission of the Company. 除非另有說明，此報告結果僅對測試之樣品負責。本報告未經本公司書面許可，不可部份複製。

This Test Report is issued by the Company under its General Conditions of Service printed overleaf or available on request and accessible at http://www.sgs.com/terms_and_conditions.htm. Attention is drawn to the limitation of liability, indemnification and jurisdiction issues defined therein. Any holder of this Test Report is advised that information contained herein reflects the Company's findings at the time of its intervention only and within the limits of Client's instructions, if any. The Company's sole responsibility is to its Client and this document does not exonerate parties to a transaction from exercising all their rights and obligations under the transaction documents. Any unauthorized alteration, forgery or falsification of the content or appearance of this document is unlawful and offenders may be prosecuted to the fullest extent of the law.

Test Report

DAISHINKU CORP.(KDS)/HARMONY ELECTRONICS CORPORATION.
NO.39, HUADONG RD., DALIAO TOWNSHIP, KAOHSIUNG COUNTY 831,
TAIWAN (R.O.C.)

Report No. : KA/2008/70987

Date : 2008/07/16

Page : 8 of 8



** End of Report **

Unless otherwise stated the results shown in this test report refer only to the sample(s) tested. This test report cannot be reproduced, except in full, without prior written permission of the Company. 除非另有說明，此報告結果僅對測試之樣品負責。本報告未經本公司書面許可，不可部份複製。

This Test Report is issued by the Company under its General Conditions of Service printed overleaf or available on request and accessible at http://www.sgs.com/terms_and_conditions.htm. Attention is drawn to the limitation of liability, indemnification and jurisdiction issues defined therein. Any holder of this Test Report is advised that information contained hereon reflects the Company's findings at the time of its intervention only and within the limits of Client's instructions, if any. The Company's sole responsibility is to its Client and this document does not exonerate parties to a transaction from exercising all their rights and obligations under the transaction documents. Any unauthorized alteration, forgery or falsification of the content or appearance of this document is unlawful and offenders may be prosecuted to the fullest extent of the law.

X-ON Electronics

Largest Supplier of Electrical and Electronic Components

Click to view similar products for [Crystals](#) category:

Click to view products by [Harmony](#) manufacturer:

Other Similar products are found below :

[CX3225GB25000M0PPSZ1](#) [718-13.2-1](#) [MC405 32.0000K-R3:PURE SN](#) [7A-40.000MAAE-T](#) [FL2000085](#) [99-BU](#) [9B-15.360MBBK-B](#) [9C-7.680MBBK-T](#) [H10S-12.000-18-EXT-TR](#) [ABC2-6.000MHZ-D4Z-T](#) [ABLS-20.000MHZ-D2-T](#) [ABS071-32.768KHZ-6-T](#) [R38-32.768-12.5-5PPM-NPB](#) [BTD1062E05A-513](#) [21U15A-21.4MHZ](#) [RTX-781DF1-S-20.950](#) [LFXTAL066198Cutt](#) [9C-14.31818MBBK-T](#) [A-11.000MHZ-27](#) [ABL-27.000MHZ-B4Y-T](#) [ABM11-132-24.000MHZ-T3](#) [ABM3B1-25.000MHZ-D2Y-T](#) [SPT2A-.032768B](#) [SPT2A.032768G](#) [SSPT7F-9PF20-R](#) [FX325BS-38.88EEM1201](#) [LFXTAL065253Cutt](#) [LFXTAL066431Cutt](#) [XT9S20ANA14M7456](#) [XT9SNLANA16M](#) [646G-24-2](#) [7A-24.576MBBK-T](#) [7B-30.000MBBK-T](#) [7A-14.31818MBBK-T](#) [6504-202-1501](#) [6526-202-1501](#) [ABLS-12.000MHZ-B2Y-T](#) [ABLS-10.000MHZ-D3W-T](#) [7A-10.000MBBK-T](#) [SG636PCE-20.000MC](#) [3404](#) [E1SAA18-25.000M TR](#) [CM315D32768EZFT](#) [C1E-24.000-7-2020-R](#) [C1E-19.200-12-1530-X-R](#) [C1E-16.000-12-1530-X-R](#) [FL5000014](#) [EUCA18-3.1872M](#) [FX0800015](#) [425F35E027M0000](#)