

DIN-Signal C096MS-3,0C1-1-clip



Image is for illustration purposes only. Please refer to product description.

Part number	09 03 396 2921
Specification	DIN-Signal C096MS-3,0C1-1-clip
HARTING eCatalogue	https://b2b.harting.com/09033962921

Identification

Category	Connectors
Series	DIN 41612
Identification	Type C
Element	Male connector
Description of the contact	Angled
Features	lead-free

Version

Termination method	Wave soldering termination
Connection type	Motherboard to daughtercard
	Extender card
	PCB to cable
Number of contacts	96
Contact configuration	Rows a, b and c, positions 1, 2, ... , 31, 32
Coding	Coding with loss of contacts
PCB fixing	With fixing flange
	With snap-in clip

Technical characteristics

Contact rows	3
Contact spacing (termination side)	2.54 mm
Contact spacing (mating side)	2.54 mm
Rated current	2 A
Rated current	Rated current measured at 20 °C, see derating curve for details



Pushing Performance

Technical characteristics

Clearance distance	≥1.2 mm
Creepage distance	≥1.2 mm
Insulation resistance	>10 ¹² Ω
Contact resistance	≤20 mΩ
Limiting temperature	-55 ... +125 °C
Insertion and withdrawal force	≤90 N
Performance level	1 acc. to IEC 60603-2
Mating cycles	≥500
Test voltage U _{r.m.s.}	1 kV
Isolation group	IIIa (175 ≤ CTI < 400)
PCB thickness	1.6 mm ±0.2
Hot plugging	No

Material properties

Material (insert)	Thermoplastic resin, glass-fibre filled
Colour (insert)	RAL 7032 (pebble grey)
Material (contacts)	Copper alloy
Surface (contacts)	Noble metal over Ni Mating side Sn over Ni Termination side
Material flammability class acc. to UL 94	V-0
RoHS	compliant
ELV status	compliant
China RoHS	e
REACH Annex XVII substances	No
REACH ANNEX XIV substances	No
REACH SVHC substances	No
California Proposition 65 substances	Yes
California Proposition 65 substances	Nickel Lead Antimony trioxide

Specifications and approvals

Specifications	IEC 60603-2
----------------	-------------

Specifications and approvals

UL / CSA

UL 1977 ECBT2.E102079
 CSA-C22.2 No. 182.3 ECBT8.E102079

Railway classification

F4/I3 acc. to NFF 16-101/102

Commercial data

Packaging size

100

Net weight

14.45 g

Country of origin

Germany

European customs tariff number

85366990

eCl@ss

27460201 PCB connector (board connector)

Current carrying capacity

The current carrying capacity of the connectors is limited by the thermal load capability of the contact element material including the connections and the insulating parts. The derating curve is therefore valid for currents which flow constantly (non-intermittent) through each contact element of the connector evenly, without exceeding the allowed maximum temperature.

Measuring and testing techniques acc. to IEC 60512-5-2

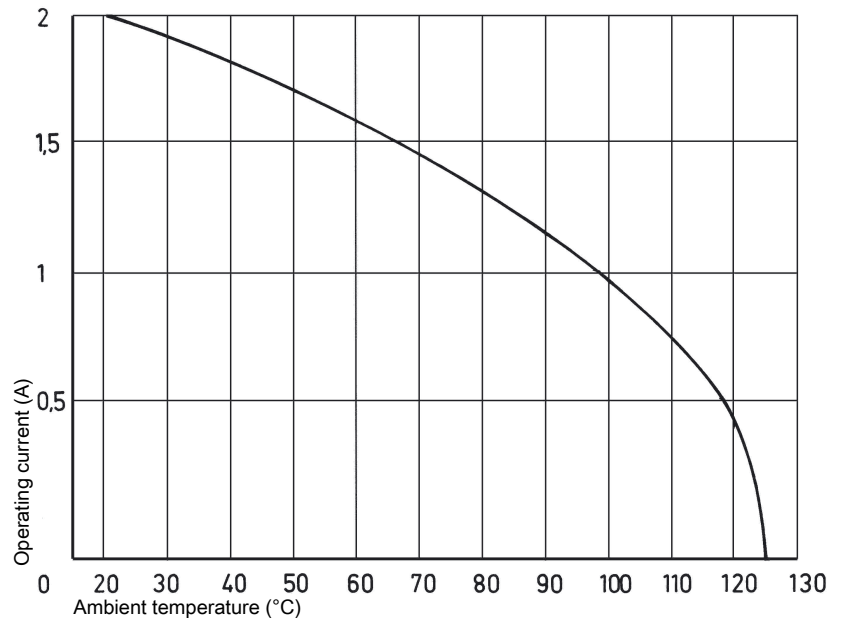

Cross section of solder termination

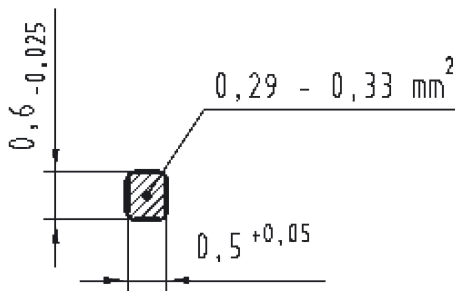

Soldering instructions

The connectors should be protected when being soldered. Otherwise, they might become contaminated as a result of soldering operations or deformed as a result of overheating.

- 1) For prototypes and short runs protect the connectors with an industrial adhesive tape, e.g. Tesaband 4331 (www.tesa.de). Cover the underside of the connector moulding and the adjacent parts of the pcb as well as the open sides of the connector. This will prevent heat and gases of the soldering apparatus from damaging the connector. About 140 + 5 mm of the tape should suffice.
- 2) For large series a jig is recommended. Its protective cover with a fast action mechanical locking device shields the connectors from gas and heat generated by the soldering apparatus. As an additional protection a foil can be used for covering the parts that should not be soldered.
- 3) For prototypes and short runs the protection described under point 1) can be replaced by a solder protection cap. This cap can be ordered under the part no. 09 02 000 9935.

Mating conditions

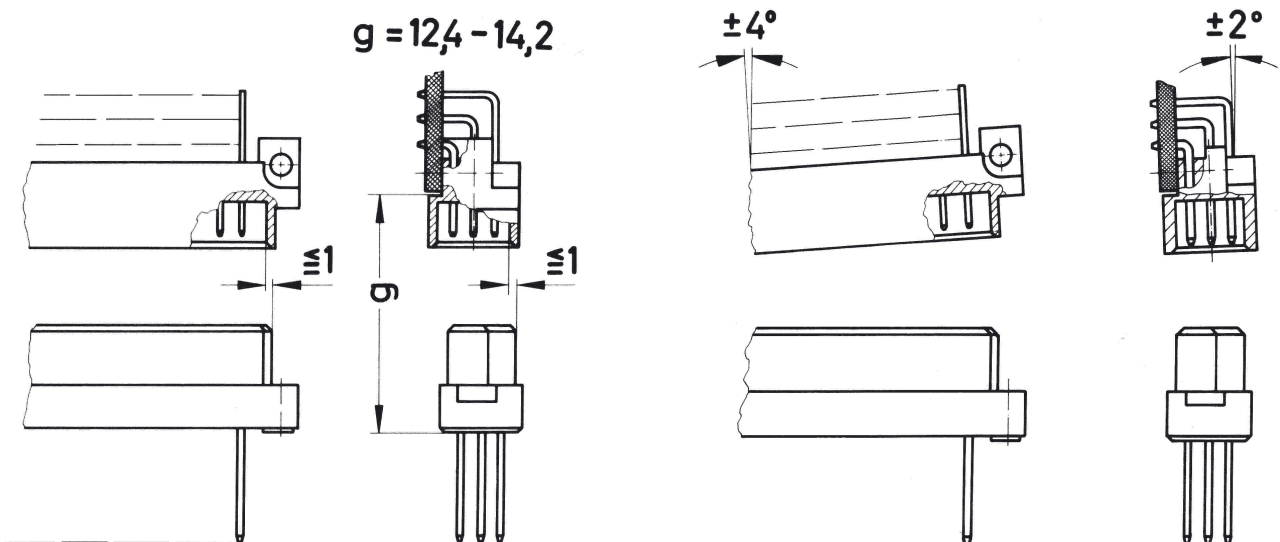

To ensure reliable connections and prevent unnecessary damage, please refer to the application data diagrams. These recommendations are set out in IEC 60603-2.

The connectors should not be coupled and decoupled under electrical load.

X-ON Electronics

Largest Supplier of Electrical and Electronic Components

Click to view similar products for [DIN 41612 Connectors](#) category:

Click to view products by [HARTING](#) manufacturer:

Other Similar products are found below :

[004.767](#) [608489050008049](#) [691327-1](#) [74670-0732](#) [74680-0340](#) [75880-0015](#) [76453-0014](#) [86093159ALF](#) [9732967801](#) [QLC260R](#)
[120X10019X](#) [120X10089X](#) [122A10249X](#) [122A10669X](#) [122A11089X](#) [122A13089X](#) [122A10089X](#) [122A10129X](#) [122A10349X](#)
[122A13359X](#) [1377391-4](#) [DIN-048CPC-SR1-MH](#) [1393583-2](#) [1393726-7](#) [140X10129X](#) [143-1913-000](#) [143-1908-000](#) [1484472-1](#) [2110070-1](#)
[2110070-2](#) [CBC20T00-008FDS5-0-1-002VR](#) [172699-5036](#) [2-1393557-4](#) [2-1437084-2](#) [CTJ720E01B-6141](#) [394506](#) [419-2080-402](#)
[V42254B2202C968](#) [419-2086-201](#) [419-2087-002](#) [448657-1](#) [448847-3](#) [5-1393755-9](#) [02990000004](#) [054302](#) [043556](#) [09062483201750](#)
[0850033067](#) [09031646555](#) [09061486901840](#)