

Alle Rechte vorbehalten/ All rights reserved

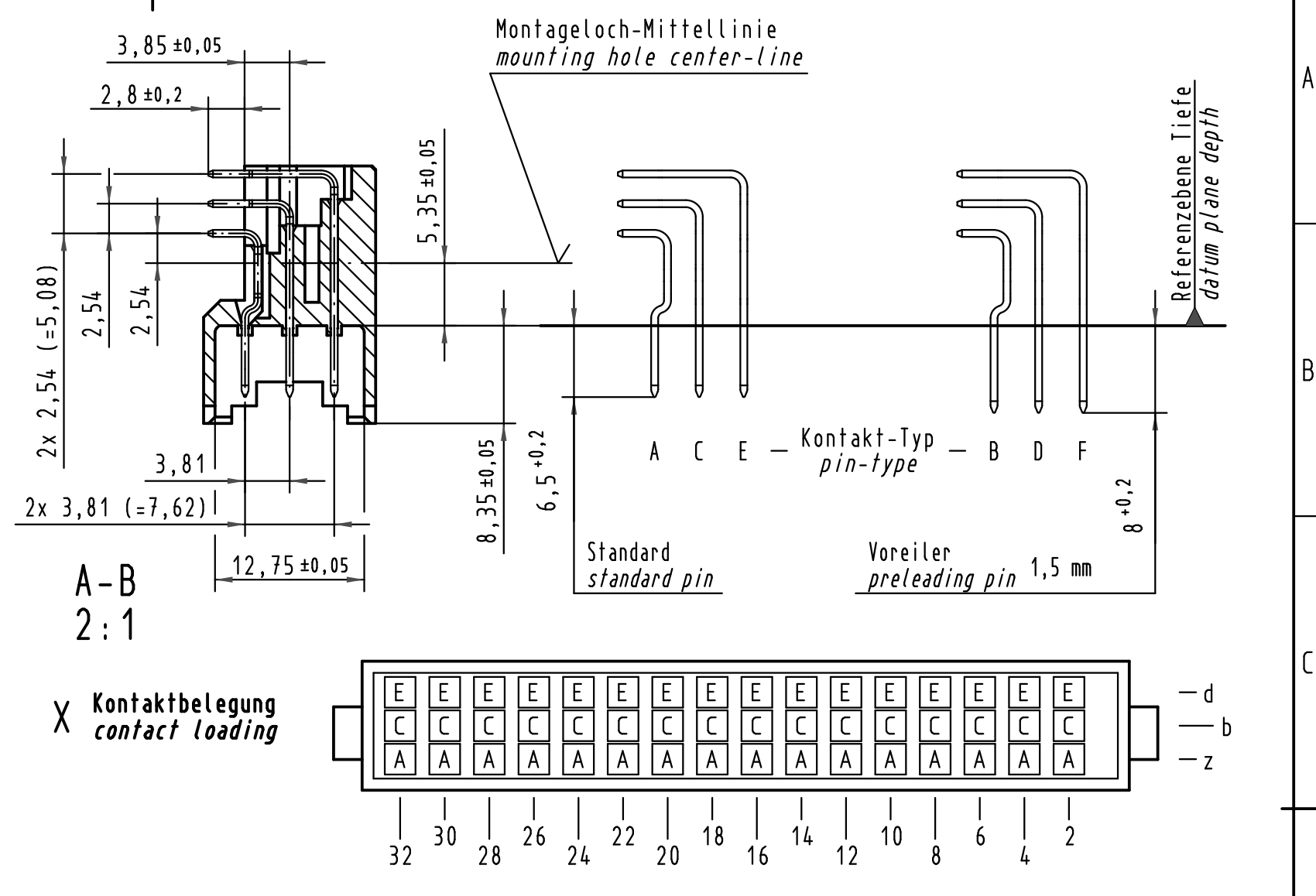

Z 10:1

Querschnitt der Lötanschlüsse:
cross-section of solder terminations:

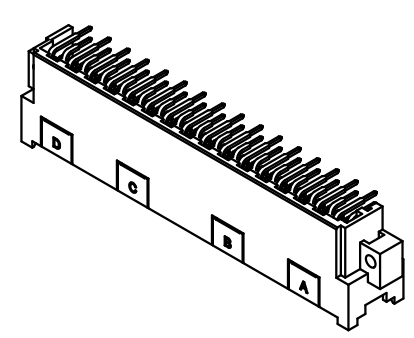
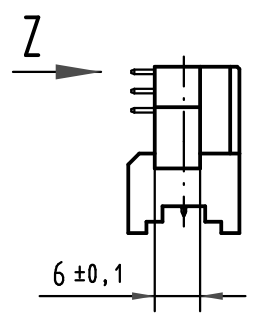
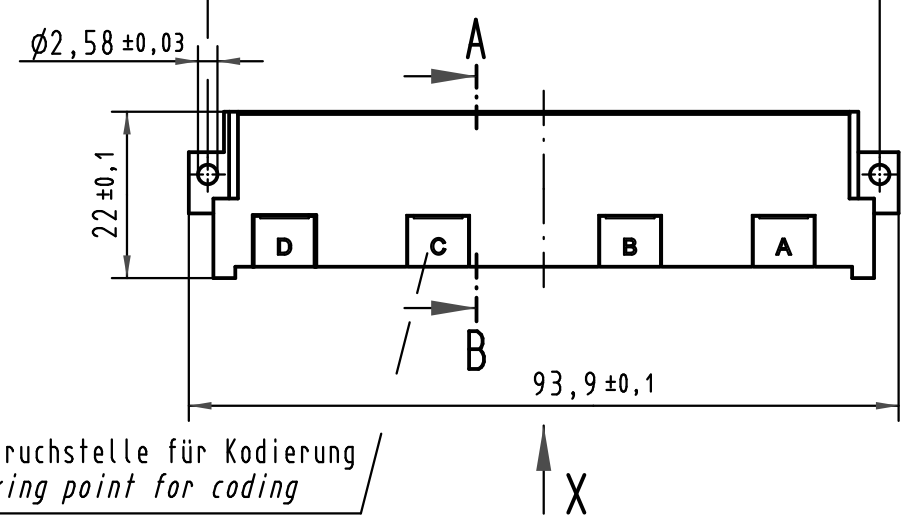
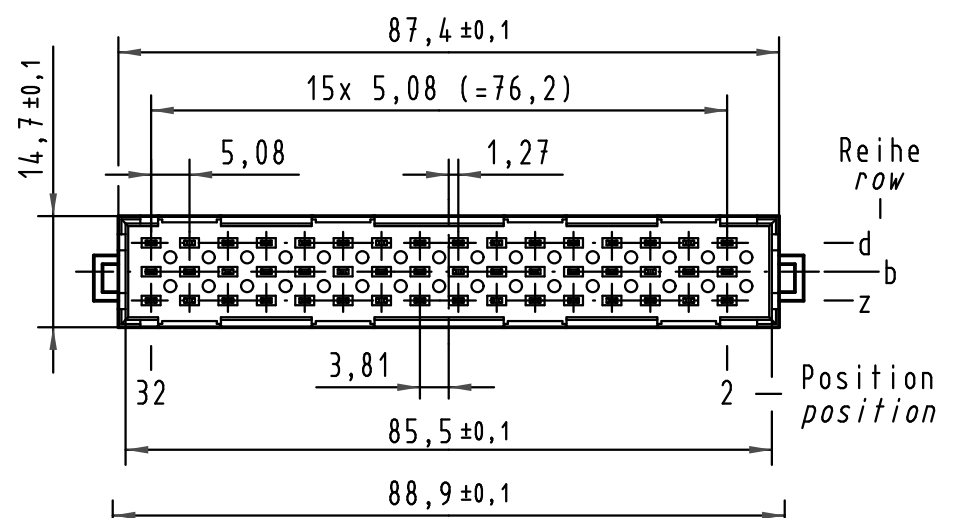
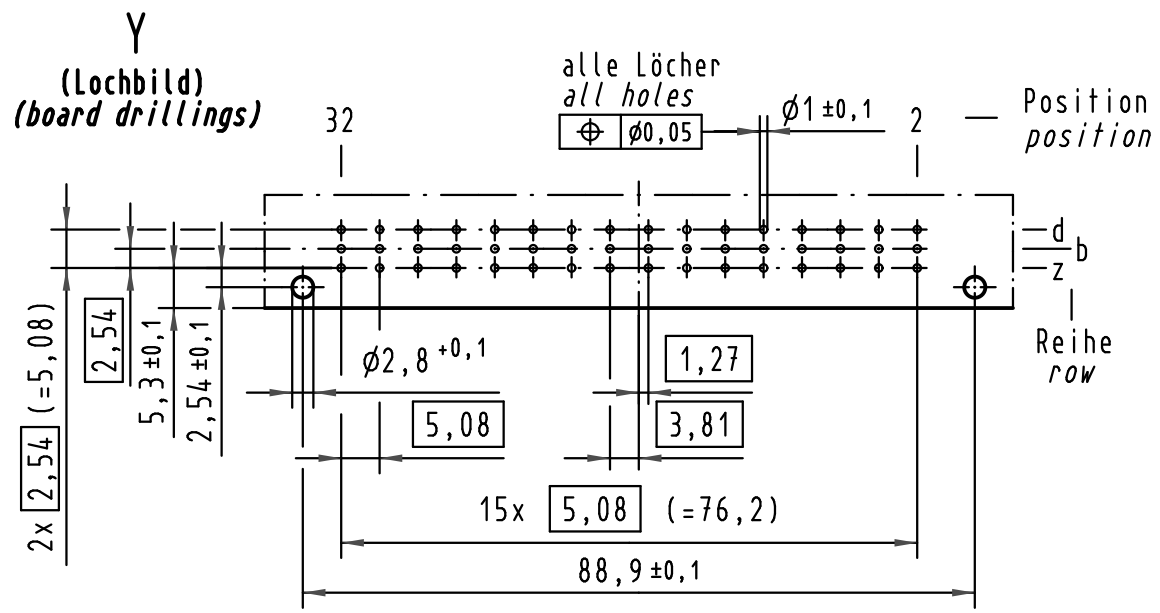
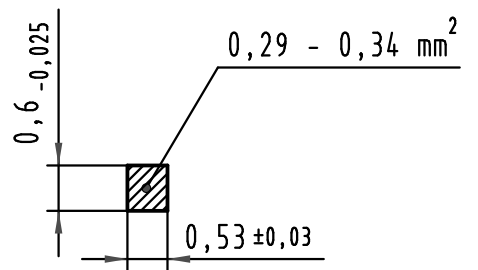

09 06 148 6901 840	2	Au flash over PdNi over Ni
09 06 148 2901 840	1	Au flash over PdNi over Ni
Bestell-Nr. part-no.	Anforderungsstufe nach IEC performance level acc. to IEC	Kontaktoberfläche contact plating

All Dimensions in mm Original Size DIN A 3			Techn. Character.			Nicht tolerierte Maßel Free size tolerances IEC 60603-2		
35260	08.09.08	Hage.						
33192								
Mod.	Dat.	Name	HARTING Electronics GmbH & Co. KG D-32339 ESPELKAMP			Bauform / type F Messerleiste Einlöt gewinkelt 2,54 48 pol. male connector solder angled 2,54 48 pol.		
			HARTING			TB 09 06 148 x901 840 Blatt/ page		
						Sub.		

X-ON Electronics

Largest Supplier of Electrical and Electronic Components

Click to view similar products for [DIN 41612 Connectors](#) category:

Click to view products by [HARTING](#) manufacturer:

Other Similar products are found below :

[004.767](#) [608489050008049](#) [691327-1](#) [74670-0732](#) [74680-0340](#) [75880-0015](#) [76453-0014](#) [86093159ALF](#) [9732967801](#) [QLC260R](#)
[120X10019X](#) [120X10089X](#) [122A10249X](#) [122A10669X](#) [122A11089X](#) [122A13089X](#) [122A10089X](#) [122A10129X](#) [122A10349X](#)
[122A13359X](#) [1377391-4](#) [DIN-048CPC-SR1-MH](#) [1393583-2](#) [1393726-7](#) [140X10129X](#) [143-1913-000](#) [143-1908-000](#) [1484472-1](#) [2110070-1](#)
[2110070-2](#) [CBC20T00-008FDS5-0-1-002VR](#) [172699-5036](#) [2-1393557-4](#) [2-1437084-2](#) [CTJ720E01B-6141](#) [394506](#) [419-2080-402](#)
[V42254B2202C968](#) [419-2086-201](#) [419-2087-002](#) [448657-1](#) [448847-3](#) [5-1393755-9](#) [02990000004](#) [054302](#) [043556](#) [09062483201750](#)
[0850033067](#) [09031646555](#) [09061486901840](#)