

Loading plan

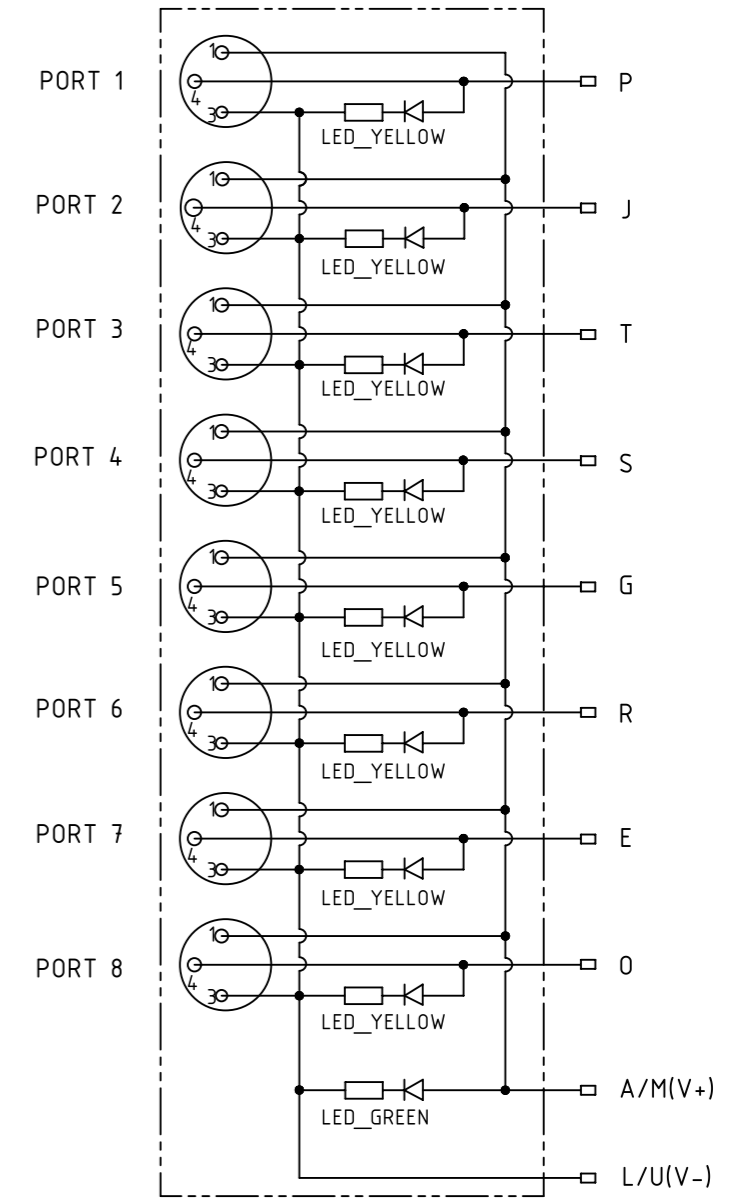

- Protection level: IP67
- Temperature range: -30°C ... +80°C

All Dimensions in mm		Tech. Character.		Free size tol.		According to production drawing	
All rights reserved Department HCS - RO		Created by MUNTEANV Muntean	Inspected by COSTEA Costea	Standardisation MUNTEANV Muntean	Date 2019-03-01	State Final Release	
HARTING Customised Solutions D-32339 Espelkamp		Title har-SAB M8/8/3p M16/14p				Doc-Key / ECM-Nr. 100689724/UGD/000/C 50000014.8064	
		Type TB	Number 090700420100			Rev. C	Page 1/1

X-ON Electronics

Largest Supplier of Electrical and Electronic Components

Click to view similar products for [Circular Metric Connectors](#) category:

Click to view products by [HARTING](#) manufacturer:

Other Similar products are found below :

[600X518037X](#) [6STD15PCR99B70A](#) [8R4000A16M020](#) [8R5000A16M005](#) [1200910002](#) [1203580030](#) [1200910008](#) [1200910011](#) [1300140094](#)
[130203-0054](#) [1300140026](#) [1300150099](#) [1-3637-600-5205](#) [1612618](#) [21036836414](#) [8R4006A16M010](#) [1R3006A20M005](#) [41-40011](#) [42-00006](#)
[42-01015](#) [4-22279-4](#) [4-22281-1](#) [4-22284-9](#) [43-00113](#) [43-01203](#) [41-40013](#) [42-00008](#) [43-00343](#) [43-01026](#) [43-01162](#) [43-01173](#) [43-10000](#)
[XS3P-M421-2](#) [600X518050X](#) [8R5006A16M020](#) [8R5006A16M005](#) [8R4000A16M010](#) [6-22279-3](#) [1605332](#) [N03FA03144](#) [1300140077](#) [43-](#)
[16213](#) [43-01338](#) [XS2RD4265](#) [XS2R-D426-1](#) [XS8A-0441](#) [859RD04-103R004](#) [860RD04-113R004](#) [860RD04-213R004](#) [1-213245-2](#)