

## SEK-18 SV MA STD STRWW 50P PL2

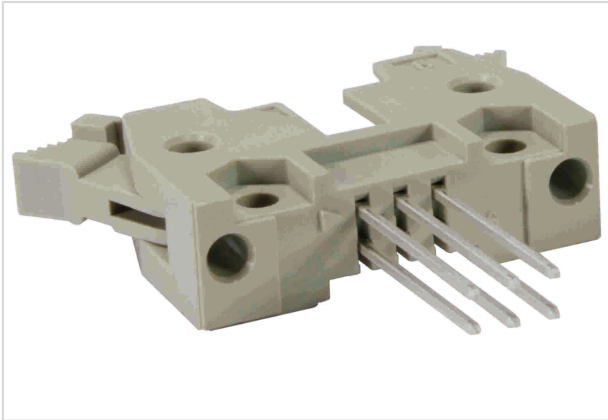

Image is for illustration purposes only. Please refer to product description.

Part number	09 18 550 6927
Specification	SEK-18 SV MA STD STRWW 50P PL2
HARTING eCatalogue	<a href="https://b2b.harting.com/09185506927">https://b2b.harting.com/09185506927</a>

### Identification

Category	Connectors
Series	SEK Standard
Element	Male connector
Description of the contact	Straight

### Version

Termination method	Wrap termination
Connection type	PCB to cable
Number of contacts	50
Termination length	15 mm

### Technical characteristics

Dimensions wire wrap post	0.6 x 0.6 mm
Contact rows	2
Contact spacing (termination side)	2.54 mm
Rated current	1 A
Insulation resistance	$>10^9 \Omega$
Contact resistance	$\leq 20 \text{ m}\Omega$
Limiting temperature	-55 ... +125 °C
Insertion and withdrawal force	$\leq 100 \text{ N}$
Performance level	2 acc. to IEC 60603-13
Mating cycles	$\geq 250$



Pushing Performance

## Technical characteristics

Test voltage $U_{r.m.s.}$	1 kV
Isolation group	IIIa ( $175 \leq CTI < 400$ )

## Material properties

Material (insert)	Thermoplastic resin (PBT)
Colour (insert)	Grey
Material (contacts)	Copper alloy
Surface (contacts)	Noble metal over Ni Mating side Sn over Ni Termination side
Material flammability class acc. to UL 94	V-0
RoHS	compliant
ELV status	compliant
China RoHS	e
REACH Annex XVII substances	No
REACH ANNEX XIV substances	No
REACH SVHC substances	No
California Proposition 65 substances	Yes
California Proposition 65 substances	Nickel Lead Antimony trioxide

## Specifications and approvals

Specifications	IEC 60603-13
UL / CSA	UL 1977 ECBT2.E102079 CSA-C22.2 No. 182.3 ECBT8.E102079
Railway classification	F3/I3

## Commercial data

Packaging size	50
Net weight	12.26 g
Country of origin	Romania
European customs tariff number	85366990
eCl@ss	27460201 PCB connector (board connector)

### Current carrying capacity

The current carrying capacity of the connectors is limited by the thermal load capability of the contact element material including the connections and the insulating parts. The derating curve is therefore valid for currents which flow constantly (non-intermittent) through each contact element of the connector evenly, without exceeding the allowed maximum temperature.

Measuring and testing techniques acc. to IEC 60512-5-2



- ① Temperature raise
- ② Derating curve
- ③ Derating curve 80%

### Cross section of solder termination

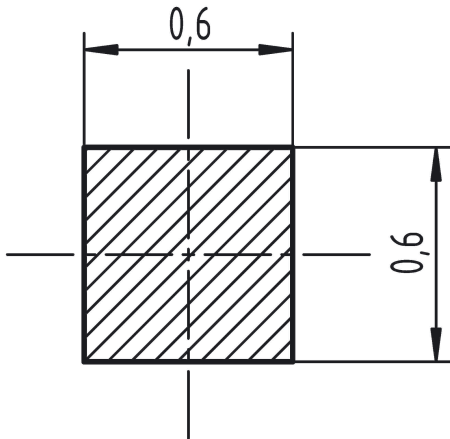

## X-ON Electronics

Largest Supplier of Electrical and Electronic Components

*Click to view similar products for [Headers & Wire Housings](#) category:*

*Click to view products by [HARTING](#) manufacturer:*

Other Similar products are found below :

[892-18-020-10-001101](#) [58102-G61-06LF](#) [582553-1](#) [0009485154](#) [009176003701906](#) [0050291907](#) [LY20-4P-DT1-P1E-BR](#) [02.125.8002.8](#)  
[609-3404](#) [61062-3](#) [622-0430](#) [622-3653LF](#) [63453-116](#) [636-1030](#) [636-1427](#) [636-3427](#) [636-4007](#) [641938-9](#) [641991-4](#) [644827-2](#) [65817-010LF](#)  
[65817-015LF](#) [65863-015LF](#) [66207-023LF](#) [67095-007LF](#) [67601157](#) [68648-049](#) [70.362.1628.0](#) [70-4210](#) [70-4226B](#) [70-4853B](#) [707-5020](#) [707-](#)  
[5028](#) [71.350.2428.0](#) [71918-208LF](#) [71961-016LF](#) [733-134](#) [733-162](#) [754199-000](#) [760-3052](#) [787-8014-00](#) [79531-3000](#) [FCN-360C032-B](#) [FCN-](#)  
[367T-T012/H](#) [FCN-723D010/2](#) [80.063.4001.1](#) [800-90-001-10-001000](#) [800-90-010-10-002000](#) [801-43-002-10-013000](#) [801-43-006-10-002000](#)