

X
(Lochbild)
(board drillings)

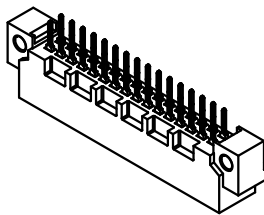

Montageloch-Mittellinie
mounting hole center-line

A-B
2:1

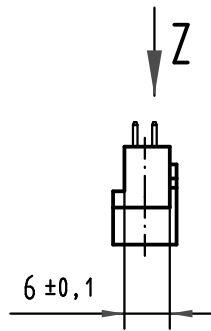
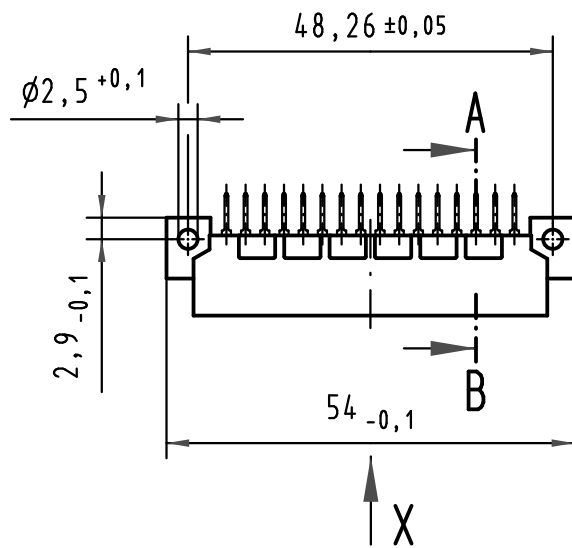
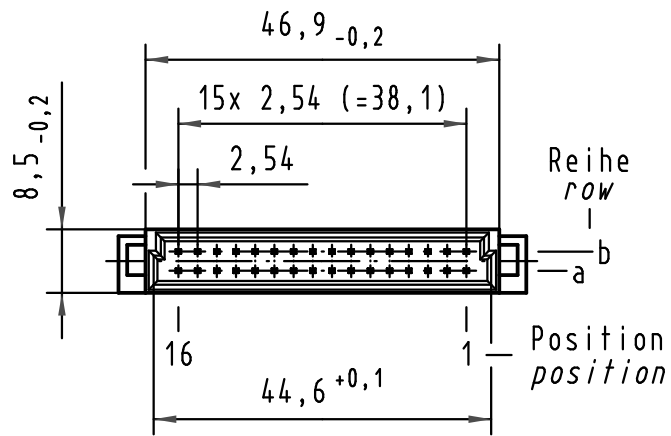
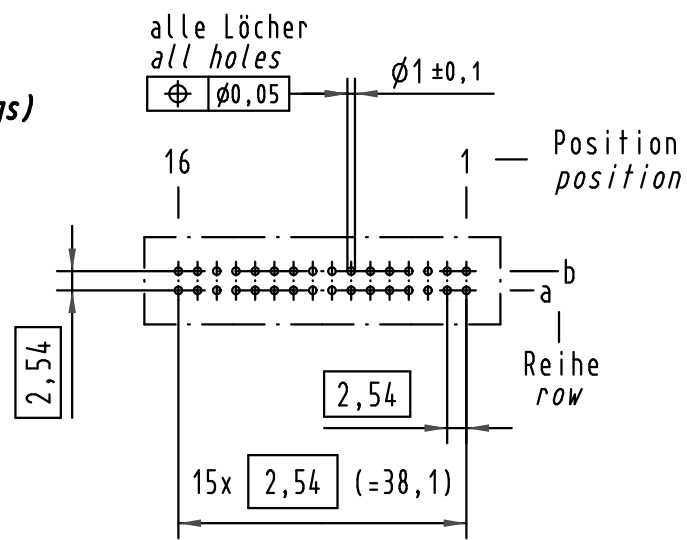
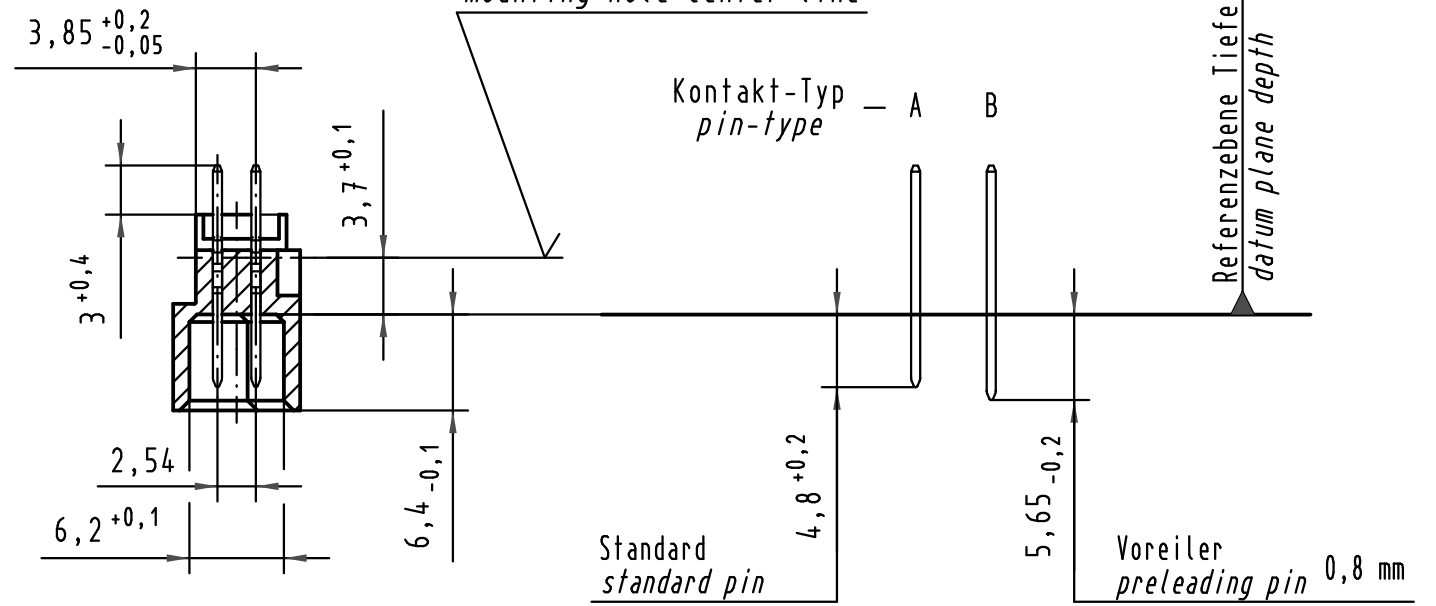

X Kontaktbelegung
contact loading

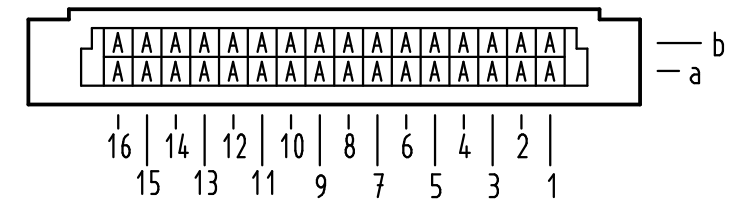

09 22 132 7922	3	Au flash over PdNi over Ni
09 22 132 6922	2	Au flash over PdNi over Ni
09 22 132 2922	1	Au flash over PdNi over Ni
Bestell-Nr. part-no.	Anforderungsstufe nach IEC performance level acc. to IEC	Kontaktoberfläche contact plating

Z
10:1

Querschnitt der
Lötanschlüsse:
cross-section of
solder terminations:

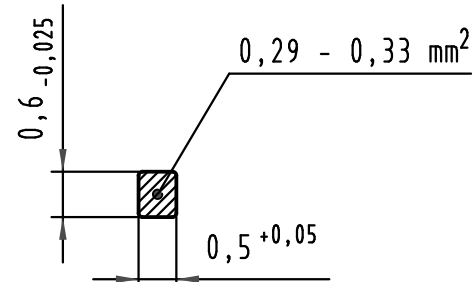

All Dimensions in mm Original Size DIN A 3		
Mod.	Dat.	Name
35345	23.10.08	Hage.
34650	12.12.07	Hage.
28429		

Techn. Character.		
	Dat.	Name
	08.08.00	Rie.
	08.08.00	Pa.
Stand.		
Maßstab/Scale		
1:1		
2:1		
10:1		

Nicht tolerierte Maße/Free size tolerances
IEC 60603-2
Bauform 2B Messerleiste
Einlöt, 32 pol.
type 2B male connector
solder, 32 pol.

HARTING Electronics GmbH & Co. KG
D-32339 ESPELKAMP



TB 09 22 132 x922

Blatt/page

Sub.

X-ON Electronics

Largest Supplier of Electrical and Electronic Components

Click to view similar products for [DIN 41612 Connectors](#) category:

Click to view products by [HARTING](#) manufacturer:

Other Similar products are found below :

[09231126901](#) [PCN10F-24P-2.54DS\(72\)](#) [004.767](#) [02221602702](#) [024069](#) [602427301412000](#) [013275](#) [691327-1](#) [74670-0732](#) [74680-0340](#)
[75880-0015](#) [76453-0014](#) [86093159ALF](#) [923454](#) [QLC260R](#) [120X10099X](#) [120X10019X](#) [120X10089X](#) [120X10129X](#) [121A10039X](#)
[121A10309X](#) [122A10019X](#) [122A10029X](#) [122A10249X](#) [122A10669X](#) [122A11089X](#) [122A13089X](#) [122A10089X](#) [122A10129X](#)
[122A10349X](#) [122A13359X](#) [1377391-4](#) [DIN-048CPC-SR1-MH](#) [1393583-2](#) [1393726-7](#) [140X10059X](#) [140X10129X](#) [143-1913-000](#) [143-1908-](#)
[000](#) [1484472-1](#) [173052](#) [2110070-1](#) [2110070-2](#) [CBC20T00-008FDS5-0-1-002VR](#) [983-0SE12-12P6](#) [17041102202](#) [172699-5036](#) [173051](#) [20](#)
[8457096](#) [010](#) [025](#) [208458096005133](#)