

Alle Rechte vorbehalten/ All rights reserved

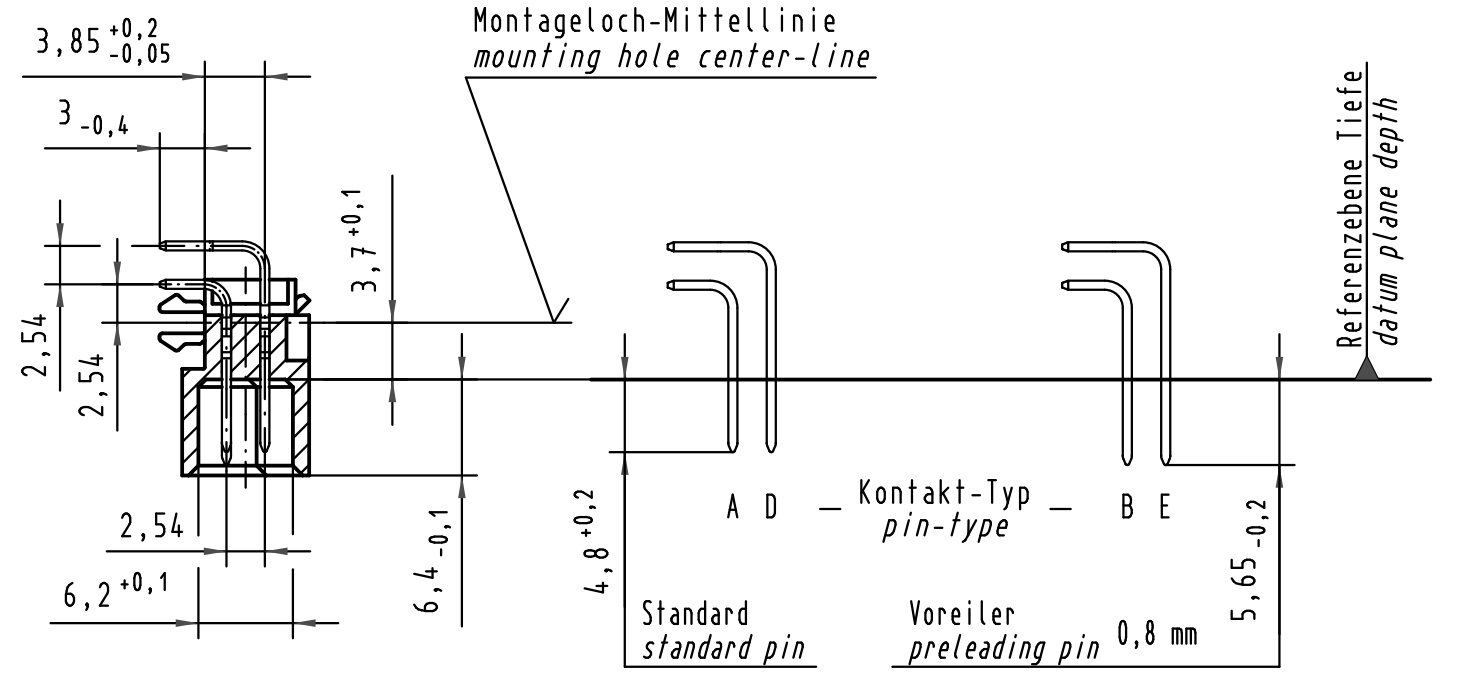

X Kontaktbelegung contact loading

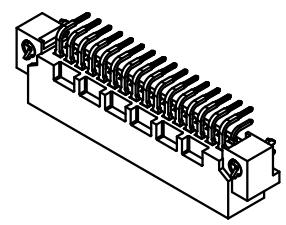
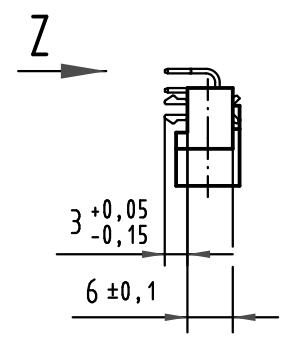
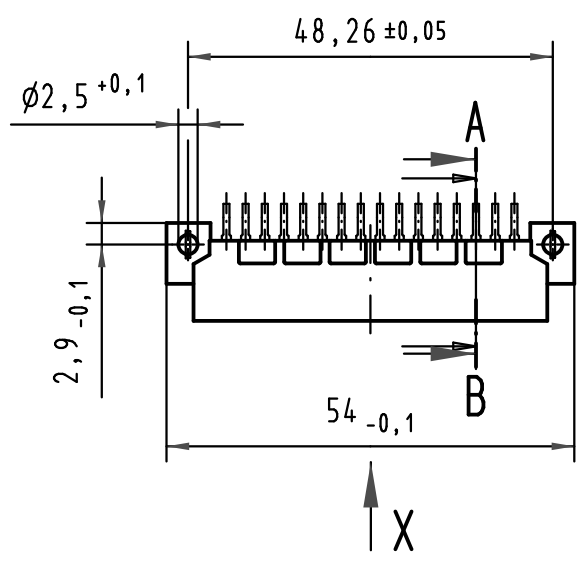
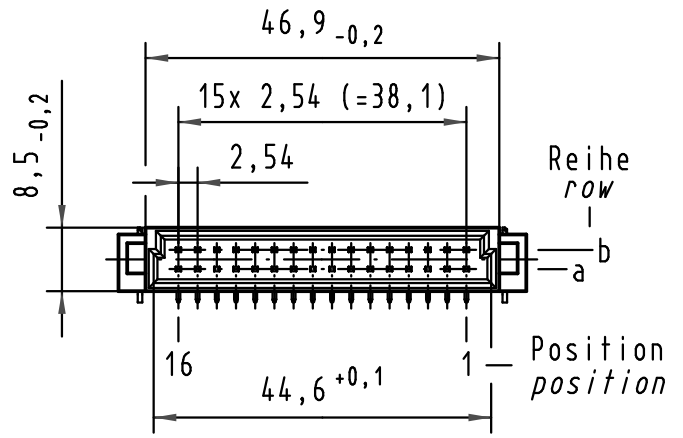
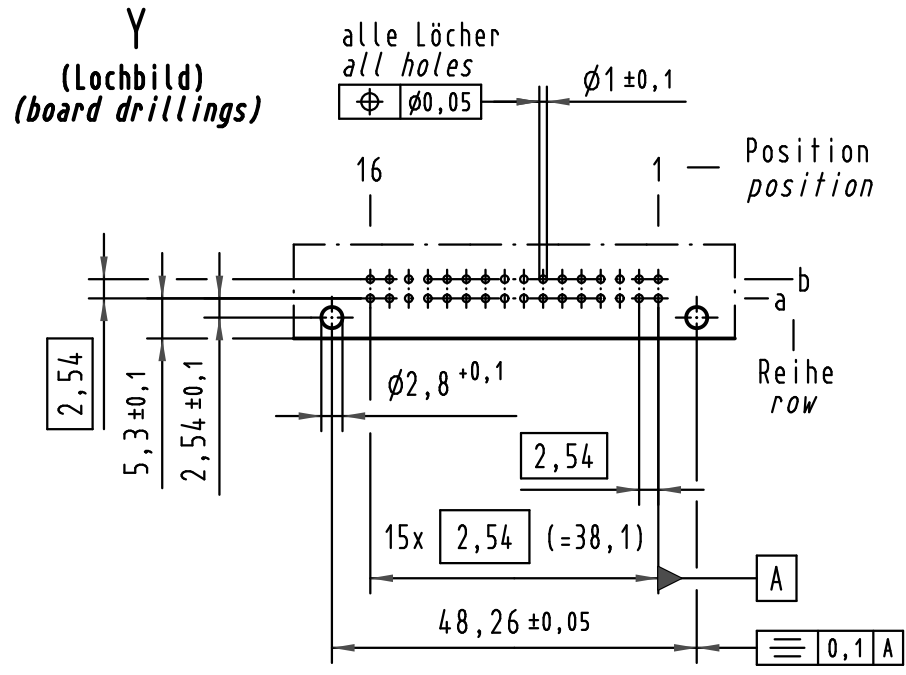
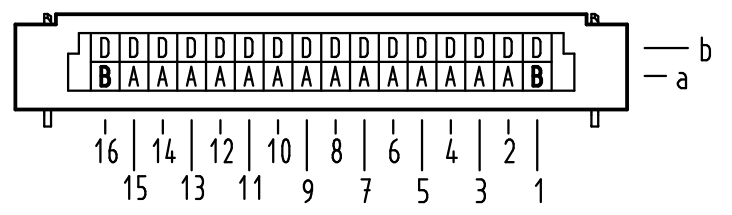

09 22 332 6951	2	Au flash over PdNi over Ni
Bestell-Nr. part-no.	Anforderungsstufe nach IEC performance level acc. to IEC	Kontaktoberfläche contact plating

Z 10:1

Querschnitt der Lötanschlüsse:
cross-section of solder terminations:

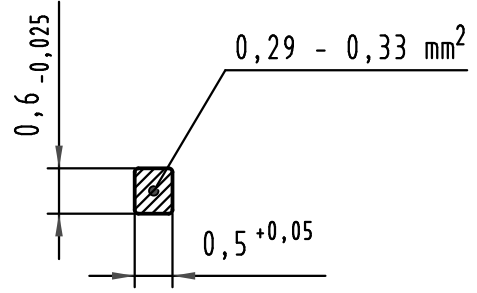

All Dimensions in mm Original Size DIN A 3		
Mod.	Dat.	Name
35495		

Techn. Character.		
	Dat.	Name
	08.04.09	Hage.
	08.04.09	LehT
HARTING Electronics GmbH & Co. KG D-32339 ESPELKAMP		

Nicht tolerierte Maße/Free size tolerances IEC 60603-2	
Bauform 2B Messerleiste mit Clip Einlöt, 32 pol. type 2B male connector with clip solder, 32 pol.	
TB 09 22 332 x951	Blatt/page
Sub.	

X-ON Electronics

Largest Supplier of Electrical and Electronic Components

Click to view similar products for [DIN 41612 Connectors](#) category:

Click to view products by [HARTING](#) manufacturer:

Other Similar products are found below :

[09231126901](#) [PCN10F-24P-2.54DS\(72\)](#) [004.767](#) [02221602702](#) [024069](#) [602427301412000](#) [013275](#) [691327-1](#) [74670-0732](#) [74680-0340](#)
[75880-0015](#) [76453-0014](#) [86093159ALF](#) [923454](#) [QLC260R](#) [120X10099X](#) [120X10019X](#) [120X10089X](#) [120X10129X](#) [121A10039X](#)
[121A10309X](#) [122A10019X](#) [122A10029X](#) [122A10249X](#) [122A10669X](#) [122A11089X](#) [122A13089X](#) [121B10409X](#) [122A10089X](#)
[122A10129X](#) [122A10349X](#) [122A13359X](#) [1377391-4](#) [DIN-048CPC-SR1-MH](#) [1393583-2](#) [1393726-7](#) [140X10059X](#) [140X10129X](#) [143-1913-](#)
[000](#) [143-1908-000](#) [1484472-1](#) [173052](#) [2110070-1](#) [2110070-2](#) [CBC20T00-008FDS5-0-1-002VR](#) [983-0SE12-12P6](#) [17041102202](#) [172699-](#)
[5036](#) [173051](#) [20](#) [8457096](#) [010](#) [025](#)