

Adapter Han 16B - 2x D-Sub 50

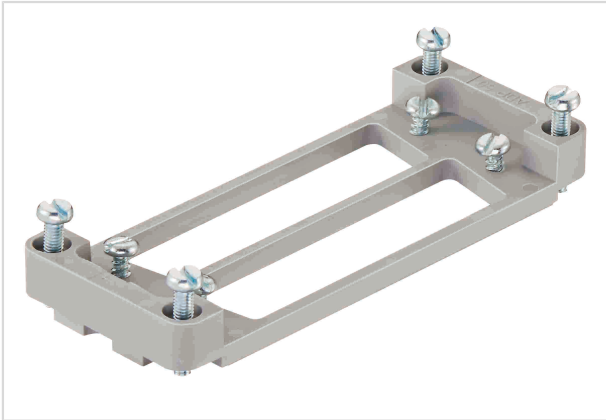

Image is for illustration purposes only. Please refer to product description.

Part number	09 30 000 9974
Specification	Adapter Han 16B - 2x D-Sub 50
HARTING eCatalogue	https://b2b.harting.com/09300009974

Identification

Category	Accessories
Type of accessory	Adapter plate
Description of the accessory	for 2x D-Sub
Adapter for	D-Sub 5

Version

Size	16 B
Pack contents	1 adapter 4 fixing screws for adapter 4 fixing screws for D-Sub connector

Material properties

Material (accessories)	Thermoplastic
RoHS	compliant
ELV status	compliant
China RoHS	e
REACH Annex XVII substances	No
REACH ANNEX XIV substances	No
REACH SVHC substances	No

Commercial data

Packaging size	2
Net weight	0.01 g
Country of origin	Germany



Pushing Performance

Commercial data

European customs tariff number 85389099

eCl@ss 27440201 Adapter plate industrial connectors

X-ON Electronics

Largest Supplier of Electrical and Electronic Components

Click to view similar products for [D-Sub Tools & Hardware](#) category:

Click to view products by [HARTING](#) manufacturer:

Other Similar products are found below :

[000-01-09-132](#) [000-01-21-132](#) [000-01-31-162](#) [572019-00105-70](#) [000-01-37-162](#) [621-250-113-115](#) [D110550-2](#) [D20418-137](#) [780-518-50SG6-WS](#) [86552009](#) [86553115TLF](#) [86553117TLF](#) [1230032-1](#) [1-5021101-2](#) [1589283-4](#) [160-000-005R031](#) [16-000230](#) [160-025-004R031](#) [160-020-209R000](#) [160X10909X](#) [164C03939A](#) [177-505-A-2-2](#) [1-966830-8](#) [21018-6](#) [2-1393560-9](#) [JS-1000](#) [L17D204182M3E](#) [L17D53018](#) [300X10779X](#) [160X10189X](#) [160X10419X](#) [162-000-050R000](#) [21018-5](#) [212561-3](#) [248C21550X](#) [CF15P](#) [D110277](#) [D20418-135](#) [500-008NF1K-01](#) [500-008NF3R3KS-01](#) [500-017M09FN](#) [500-017M15MHN](#) [500-024M1](#) [500-068M3](#) [5-1393561-5](#) [C115373-0001](#) [C115373-0002](#) [3342-4-KIT](#) [K1003](#) [L17D4M68711](#)