

# 04. Industrial Connector Han®

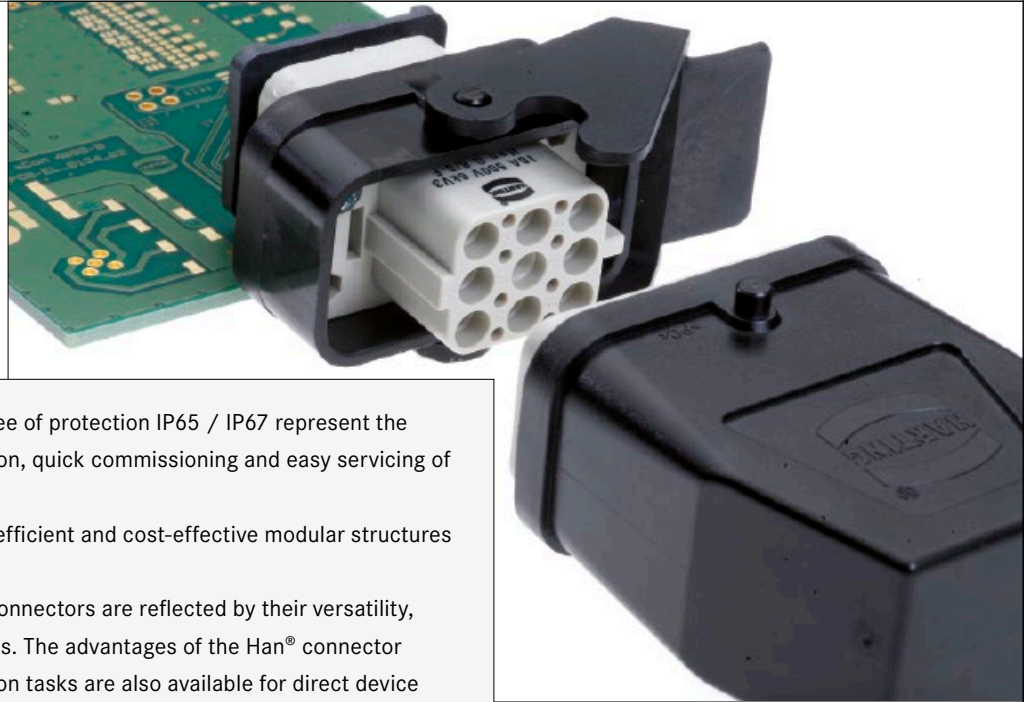

Han® industrial connectors with degree of protection IP65 / IP67 represent the worldwide standard for safe installation, quick commissioning and easy servicing of machines and plants.

The use of Han® connectors enables efficient and cost-effective modular structures of machines and plants.

The outstanding properties of Han® connectors are reflected by their versatility, application bandwidth and ruggedness. The advantages of the Han® connector family that users know from installation tasks are also available for direct device connections. The Han® connectors support the installation of automation systems in control cabinets and of IP65 / IP67 distributed devices using identical connectors. Key user benefits: Investment and operational security.

### Application profile:

CONNECTION TYPE		ENVIRONMENT		APPLICATION							
Board to Board	Cable/Wire to Board	IP20	IP65 / IP67	Data	Signal	Power	high performance				
							Data transfer rate	Shielding	Number of contacts, contact density	Voltage, working current	
Cable termination			PCB termination			Application standard					
<i>Han-Quick Lock®</i> <i>IDC</i> <i>Crimp</i>			<i>THT</i> <i>SMC</i> <i>SMT</i>			 <b>ECOFAST</b>					
<i>Screw</i> <i>Cage clamp</i> <i>Axial screw</i>			<i>Press-in</i>			Housing integration					
						<i>separate housing</i> <i>integrated housing</i>					

## Contents

	Page
Han® 3 A RJ45 .....	<b>04.04</b>
Han® 3 A 2 x LC duplex .....	<b>04.10</b>
Han® 3 A RJ45 Hybrid (3 x Power) .....	<b>04.11</b>
Han® 3 A LC duplex Hybrid (3 x Power) .....	<b>04.13</b>
Han® 3 A RJ45 Hybrid (4 x Power) .....	<b>04.15</b>
Han-Brid® .....	<b>04.20</b>
Han® Q 5/0 with pcb adapter .....	<b>04.30</b>
Han® Q 7/0 with pcb adapter .....	<b>04.32</b>
Han® Q 4/2 with pcb adapter .....	<b>04.36</b>
Han® Q 8/0 with pcb adapter .....	<b>04.38</b>
Han DD® with pcb adapter .....	<b>04.44</b>
Han E® with pcb adapter .....	<b>04.46</b>
Han-Modular® with pcb adapter .....	<b>04.48</b>

Han® connectors with degree of protection IP65 / IP67 are established as the worldwide standard for industrial connectors. This standard connector can also be used directly as appliance connector.

The rugged housings are equipped with secure interlock mechanisms that protect the contact inserts from external negative influences such as dust, dampness and mechanical stress. On the appliance side, the connector contacts are routed in the bulkhead mount module, soldered directly onto the PCB and are aligned precisely to the bulkhead frame. This results in appliance connections that are resistant to any environmental stress.

The Han® appliance connectors offer comprehensive solutions based on connector inserts for data, signal and power lines up to 32 A per contact. The Han® 3 A housing can be equipped for

communication applications with copper-bound RJ45 modules, 4-pole (Cat. 5) and 8-pole (Cat. 6) and optical LC modules. The power contact inserts are available for the Han® 3 A, Han® Compact and Han® B housing variants. The cables can be wired to the contact inserts by way of crimp, screw or cage clamp terminals, or using the patented Quick-Lock® quick connection technology for on-site assembly.

HARTING highlights its Han® 3 A appliance connector series with versatile hybrid contact inserts for wiring data and power lines using a single connector and cable. This functionality results in a reduction of insertion points and cabling by more than 50%.

Han® connectors with high degree of protection can be used for wiring appliances, terminal boxes and control cabinets.



## Han® APPLIANCE CONNECTORS:

The PCB-Adapter of HARTING can be used to convert Han® industrial connectors into fully-fledged PCB connectors. The modular PCB adapters enable the implementation of various Han® contact inserts.

The PCB Adapter concept:

- The PCB adapter is processed as component in a standard soldering process and is a fixed part of the PCB.
- The contact insert of the Han® industrial connector is simply plugged in after the soldering process has been completed.
- The bulkhead mount housing with the bracket interlock is mounted to the appliance housing.

This modularity guarantees the availability of a wide range of contact inserts and connector housings for the assembly of a multitude of rugged IP65 / IP67 appliance connectors for data, signal and power lines.

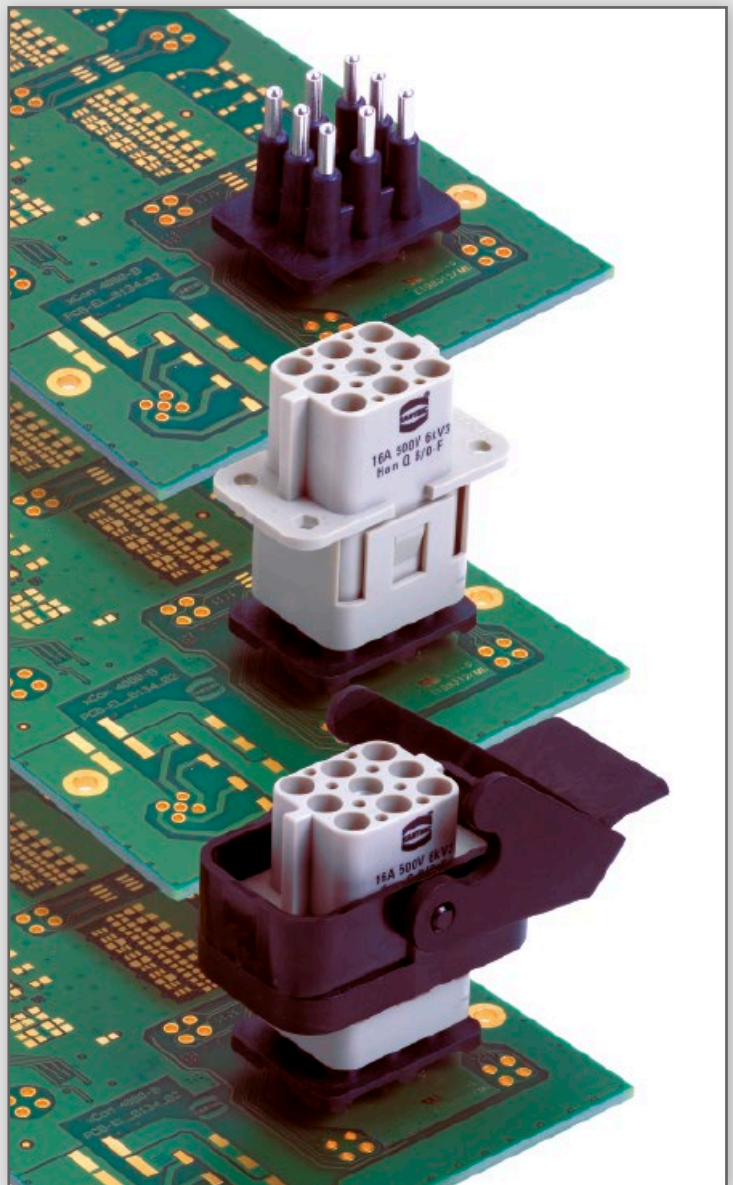

## SCALABLE HYBRID APPLIANCE CONNECTION USING Han® CONNECTORS:

The hybrid appliance connector series enable the cost-effective combination of Fieldbus/Ethernet communication and power supply lines in a single cable and connector.

The contact insert combination for communication and for the power supply to the appliance is soldered directly to the PCB. The bulkhead mount housing can be adapted directly to the housing shape, or be mounted as separate unit to the appliance housing. HARTING offers cable solutions for smaller batches which can be used to connect the contact insert to the PCB.

Key user benefits: A tailored appliance connection is always available for small- and large-scale appliance series.





Han® 3 A RJ45 device side

## Advantages

- Simple mounting
- RJ45 plug-compatible
- Different versions cover all applications
- Coding (4 variants) possible

## Technical characteristics

Number of ports	2 / 1x Han® 3 A RJ45 (IP65 / IP67)
Copper / termination	1x RJ45 (IP20)
Transmission performance	Category 5 / Class D up to 100 MHz acc. to ISO/IEC 11801:2002, EN 50173-1
Transmission rate	10/100/1000 Mbit/s
Shielding	fully shielded, 360° shielding contact
Mounting	screw-on type on steel plate walls
Degree of protection	IP65 / IP67
Mating cycles	min. 500
Temperature range	-40 °C ... +70 °C
Housing material	
Plastic version	Polycarbonate, black, UL 94 V0
Metal version	Zinc die-cast, powder coating, grey

Identification	Part number	Drawing	Dimensions in mm
<b>Housing bulkhead mounting</b>  Plastic version, black Metal version Standard Metal version M  with fixed cover and with seal Metal version Standard Metal version M	09 20 003 0327 09 20 003 0301 09 37 003 0301  09 20 003 0306 09 37 003 0306	<p>Dimensions valid for Metal version Standard</p>	
<b>Adapter</b> for fixing of RJ45 jack with fixing clip without fixing clip	09 45 515 0020 09 45 515 0022		
<b>RJ45 jacks Cat. 5</b>  Solder variant SMD, 90° angled Solder variant overmolded, 90° angled	09 45 551 1100 <sup>1)</sup> 09 45 551 1110 <sup>2)</sup>  09 45 551 1102 <sup>1)</sup>		

1) Packaging: Blister à 120 pieces

2) Packaging: Tape & Reel à 130 pieces



Han® 3 A RJ45-panel feed-throughs and couplings Cat. 5

Identification	Part number	Drawing	Dimensions in mm		
<b>Panel feed-through set, 8-poles</b>					
Plastic version, black	straight				
	angled			09 45 225 1108	
Metal version Standard, grey	straight			09 45 215 1100	
	straight, inner vertical jack			09 45 215 1101	
	angled			09 45 215 1108	
Metal version Standard, grey with self-closing protective cap	straight			09 45 215 1103	
Metal version M, black	straight			09 45 215 1102	
	angled			09 45 215 1109	
Coding pin set for 4 different codings	09 45 820 0000			Dimensions valid for plastic version, straight	
<b>Double coupling, 8-poles incl. installation frame metal</b>					
Plastic version, black	09 45 225 1107		Dimensions valid for plastic version		
Metal version Standard, grey	09 45 215 1107				
Metal version M, black	09 45 215 1110				
Coding pin set for 4 different codings	09 45 820 0000				
<b>Protection cover for panel feed-through IP65 / IP67 with seal</b>					
Plastic version, black	09 20 003 5449		Dimensions valid for plastic version		
Metal version Standard, grey	09 20 003 5425				
Metal version M, black	09 37 003 5405				



Han® 3 A RJ45 10G Cat. 6 – panel feed-throughs

## Advantages

- Compact and robust design
- 360° shielding
- Easy mounting
- Transmission category 6, performance class E<sub>A</sub>, suitable for 1/10 Gigabit Ethernet
- RJ45 mating compatible
- Coding (4 variants) possible

## Technical characteristics

Number of ports	2 / 1x Han® 3 A RJ45 (IP65 / IP67) 1x RJ45 (IP20)
Transmission performance	Category 6 / class E <sub>A</sub> acc. to ISO/IEC 11801:2002, EN 50 173-1
Transmission rate	10/100 Mbit/s and 1/10 Gbit/s
Shielding	Fully shielded, 360° shielding contact
Mounting	Screwable to cover plates
Degree of protection	IP65 / IP67
Mating cycles	min. 500
Temperature range	-40 °C ... + 70 °C
Housing material	
Plastic version	Polycarbonate, black, UL 94 V0
Metal version	Zinc die-cast, powder-coated

Identification	Part number	Drawing	Dimensions in mm
<b>Panel feed-through set, 8-poles</b> Plastic version, black Metal version Standard, grey Metal version M, black  Metal version Standard, grey, with self-closing protective cap	09 45 225 1560 09 45 215 1560 09 45 215 1561  09 45 215 1562		
<b>Han® 3 A RJ45 10G insert Cat. 6</b> (for Han® 3 A housings)	09 45 200 1560		
<b>Han® 3 A RJ45 HIFF adapter</b> to mount HIFF inserts (e.g. HARTING RJ Industrial® 10G RJ45 bulkhead or Ha-VIS preLink® RJ45) in Han® 3 A housings	09 45 515 0024		



Han® 3 A connector RJ45, 4-poles, Cat. 5

## Advantages

- RJ45 Ethernet-Data connector suitable for industry
- Tool-less field-assembly with HARAX® rapid termination in IDC technology
- Category of transmission Cat. 5
- Compact design and very robust housing
- Suitable for termination of solid and stranded cables
- Up to 10 x reconductable
- PROFINET compatible
- Min. 500 mating cycles

## Technical characteristics

Connector type	Han® 3 A Connector RJ45 acc. to IEC 61076-3-106 variant 5
Number of contacts	4
Transmission performance	Category 5 / Class D up to 100 MHz acc. to ISO/IEC 11801:2002, EN 50 173-1
Transmission rate	10/100 Mbit/s
Shielding	fully shielded, 360° shielding contact
Cable termination	tool-less with IDC contacts
Conductor cross section	
stranded	AWG 24/7 - AWG 22/7
solid	AWG 23/1 - AWG 22/1
Conductor diameter	max. 1.6 mm
Cable outer diameter	6.5 mm – 9.5 mm
Degree of protection	IP65 / IP67
Temperature range	-40 °C ... +70 °C
Housing material	
Plastic version	Polycarbonate, UL 94 V0, black
Metal versions	
Standard	Zinc die-cast, powder coating grey
M-version	Zinc die-cast, powder coating black

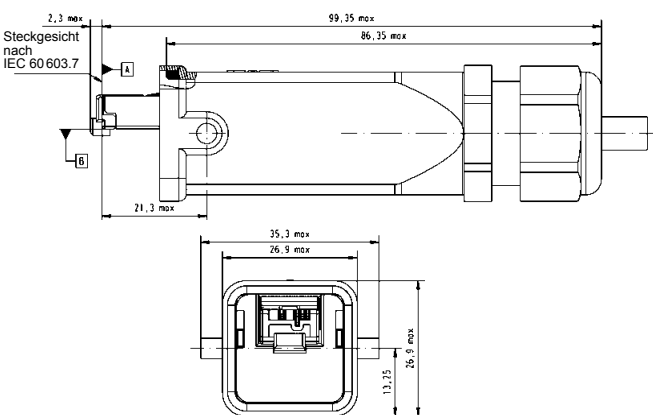
Identification	Part number	Drawing	Dimensions in mm
Han® 3 A connector set RJ45, 4-poles incl. housing, cable gland and instruction manual			
Plastic version, black	straight angled	09 45 125 1100 09 45 125 1104	
Metal version Standard, grey	straight angled	09 45 115 1100 09 45 115 1104	
Metal version M, black	straight angled	09 45 115 1102 09 45 115 1106	
Coding pin set		09 45 820 0000	

Dimensions valid for plastic version, straight





Han® 3 A connector set RJ45, 8-poles, Cat. 6<sub>A</sub>

## Advantages

- RJ45 Ethernet-Data connector suitable for industry
- Field-assembly with mounting tool
- Category of transmission Cat. 6<sub>A</sub>
- Compact design and very robust housing
- Min. 500 mating cycles

## Technical characteristics

Connector type	Han® 3 A Connector RJ45
Number of contacts	8
Transmission performance	Category 6 <sub>A</sub> / Class E <sub>A</sub> up to 500 MHz acc. to ISO/IEC 11801:2002, EN 50 173-1
Transmission rate	10/100 Mbit/s and 1/10 Gbit/s
Shielding	fully shielded, 360° shielding contact
Cable termination	with piercing contacts
Conductor cross section	AWG 28/7 - AWG 24/7, stranded
Conductor diameter	max. 1.05 mm
Cable outer diameter	6.5 mm – 9.5 mm
Degree of protection	IP65 / IP67
Temperature range	-40 °C ... +70 °C
Housing material	Polycarbonate, UL 94 V0, black
Plastic version	
Metal versions	
Standard	Zinc die-cast, powder coating grey
M-version	Zinc die-cast, powder coating black

Identification	Part number	Drawing	Dimensions in mm
Han® 3 A connector set RJ45, 8-poles, Cat. 6 incl. housing, cable gland and instruction manual		<p>Mating face acc. to IEC 60603-7</p>	
Plastic version, black	09 45 125 1520		
Metal version Standard, grey	09 45 115 1520		
Metal version M, black	09 45 115 1522		
Han® 3 A RJ45 connector insert can be combined with Han® 3 A housing	09 45 100 1520		
Coding pin set	09 45 820 0000		
suitable assembly tool	09 45 800 0520		

Dimensions valid for metal version Standard



Han® 3 A RJ45 10G connector, 8-poles, Cat. 6

## Advantages

- RJ45 Ethernet-Data connector suitable for industry
- Tool-less field-assembly with *HARAX*® rapid termination in IDC technology
- Category of transmission Cat. 6
- Compact design and very robust housing
- Suitable for termination of solid and stranded cables
- PROFINET compatible
- Min. 500 mating cycles

## Technical characteristics

Connector type	Han® 3 A Connector RJ45 acc. to IEC 61076-3-106 variant 5
Number of contacts	8
Transmission performance	Category 6 / Class E <sub>A</sub> up to 500 MHz acc. to ISO/IEC 11801:2002, EN 50 173-1
Transmission rate	10/100 Mbit/s and 1/10 Gbit/s
Shielding	fully shielded, 360° shielding contact
Cable termination	tool-less with IDC contacts
Conductor cross section	
stranded	AWG 27/7 - AWG 22/7
solid	AWG 24/1 - AWG 22/1
Conductor diameter	max. 1.6 mm
Cable outer diameter	6.5 mm – 9.5 mm
Degree of protection	IP65 / IP67
Temperature range	-40 °C ... +70 °C
Housing material	
Plastic version	Polycarbonate, UL 94 V0, black
Metal versions	
Standard	Zinc die-cast, powder coating grey

Identification	Part number	Drawing	Dimensions in mm
Han® 3 A RJ45 connector, 8-poles incl. housing, cable gland and instruction manual			
Plastic version, black                      straight	09 45 125 1560		
Metal version Standard, grey              straight	09 45 115 1560		
Han® 3 A RJ45 connector insert                              straight	09 45 100 1560		
can be combined with Han® 3 A housing			
Coding pin set	09 45 820 0000		

Dimensions valid for plastic version, straight



Han® 3 A 2 x LC duplex

## Advantages

- Compact, space-saving Design
- Just one LWL modul for high mechanical load
- High packing density
- A & B parts identification according to TIA 568 standard

## Technical characteristics

Degree of protection	IP65 / IP67
Temperature range	-40 °C ... +70 °C
Housing material	Zinc die-cast powder coating black

Identification	Part number	Drawing	Dimensions in mm
<b>Components device side</b>  Multimode GOF Singlemode GOF	09 57 467 0004 000 09 57 467 0005 000		
<b>Connector</b>  Multimode GOF Singlemode GOF	09 57 407 0001 000 09 57 407 0002 000		



Han® 3 A RJ45 Hybrid

## Advantages

- RJ45 Ethernet-Data connector suitable for industry with Power contacts for hybrid applications
- Field-assembly with mounting tool
- Category of transmission Cat. 5
- Compact design and very robust housing
- Suitable for termination with solid and stranded cables
- Protection against direct contact on cable and device side according to EN 60529

### Reference note:

For cat. 6 patch cords it is recommended to use 1 connector with a white cable manager and one with a blue cable manager, in order to optimise the crosstalk between different signal pairs.

## Technical characteristics

Degree of protection	IP65 / IP67
Mating interface	RJ45, 8-poles acc. to IEC 60603-7 plus 3x power
Temperature range	-40 °C ... +70 °C
Housing material	Zinc die-cast, powder coating black
<b>Data</b>	
Transmission performance	Category 5 / Class D up to 100 MHz acc. to ISO/IEC 11801:2002, EN 50173-1
Transmission rate	10/100/1000 Mbit/s
Shielding	fully shielded, 360° shielding contact
Cable diameter stranded	AWG 28/7 - AWG 24/7
<b>Power</b>	
Number of contacts	3 (AC: L1, PE, N / DC: V+, GND, V-)
Working voltage	300 V AC/DC
Working current	12 A @ 70 °C (see current carrying capacity Han D® contacts)
Cable diameter	2.5 mm <sup>2</sup>

Identification	Part number	Drawing	Dimensions in mm
<b>Components device side</b> incl. 3x Han D® female contacts			
AC version	09 57 368 0500 000		
DC version	09 57 368 0501 000		
<b>Cable side</b> Connector incl. 3x Han D® male contacts			
AC version	09 57 308 0500 000		<p>Recommended panel cutout dimension</p>
DC version	09 57 308 0501 000		
suitable assembly tool	09 45 800 0520		





## Han® 3 A LC duplex Hybrid

### Advantages

- Small form factor (compared to SC and ST®)
- Compact, space-saving Design
- Combined to only one LWL-module for high mechanical load
- High packing density
- A & B parts identification according to TIA 568 standard

### Technical characteristics

Degree of protection	IP65 / IP67
Temperature range	-40 °C ... +70 °C
Data	
Mating module	LC duplex (2 fibres)
Cable diameter	6.0 ... 9.0 mm
Power	
Number of contacts	3 (AC: L1, PE, N / DC: V+, GND, V-)
Working voltage	300 V AC/DC
Working current	12 A @ 70°C
Housing material	Aluminium die-cast, black

Identification	Part number	Drawing	Dimensions in mm	
<b>Components device side</b>				
Power: 3x Han D® male contacts				
Data: Multimode GOF	AC DC	09 57 568 0500 000 09 57 568 0510 000		
Data: Singlemode GOF	AC DC	09 57 568 0501 000 09 57 568 0511 000		
<b>Connector</b>				
Power: 3x Han D® female contacts				
Data: Multimode GOF	AC DC	09 57 508 0500 000 09 57 508 0510 000		
Data: Singlemode GOF	AC DC	09 57 508 0501 000 09 57 508 0511 000		

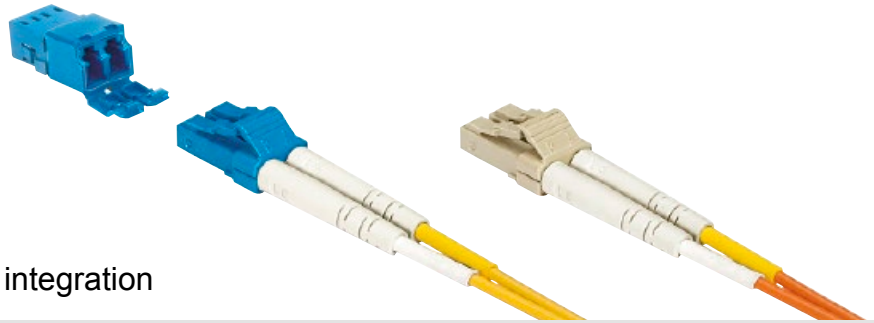

LC duplex IP20 adapter for device integration

## Advantages

- Small form factor (compared to SC and ST®)
- Compact, space-saving Design
- High packing density
- A & B parts identification according to TIA 568 standard
- Complement adapter for IP67 connector on device side

## Technical characteristics

Degree of protection	IP20
Mating interface	LC duplex with two fibres
Temperature range	-40 °C ... +70 °C

Identification	Part number	Drawing	Dimensions in mm															
<b>Device side Adapter</b>  Multimode GOF  Singlemode GOF	09 57 400 0003 000  09 57 400 0004 000		<table border="1"> <thead> <tr> <th></th> <th>min.</th> <th>max.</th> </tr> </thead> <tbody> <tr> <td>G</td> <td>26.60</td> <td>26.80</td> </tr> <tr> <td>H</td> <td>9.35</td> <td>9.45</td> </tr> <tr> <td>J</td> <td>12.80</td> <td>12.90</td> </tr> <tr> <td>K</td> <td>15.24</td> <td>15.34</td> </tr> </tbody> </table>		min.	max.	G	26.60	26.80	H	9.35	9.45	J	12.80	12.90	K	15.24	15.34
	min.	max.																
G	26.60	26.80																
H	9.35	9.45																
J	12.80	12.90																
K	15.24	15.34																
<b>Connector LC duplex</b>  Multimode GOF  Singlemode GOF	09 57 400 0001 000  09 57 400 0002 000																	



Han® 3 A RJ45, Hybrid

## General information

With the RJ Industrial Hybrid connector, HARTING has developed an interface solution that integrates the data lines and the power supply into one connector for hybrid Ethernet networks. The connector's geometry nevertheless maintains a clear separation between the data and the power contacts. This brings a significant reduction in the costs of installation and of field devices suitable for industrial application with hybrid cabling.

The panel feed-through is compatible with RJ45 connectors, which means that the standard patch cables for service and test purposes can be used. The data lines are connected at the rear via an RJ45 jack, while the power lines use a cage clamp terminal.

Optional the hybrid interface can be integrated in the device directly, thus preventing the use of rear side data lines.

The four power contacts of the hybrid module have also been designed with HARAX® rapid termination technology, allowing stranded cables of up to 1.5 mm<sup>2</sup> to be connected.

Current carrying capacity „Power contacts“

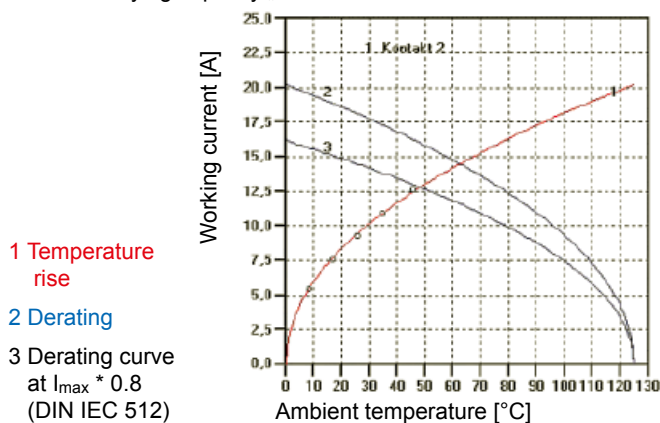

## Technical characteristics

Connector	
Degree of protection	IP65 / IP67
Mating interface	RJ45, 4-poles acc. to IEC 60603-7 plus 4x power
Temperature range	-40 °C ... +70 °C
Housing material	
Plastic version	UL 94 V0, black
Metal version	Zinc die-cast, grey
Mating cycles	min. 500
Mounting	field-assembly
Data Cat. 5, 4-poles	
Transmission performance	Category 5 / Class D up to 100 MHz acc. to ISO/IEC 11801:2002, prEN 50173-1
Transmission rate	10/100 Mbit/s
Cable diameter	
stranded	AWG 24/7 - AWG 22/7
solid	AWG 23/1 - AWG 22/1
Data Cat. 6, 8-poles	
Transmission performance	Category 6 / Class EA up to 500 MHz acc. to ISO/IEC 11801:2002, prEN 50173-1
Transmission rate	10/100 Mbit/s / 1 Gbit/s
Cable diameter	
stranded / solid	AWG 27 - AWG 22
Both, data Cat. 5 and Cat. 6	
Shielding	fully shielded, 360° shielding contact
Cable outer diameter	10.0 mm – 11.0 mm
Power	
Number of contacts	4 for cable diameter 1.5 mm <sup>2</sup> stranded
Working voltage	48 V
Working current	16 A, see current carrying capacity
	UL approved (E102079)
Panel feed-through	
Mating interface extern:	RJ45 female acc. to IEC 60603-7 plus 4 x power
Mating interface intern:	RJ45 female acc. to IEC 60603-7 4 x power via cable cage clamp 1.5 mm <sup>2</sup>



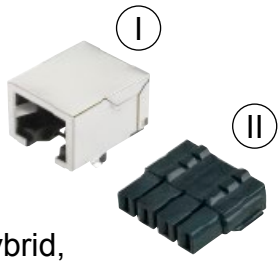

Han® 3 A, Hybrid,  
components device side  
panel feed-throughs

Identification	Part number	Drawing	Dimensions in mm
<p><b>RJ45 female</b> for direct device integration</p> <p>solder variant SMD 90° angled</p> <p>I</p>	<p>09 45 551 1100<sup>1)</sup></p> <p>09 45 551 1110<sup>2)</sup></p>		<p>pcb layout</p>
<p><b>Power module with 4 contacts</b> for direct device integration</p> <p>Reel with 100 pieces</p> <p>II</p>	<p>09 45 525 0040</p> <p>09 45 525 0041</p>		<p>recommended PCB power layout (SMD) scale: 4:1</p>
<p><b>Housing bulkhead mounting separate</b> incl. flat seal for direct device integration</p> <p>Plastic version, black Metal version Standard, grey Metal version M, black Metal version EMC, unpainted</p> <p>III</p>	<p>09 45 525 0021</p> <p>10 12 005 1004</p> <p>09 45 525 0027</p> <p>09 45 525 0028</p>		<p>Dimensions valid for plastic version</p>
<p><b>Panel feed-through set</b></p> <p>Plastic version, black, Cat. 5 Metal version Standard, grey, Cat. 5 Metal version M, black, Cat. 5 Metal version Standard, grey, Cat. 6 Metal version M, black, Cat. 6</p> <p>IV</p>	<p>09 45 225 1300</p> <p>10 12 005 1002</p> <p>09 45 215 1301</p> <p>09 45 215 1760</p> <p>09 45 215 1761</p>		
<p><b>Protection cover for panel feed-through</b> IP65 / IP67</p> <p>Plastic version, black Metal version Standard, grey Metal version M, black</p>	<p>09 20 003 5449</p> <p>09 20 003 5425</p> <p>09 37 003 5405</p>		



PROFINET Type B cable, Hybrid  
Industrial Cat. 5 Hybrid cable, 4-wire + 4x Power  
to make up Hybrid system cables

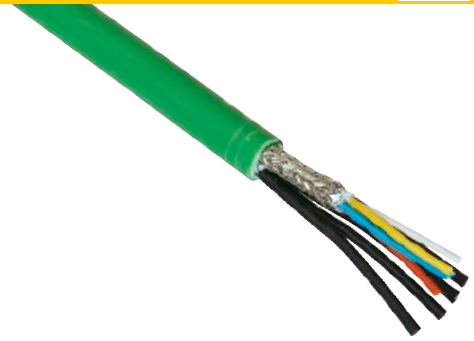

Han

## Advantages

- Robust design for industrial environment
- PROFINET-conform
- Additional power supply
- Hybrid Cat. 5 cable, 4-wire + 4x Power

## Technical characteristics

Cable construction	Star quad + 4 Power cables, double shielded
Core structure	4 x AWG 22/7 + 4 x 1.5 mm <sup>2</sup> (conductor 84 x 0.15 mm <sup>2</sup> )
Sheath material	FRNC
Cable outer diameter	9.7 mm
Transmission performance	Category 5 / Class D up to 100 MHz acc. to ISO/IEC 11801:2002, EN 50173-1
Transmission rate	10/100 Mbit/s
Shielding	Shielding foil and shielding braid
Temperature range	-20 °C ... +70 °C
Standard lengths	10 m / 20 m / 50 m / 100 m
Colour	green

### Identification

PROFINET Type B cable, Hybrid  
Industrial Cat. 5 Hybrid cable,  
4-wire + 4x Power

10 m ring  
20 m ring  
50 m ring  
100 m ring  
500 m reel

### Part number

09 45 600 0310  
09 45 600 0330  
09 45 600 0340  
09 45 600 0300  
09 45 600 0320

### Drawing

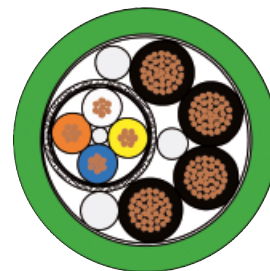

### Dimensions in mm



Industrial Cat. 6 Hybrid  
Installation cable, 8-wire

## Advantages

- Robust design for industrial environment
- PROFINET-conform
- Additional power supply
- Hybrid Cat. 6 cable, 4-wire + 4x Power

## Technical characteristics

Cable structure	4 x 2, Twisted Pair, shielded, PIMF 4 power cores
Core structure	4 x 2 x AWG 26/7, stranded 4x 84 * 0.15 mm (cord 1.5 mm²), stranded
Sheath material	PUR
Cable sheath diameter	10 ... 10.6 mm
Transmission performance	Category 6 / Class E up to 250 MHz according to ISO/IEC 11801:2002, EN 50 173-1
Transmission rate	10/100/1000 Mbit/s
Shielding	Paired shielded with additional cable shield
Operating temperature range	-20 °C ... +80 °C
Supply lengths	20 m / 50 m / 100 m other lengths on request
Colour	black

### Identification

Industrial Cat. 6 Hybrid  
installation cable,  
8-wire  
PUR

20 m ring  
50 m ring  
100 m drum

### Part number

09 45 600 0332  
09 45 600 0342  
09 45 600 0302

### Drawing



### Dimensions in mm

## Features

### General Description

The Han-Brid® series allows the connection of a data interface and a power supply in a single space saving connector. This means that it is now possible to provide data transmission and power to devices in a single bus structure. This hybrid connector family includes provision for connection of a max. 50 V, 10 A power supply together with a range of inserts for connection of a variety of data protocols and transmission medias:

- Han-Brid® F.O. for plastic (POF) or for HCS®\* optical fibre
- Han-Brid® Cu for shielded twisted pair.
- Han-Brid® Quintax 3 A for shielded 4 wire bus systems (2 pair STP)
- Han-Brid® RJ45 C for Ethernet application
- Han-Brid® USB / Firewire for fast data transmission

Han-Brid® inserts fit to the standard plastic as well as metal hoods and housings with seal of the Han® 3A series offering a degree of protection IP65 according to DIN EN 60 529. For harsher environments Han® 3 HPR hoods and housings with a degree of protection of IP68 can be used.

## Power supply

- Han D® male and female with standard crimp contacts
- Rated current 10 A
- Rated voltage 50 V
- Wire gauge 0.14 - 2.5 mm<sup>2</sup>
- Approval 

## Data interfaces

### Han-Brid® F.O.

- Is suitable for all HP Versatile Link (Horizontal Package) transmitters and receivers
- Data rates: Standard 12 Mbit/s, suitable for all common fieldbus systems
- Insert allows integration of HP standard contacts for POF and HCS®\* fibres
- Temperature range                    -40 °C ... +70 °C

### Han-Brid® Cu

- For termination of a shielded twisted pair
- Insert for 2x Han D® male or female contacts
- Connection of the shield by means of shielding plate and fixing clamps
- Connection of the device side can be realized either by a printed circuit board as a modular version or as part of the appliance PCB
- Insert for bulkhead mounted housing or the coupling housing are always equipped with a screening spring

### Bus Terminator

- Active bus terminator in male and female version
- Standard Han® 3 A hoods and housings
- Power supply to the termination network via electrical contacts of Han-Brid®
- Integrated, galvanically separated DC/DC converter 24 V / 5 V

### Han-Brid® Quintax 3 A

- Possibility to terminate shielded 4 wires conductors (2 pair STP)
- Suitable for all 4-wire bus systems
- Suitable for shielded cable conductor diameter 3 – 9.5 mm
- Transmission of shielding separately from the hood's ground
- Connections are carried out acc. to DIN EN 50 173, Cat. 5
- Temperature range                    -40 °C ... +70 °C

### Han-Brid® RJ45 C

- Suitable for standard RJ45 Plug and Jack, shielded version
- Connections provided for conductors acc. to DIN EN 50 173, Cat. 5
- Termination from the device side is carried out via a PCB, two versions are possible: modular version or as part of the appliance PCB
- Assembly with standard tools
- Insert for 2 Han-D® male or female contacts offers the combination with electrical bus connector
- Rated current                            10 A
- Rated voltage                            24 V
- Wire gauge                                0.14 - 2.5 mm<sup>2</sup>

### Han-Brid® USB

- Insert for all Han® 3 A hoods and housings
- Hood with glued sealing
- Simple and low-cost termination via insert of a patch cable
- Strain-relief via cable tie

### Han-Brid® FireWire

- Insert for all Han® 3 A hoods and housings
- Hood with glued sealing
- Simple and low-cost termination via insert of a patch cable
- Strain-relief via cable tie
- Compatible to IEEE 1394

\* HCS® Hard Clad Silica (is registered trade mark of the SpecTran Corporation)

## Overview (Sample: Han-Brid® Cu)

Thermoplastic  
 09 20 003 0320 (light grey)  
 09 20 003 0327 (black)

Metal  
 09 20 003 0301

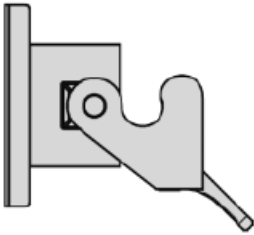

Device side  
 09 12 006 2611  
 09 12 006 2695  
 09 12 006 2694

Cable side  
 09 12 006 3111

Thermoplastic  
 09 20 003 0423 (light grey)  
 09 20 003 0426 (black)  
 19 20 003 0423 (light grey)  
 19 20 003 0427 (black)

Metal  
 09 20 003 1443  
 19 20 003 1443

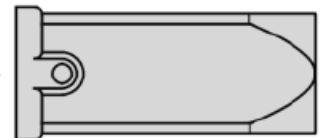

Thermoplastic  
 09 20 003 0720 (light grey)  
 09 20 003 0727 (black)  
 19 20 003 0720 (light grey)  
 19 20 003 0727 (black)

Metal  
 09 20 003 1750  
 19 20 003 1750

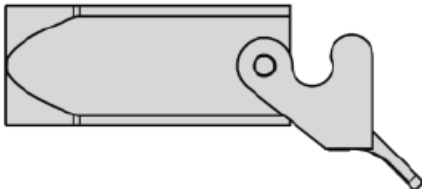

Device side  
 09 12 006 2701  
 09 12 006 2795  
 09 12 006 2794

Cable side  
 09 12 006 3001

Thermoplastic  
 09 20 003 0623 (light grey)  
 09 20 003 0626 (black)  
 19 20 003 0623 (light grey)  
 19 20 003 0627 (black)

Metal  
 09 20 003 1643  
 19 20 003 1643

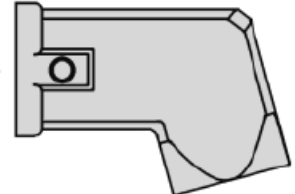



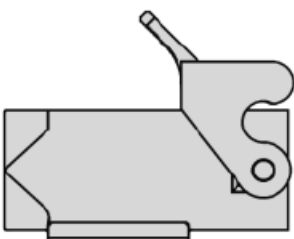

Thermoplastic  
 09 20 003 0220 (light grey)  
 09 20 003 0227 (light grey)  
 19 20 003 0220 (light grey)  
 19 20 003 0227 (black)

Metal  
 09 20 003 1250  
 19 20 003 1250

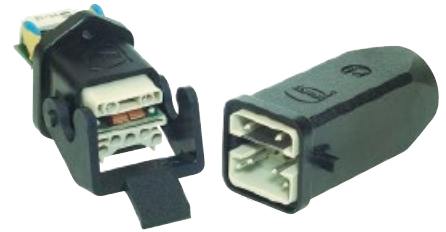



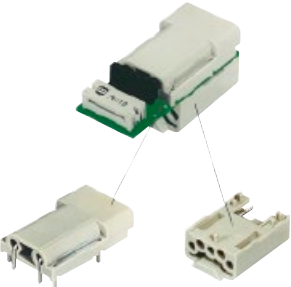
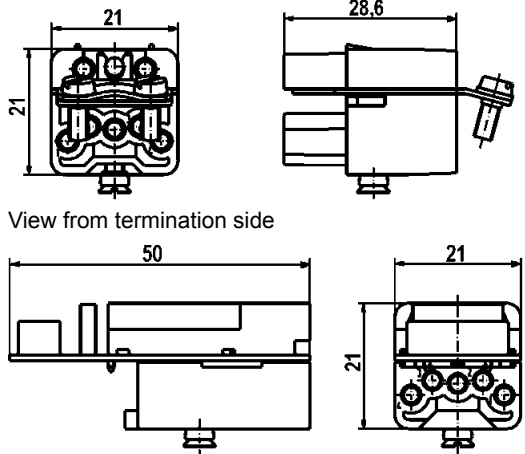

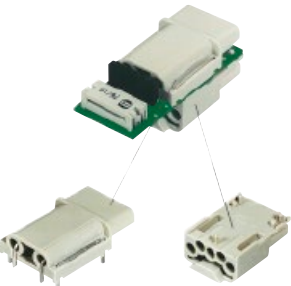
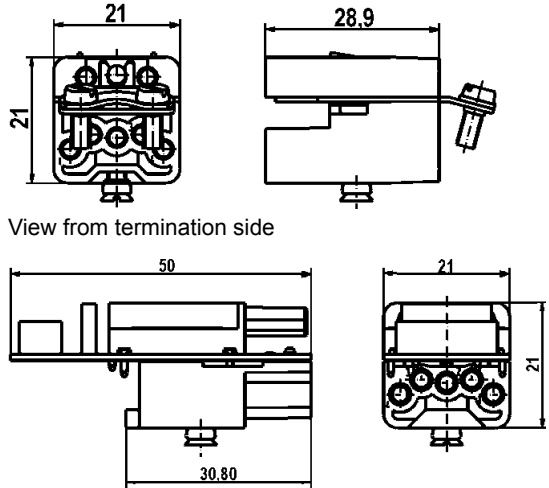
Hybrid field bus connector  
for shielded twisted pair  
+ 4 electrical contacts 10 A  
+ option for PE

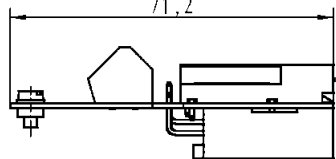
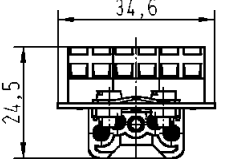
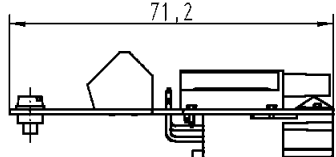
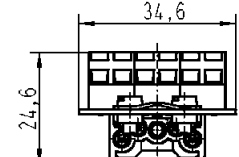

Identification	Part number		Drawing	Dimensions in mm
	Male insert (M)	Female insert (F)		
<p>Cable side Female insert</p>  <p>Device side Male insert</p> 	<p><b>09 12 006 3111</b></p>		 <p>View from termination side</p>	
	<p>09 12 006 2611</p> <p>Also available as single part</p> <p>loaded 09 12 002 2611 unloaded 09 12 002 3011</p>	<p>Also available as single part</p> <p>unloaded 09 12 004 3011</p>		
<p>Cable side Male insert</p>  <p>Device side Female insert</p> 	<p><b>09 12 006 3001</b></p>		 <p>View from termination side</p>	
	<p>09 12 006 2701</p> <p>Also available as single part</p> <p>loaded 09 12 002 2701 unloaded 09 12 002 3101</p>	<p>Also available as single part</p> <p>unloaded 09 12 004 3101</p>		

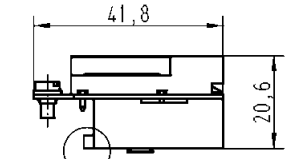
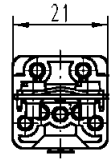
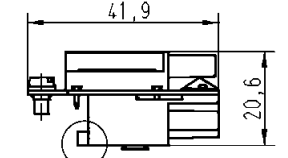
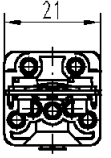

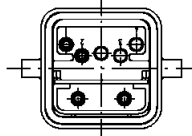
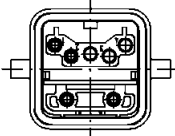
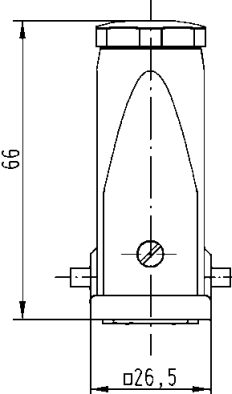
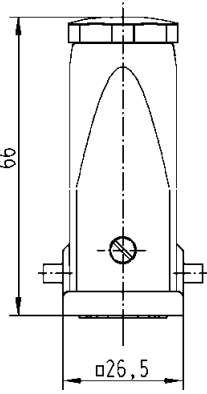
Identification	Part number		Drawing	Dimensions in mm
	Male insert (M)	Female insert (F)		
<p>Panel feed-through with cage clamp</p> 	<b>09 12 006 2695</b>		 	<p>71,2</p> <p>34,6</p> <p>24,5</p>
		<b>09 12 006 2795</b>	 	<p>71,2</p> <p>34,6</p> <p>24,6</p>
<p>Coupling / Panel feed-through</p>  <p>X = Cutting off the fin allows the use in cable to cable housings</p>	<b>09 12 006 2694</b>		  <p>X</p>	<p>41,8</p> <p>21</p> <p>20,6</p>
		<b>09 12 006 2794</b>	  <p>X</p>	<p>41,9</p> <p>21</p> <p>20,6</p>
<p>Bus terminator</p> <p>Plastic hoods/housings</p>  <p>Hoods/Housings, metal</p> 	<b>09 12 006 2691</b>	09 12 006 2791	 	
	<b>09 12 006 2692</b>	09 12 006 2792	 	<p>66</p> <p>66</p> <p>∅26,5</p> <p>∅26,5</p>

Hybrid field bus connector  
with F.O. transmitter and receiver  
+ 4 electrical contacts 10 A  
+ option for PE

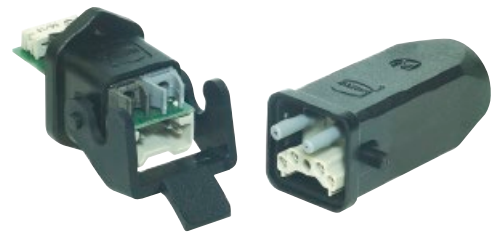

Identification	Part number		Drawing	Dimensions in mm
	Male insert (M)	Female insert (F)		
<p>Cable side F.O. (m) + Han D® (f)</p>	<p>Also available as single part</p> <p>for POF 09 12 004 2711</p> <p>for POF crimpless 09 12 004 2713</p> <p>for HCS®* fibre 09 12 004 2716</p>	<p>Also available as single part</p> <p>for POF 09 12 004 3111</p> <p>for POF crimpless 09 12 004 3113</p> <p>for HCS®* fibre 09 12 004 3116</p>	<p>View from termination side</p>	
<p>Device side F.O. (f) + Han D® (m)</p>	<p>for POF 09 12 004 2611</p> <p>for POF crimpless 09 12 004 2611</p> <p>for HCS®* fibre 09 12 004 2611</p>	<p>for POF 09 12 004 3011</p> <p>for POF crimpless 09 12 004 3011</p> <p>for HCS®* fibre 09 12 004 3011</p>	<p>View from termination side</p>	
<p>Cable side F.O. (m) + Han D® (m)</p>	<p>Also available as single part</p> <p>for POF 09 12 004 2601</p> <p>for POF crimpless <b>09 12 004 2603</b></p> <p>for HCS®* fibre 09 12 004 2606</p>	<p>Also available as single part</p> <p>for POF 09 12 004 3001</p> <p>for POF crimpless 09 12 004 3003</p> <p>for HCS®* fibre <b>09 12 004 3006</b></p>	<p>View from termination side</p>	
<p>Device side F.O. (f) + Han D® (f)</p>	<p>for POF 09 12 004 2701</p> <p>for POF crimpless 09 12 004 2701</p> <p>for HCS®* fibre 09 12 004 2701</p>	<p>for POF 09 12 004 3101</p> <p>for POF crimpless 09 12 004 3101</p> <p>for HCS®* fibre 09 12 004 3101</p>	<p>View from termination side</p>	

\* HCS®=Hard Clad Silica (is registered trade mark of the SpecTran Corporation)

4 contacts + shielding  
+ 2 power contacts  
suitable in Han® 3 A metric  
hoods and housings



Identification	Part number		Drawing	Dimensions in mm
	Male insert (M)	Female insert (F)		
Quintax insert 	<b>09 15 003 3001</b>	<b>09 15 003 3101</b>		
Quintax contacts Zinc alloy Order crimp contacts separately  Special clamp for cable diameter 3 - 6 and 6 - 9.5 mm included in delivery range	<b>09 15 004 3013</b>	<b>09 15 004 3113</b>		

## Assembly instructions

### Quintax-Z-contact

- Strip cable acc. to drawing 1 and fold the shielding over the cable.
- Crimp Han D® contacts onto the wires.
- Insert Han D® contacts into corresponding cavities of insulator until they are snapped in.
- Fit the insert including the cable into the opened shielded bushing. The coding pin of the shielded bushing has to meet the groove of the insulator.
- Clamp the tilt over the shielding onto the cable by means of the special clamp (small opening for cable diameter of 3 - 6 mm, large opening for cable diameter of 6 - 9.5 mm).
- Check the wiring.
- Close the shielded bushing with the cover and insert it into the corresponding cavity of the Quintax Module as usual.

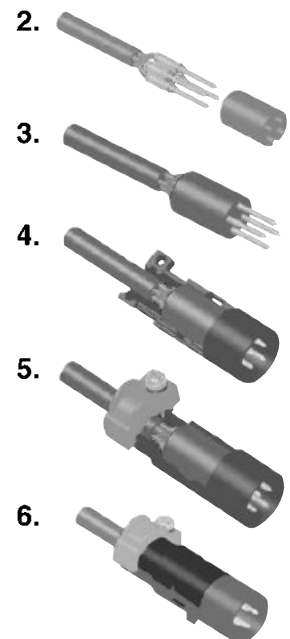
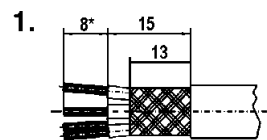





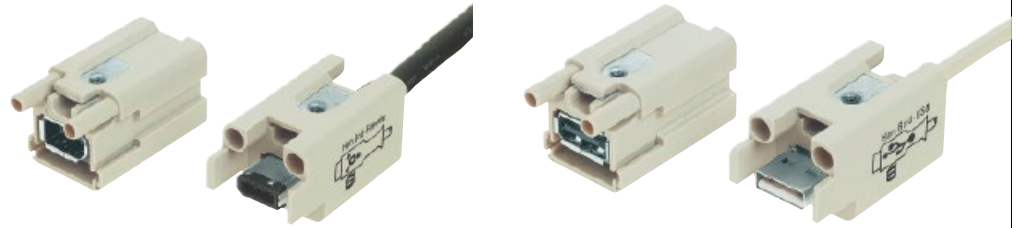

Identification	Part number		Drawing	Dimensions in mm
	Male insert (M)	Female insert (F)		



**09 12 001 2794**

**09 12 001 3091**

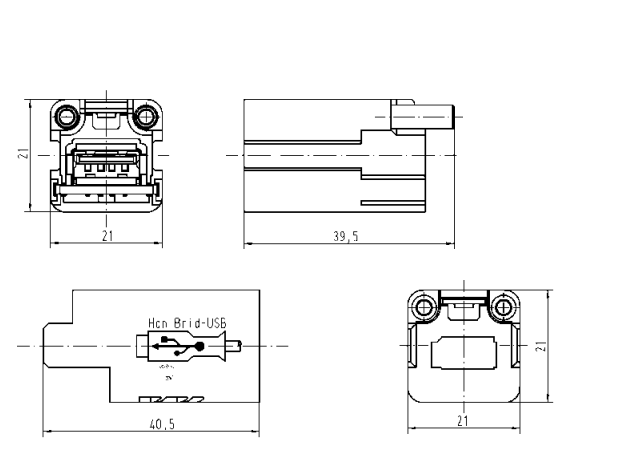

**09 12 001 2774**

**09 12 001 3071**

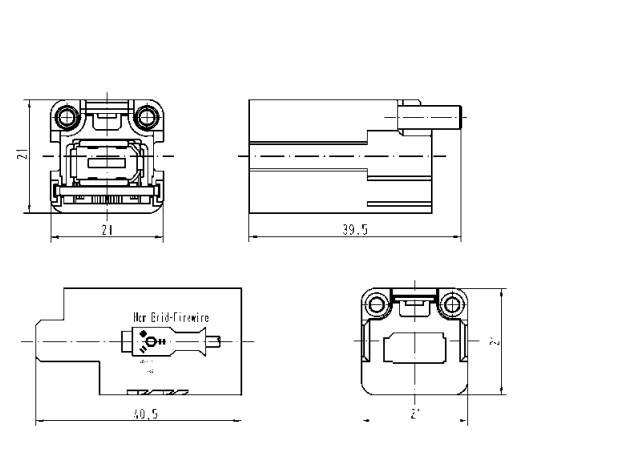



Insert	Part number		Drawing	Dimensions in mm
	Male insert (M)	Female insert (F)		
Order contacts separately	<b>09 12 005 3001</b>	<b>09 12 005 3101</b>	<p>1) Distance for contact max. 21 mm</p>	
PCB-adapter	Part number		Drawing	Dimensions in mm
with PE contact panel for Han® Q 5/0	<b>09 12 000 9905</b>		<p>Adapter</p>	<p>PE contact panel</p>
Solder contacts	Part number		Drawing	Dimensions in mm
to connect the PCB-adapter	<b>09 33 000 6195</b>	<b>09 33 000 6295</b>		
Housing bulkead mounting	Part number		Drawing	Dimensions in mm
	<b>09 62 003 0304</b>		Panel cut out 22 x 22 mm 	

Han

Device side

Cable side

## Features

- ❑ Robust design
- ❑ Suitable for EMC housings
- ❑ Low wiring costs
- ❑ Additional robust and secure PE-connection between housing and PCB

## Technical characteristics

### Approvals



### Inserts

Number of contacts 5

Electrical data acc. to DIN EN 61984

**10 A 230/400 V 4 kV 3**

Working current  
 Working voltage conductor – ground  
 Working voltage conductor – conductor  
 Rated impulse voltage  
 Pollution degree

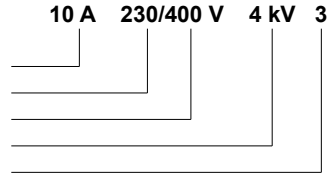

- pollution degree 2 also 10 A 320/500 V 4 kV 2

Working voltage acc. to UL/CSA 400 V

Insulation resistance  $\geq 10^{10} \Omega$   
 Material Polycarbonate  
 Limiting temperatures  $-40^\circ\text{C} \dots +125^\circ\text{C}$   
 Flammability acc. to UL 94 V0  
 Mechanical working life  
 - Mating cycles  $\geq 500$

## Layout of printed circuit boards

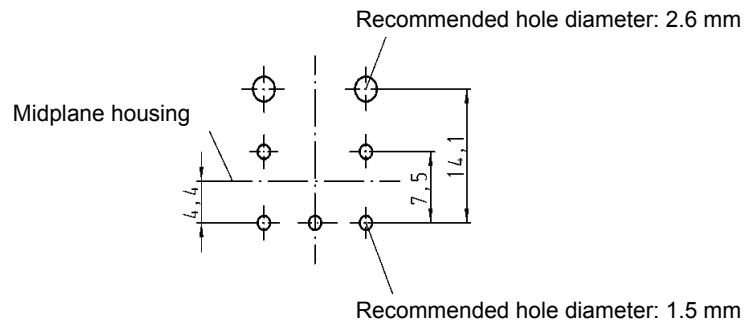

## Assembly situation

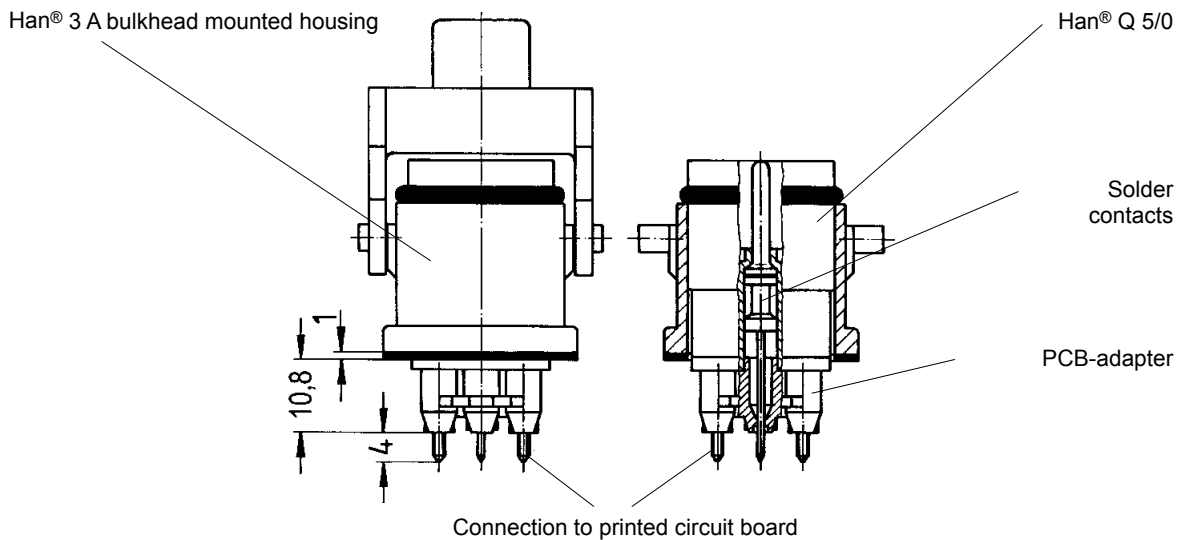





Han

Device side

Insert	Part number		Drawing	Dimensions in mm
	Male insert (M)	Female insert (F)		
Order contacts separately	<b>09 12 007 3001</b>	<b>09 12 007 3101</b>		
Coding	<b>09 12 000 9901</b>	<b>09 12 000 9902</b>		

PCB-adapter	Part number	Drawing	Dimensions in mm
for PCB up to 2.4 mm	<b>09 12 000 9908</b>		

Solder contacts	Part number		Drawing	Dimensions in mm
	Male contact	Female contact		
to connect the PCB-adapter	<b>09 15 000 6190</b>	<b>09 15 000 6290</b>		

Housing bulkead mounting	Part number	Drawing	Dimensions in mm
	<b>09 20 003 0301</b>	Panel cut out 22 x 22 mm 	

Cable side

Further informations see HARTING catalogue "Industrial Connectors Han®, chapter Q"

## Features

- ❑ Robust design
- ❑ Suitable for standard and EMC housings
- ❑ Low cost wiring
- ❑ High contact density

## Technical characteristics





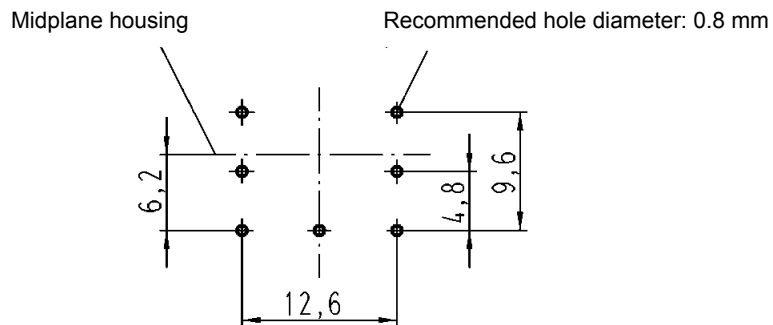



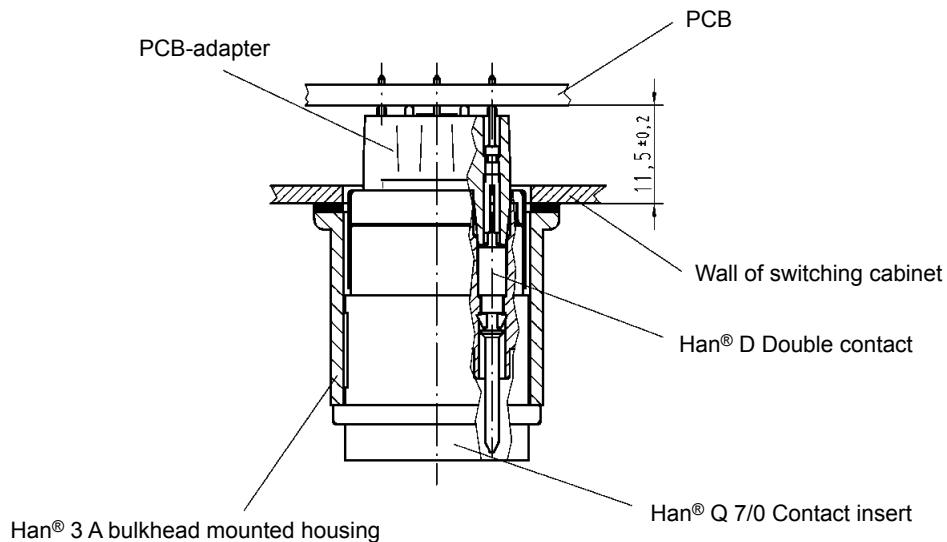

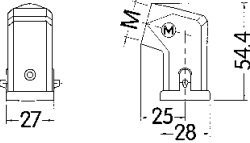
Approvals	
Inserts	
Number of contacts	7
Electrical data acc. to DIN EN 61984	<b>7.5 A 250 V 4 kV 3</b>
Working current	
Working voltage	
Rated impulse voltage	
Pollution degree	
Insulation resistance	≥ 10 <sup>10</sup> Ω
Material	Polycarbonate
Limiting temperatures	-40 °C ... +125 °C
Flammability acc. to UL 94	V0
Mechanical working life	
- Mating cycles	≥ 500

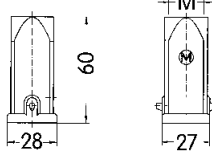
## Layout of printed circuit boards

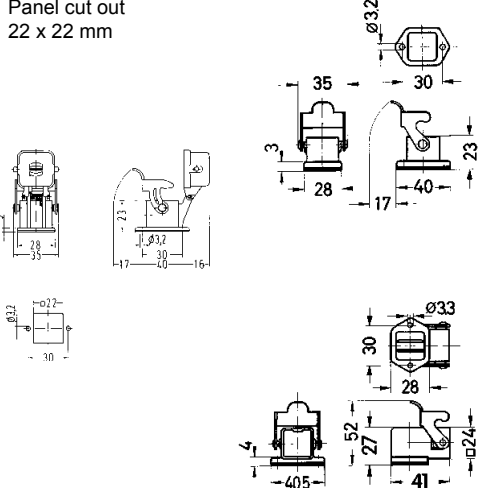

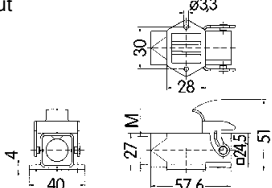
## Assembly situation

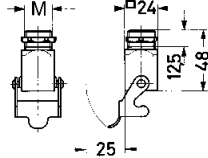

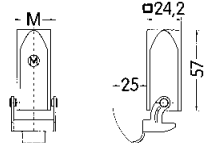
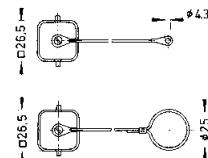
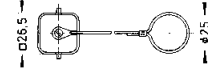
Identification		Part number	M	Drawing	Dimensions in mm
Hoods	Hood side-entry 	<b>19 20 003 1640</b>	20		
	Hood top-entry 	<b>19 20 003 1440</b>	20		
	Protection covers for hoods	<b>09 20 003 5422<sup>1)</sup></b> <b>09 20 003 5421<sup>2)</sup></b>			
Housings	Housings bulkhead mounting 	<b>09 20 003 0301</b>		Panel cut out 22 x 22 mm 	
	with fixed cover	<b>09 20 003 0305<sup>1)</sup></b>			
	without sealing	<b>09 20 003 0306<sup>2)</sup></b>			
	with sealing	<b>09 20 003 0801</b>			
	Housing surface mounting 1 side-entry bottom closed 	<b>19 20 003 1250</b>	20	Panel cut out 22 x 22 mm 	
		<b>19 20 003 1252</b>	20		
	Housing screw mounting 	<b>19 20 003 1150</b>	20		
Hood cable to cable 	<b>19 20 003 1750</b>	20			
Protection covers for housings	<b>09 20 003 5426<sup>1)</sup></b> <b>09 20 003 5425<sup>2)</sup></b>				
for hoods cable to cable	<b>09 20 003 5428<sup>1)</sup></b> <b>09 20 003 5427<sup>2)</sup></b>				

<sup>1)</sup> for mounted male insert  
<sup>2)</sup> for mounted female insert

Identification		Part number	M	Drawing	Dimensions in mm	
Hoods	Hoods side-entry	grey 19 20 003 0620 black 19 20 003 0627	20 20			
	Hoods top-entry	grey <b>19 20 003 0420</b> black 19 20 003 0427	20 20			
	Protection covers for hoods	09 20 003 5442 <sup>1)</sup> 09 20 003 5441 <sup>2)</sup>				
Housings	Housings bulkhead mounting	grey <b>09 20 003 0320</b> black <b>09 20 003 0327</b> grey <b>09 20 003 0820</b> black <b>09 20 003 0827</b>	- - - -	Panel cut out 22 x 22 mm 		
	Housings surface mounting 1 side-entry	grey <b>19 20 003 0220</b> black <b>19 20 003 0227</b>	20 20	Panel cut out 22 x 22 mm 		
	Hoods cable to cable	grey <b>19 20 003 0720</b> black 19 20 003 0727	20 20			
	Protection covers	for housings A	09 20 003 5407 <sup>1)</sup> <b>09 20 003 5408<sup>2)</sup></b>			
		for hoods cable to cable C	09 20 003 5445 <sup>2)</sup> 09 20 003 5446 <sup>1)</sup> 09 20 003 5447 <sup>2)</sup> 09 20 003 5448 <sup>1)</sup> 09 20 003 5449 <sup>2)</sup>			

Han

1) for mounted male insert  
2) for mounted female or Han-Brid® insert  
3) for metal housings and cable to cable hoods also

Stock items in bold type



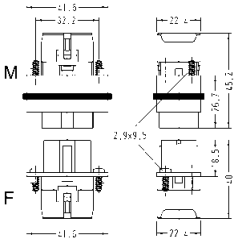
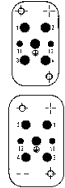

Han

Device side

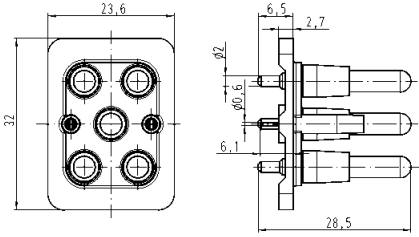
Insert	Part number		Drawing	Dimensions in mm
	Male insert (M)	Female insert (F)		
Order contacts separately 	<b>09 12 006 3041</b>	<b>09 12 006 3141</b>	 <p>Contact arrangement View from termination side</p> 	

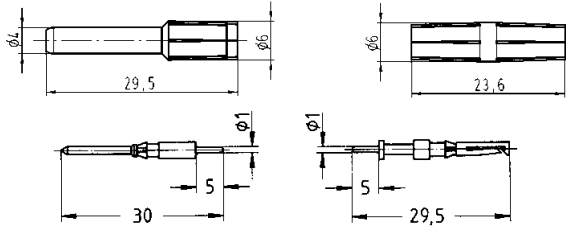
PCB-adapter	Part number	Drawing	Dimensions in mm
for PCBs up to 2.4 mm 	<b>09 12 006 9901</b>		

Han® Q 4/2 double contacts	Part number		Drawing	Dimensions in mm
	Male contact	Female contact		
to connect the PCB adapter Power contact 	<b>09 32 000 6180</b>	<b>09 32 000 6280</b>		
Signal contact 	<b>09 15 000 6191</b>	<b>09 15 000 6293</b>		

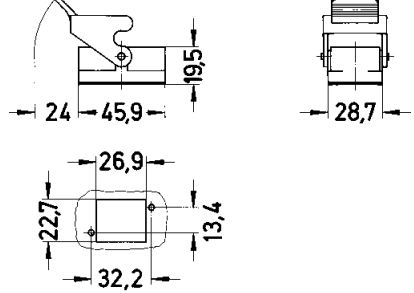
Housing bulkead mounting	Part number	Drawing	Dimensions in mm
Plastic 	<b>09 12 008 0327</b>	Panel cut out 	

Cable side

Further informations see HARTING catalogue "Industrial Connectors Han®, chapter Q"

## Features

- ❑ Robust Design
- ❑ Suitable for Han-Compact® hoods and housings
- ❑ Low wiring costs
- ❑ High contact density

## Technical characteristics

Approvals	
Number of contacts	4/2 + PE
Electrical data acc. to DIN EN 61984	
Power area	30 A 400/690 V 6 kV 2
Rated current	30 A
Rated voltage	
conductor - ground	400 V
conductor - conductor	690 V
Rated impulse voltage	6 kV
Pollution degree	2
Signal area	7.5 A 250 V 4 kV 2
Rated current	7.5 A
Rated voltage	250 V
Rated impulse voltage	4 kV
Pollution degree	2
Insulation resistance	$\geq 10^{10} \Omega$
Material	LCP
Limiting temperatures	-40 °C ... +125 °C
Flammability acc. to UL 94	V0
Mechanical working life	$\geq 500$ mating cycles

## Layout of printed circuit boards

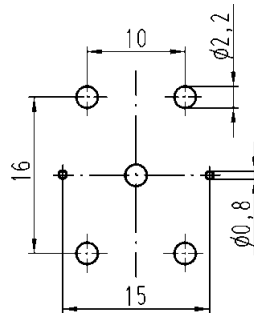

## Assembly situation

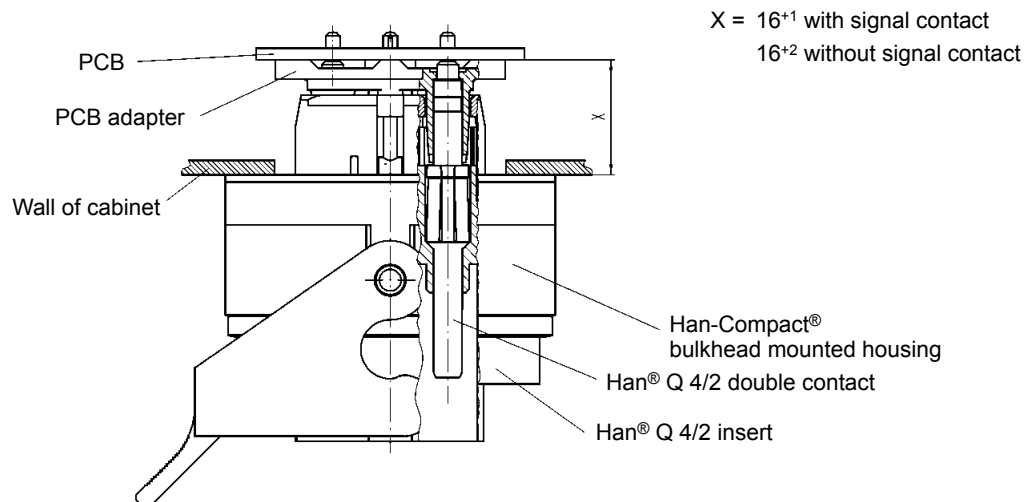



Insert	Part number		Drawing	Dimensions in mm
	Male insert (M)	Female insert (F)		
Order contacts separately 	<b>09 12 008 3001</b>	<b>09 12 008 3101</b>		Contact arrangement View from termination side 
PCB-adapter	Part number		Drawing	Dimensions in mm
for PCBs up to 1.6 mm	<b>09 12 008 9901</b>			
	<b>09 12 008 9901</b>			
Han® Q 8/0 double contacts	Part number		Drawing	Dimensions in mm
to connect the PCB adapter	Male contact	Female contact		
	<b>09 33 000 6180</b>	<b>09 33 000 6280</b>		
Housing bulkead mounting	Part number		Drawing	Dimensions in mm
Plastic	<b>09 12 008 0327</b>			
	<b>09 12 008 0327</b>		Panel cut out 	

Device side

Cable side

Further informations see HARTING catalogue "Industrial Connectors Han®, chapter Q"

## Features

- ❑ Robust Design
- ❑ Suitable for Han-Compact® hoods and housings
- ❑ Low wiring costs
- ❑ High contact density

## Technical characteristics

Approvals	
Number of contacts	8
Electrical data acc. to DIN EN 61984	16 A 230/400 V 4 kV 2
Rated current	16 A
Rated voltage	230 V
conductor - ground	400 V
Rated impulse voltage	4 kV
Pollution degree	2
Insulation resistance	$\geq 10^{10} \Omega$
Material	LCP
Limiting temperatures	-40 °C ... +125 °C
Flammability acc. to UL 94	V0
Mechanical working life	$\geq 500$ mating cycles

## Layout of printed circuit boards

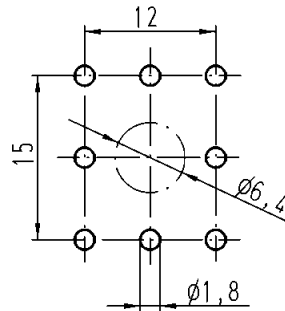

## Assembly situation

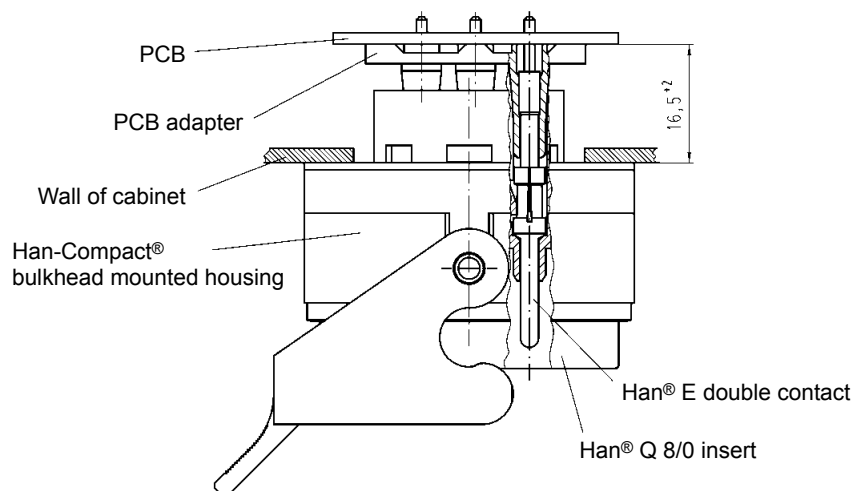



thermoplastic / metal

Identification

Part number

Drawing

Dimensions in mm

Hoods

Hoods

Thermoplastic  
side-entry  
Cable gland order separately



**09 12 008 0527**

Pg 16

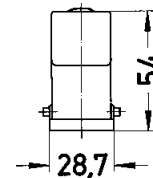
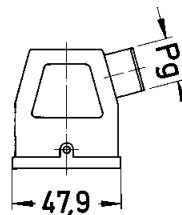

Hoods

Thermoplastic  
top-entry  
Cable gland order separately



**19 12 008 0429**  
**09 12 008 0427**  
**09 12 008 0429**

M 25  
Pg 16  
Pg 21

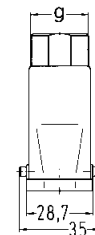
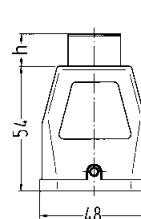

h	g
14	M 25x1.5
13	Pg 16
13	Pg 21

Hoods

Thermoplastic  
top-entry  
Cable gland order separately



**09 12 008 0428**

Pg 16

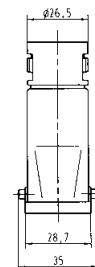
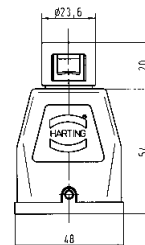

Cable seal

Thermoplastic  
for hoods  
Thrust bolt and insert



**09 00 000 5059**  
**19 12 000 5157**  
**19 12 000 5158**  
**09 00 000 5157**  
**09 00 000 5158**

Pg 16  
M 25  
M 25  
Pg 21  
Pg 21

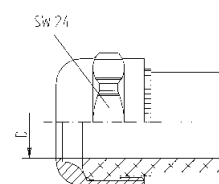

	cable	
	min.	max.
<b>09 00 000 5059</b>	11.5 mm	15.5 mm
<b>19 12 000 5157</b>	10.5 mm	14 mm
<b>19 12 000 5158</b>	14 mm	17 mm
<b>09 00 000 5157</b>	14 mm	18 mm
<b>09 00 000 5158</b>	17 mm	20.5 mm



thermoplastic / metal

Identification

Part number

Drawing

Dimensions in mm

Housings

Housings,  
bulkhead mounting

Thermoplastic  
angled



**09 12 008 0902**

Pg 16

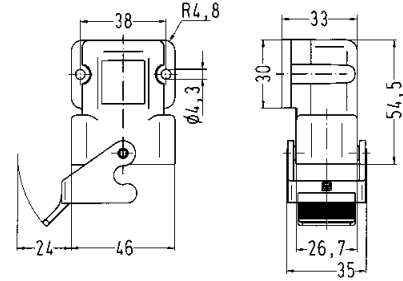

Housings,  
bulkhead mounting

Thermoplastic



**09 12 008 0327**

Pg 16

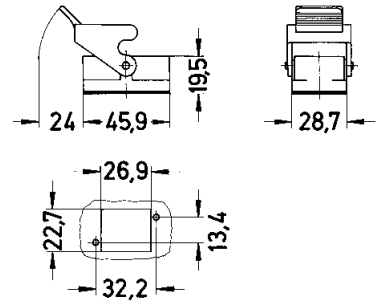

Gasket for housings  
bulkhead mounting

Han® Q 8/0



**09 12 000 9912**

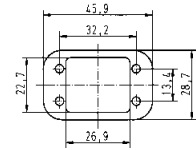

Housings,  
surface mounting

Thermoplastic  
angled  
Cable gland order separately



**09 12 008 0901**

Pg 16

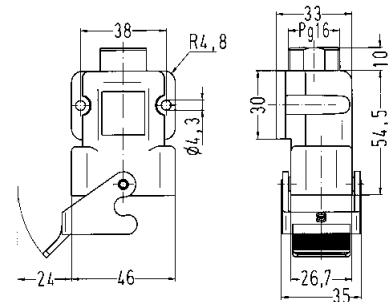

Hoods, cable to cable

Thermoplastic  
Cable gland order separately



**09 12 008 0727**  
**19 12 008 0729**

Pg 16  
M 25

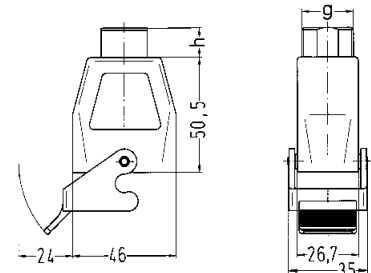

h	g
13	Pg 16
14	M 25x1.5

thermoplastic / metal

Identification

Part number

Drawing

Dimensions in mm

Housings

Cable seal

Thermoplastic  
for housings  
Thrust bolt and insert



09 00 000 5058

Pg 16

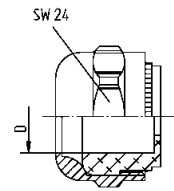

	cable	
	min.	max.
09 00 000 5058	11.5 mm	15.5 mm

Housings,  
bulkhead mounting

Metal



black  
chromated  
**09 12 008 0301**

black  
powder coated  
**09 12 708 0301**

matt  
nickel plated  
**09 12 008 0303**

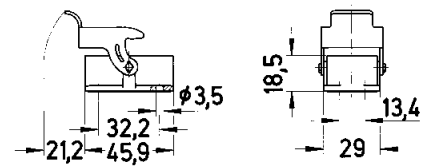

Han

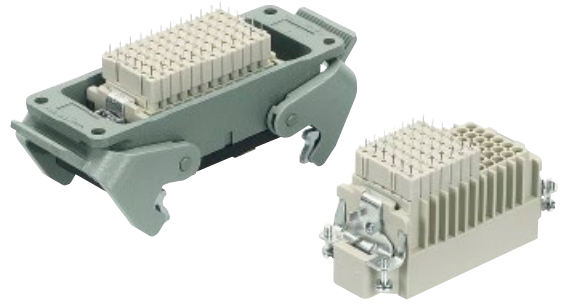

Han

Insert	Size	Part number		Drawing	Dimensions in mm															
		Male insert (M)	Female insert (F)																	
Order contacts separately					1) Distance for contact max. 21 mm <table border="1"> <thead> <tr> <th></th> <th>a</th> <th>b</th> </tr> </thead> <tbody> <tr> <td>24 DD</td> <td>44</td> <td>51</td> </tr> <tr> <td>42 DD</td> <td>57</td> <td>64</td> </tr> <tr> <td>72 DD</td> <td>77.5</td> <td>84.5</td> </tr> <tr> <td>108 DD</td> <td>104</td> <td>111</td> </tr> </tbody> </table>		a	b	24 DD	44	51	42 DD	57	64	72 DD	77.5	84.5	108 DD	104	111
	a	b																		
24 DD	44	51																		
42 DD	57	64																		
72 DD	77.5	84.5																		
108 DD	104	111																		
Han <sup>®</sup> 24 DD	6 B	<b>09 16 024 3001</b>	<b>09 16 024 3101</b>																	
Han <sup>®</sup> 42 DD	10 B	<b>09 16 042 3001</b>	<b>09 16 042 3101</b>																	
Han <sup>®</sup> 72 DD	16 B	<b>09 16 072 3001</b>	<b>09 16 072 3101</b>																	
Han <sup>®</sup> 108 DD	24 B	<b>09 16 108 3001</b>	<b>09 16 108 3101</b>																	

Han DD <sup>®</sup> double contacts	Part number		Drawing	Dimensions in mm
	Male contacts	Female contacts		
to connect the PCB-adapter				
	09 15 000 6191	<b>09 15 000 6291</b>		

Device side

PCB adapter	Part number		Drawing	Dimensions in mm						
	for PCBs up to 1.6 mm	for PCBs up to 2.4 mm								
				<table border="1"> <thead> <tr> <th></th> <th>a</th> </tr> </thead> <tbody> <tr> <td>09 16 000 9905</td> <td>2.6</td> </tr> <tr> <td>09 16 000 9908</td> <td>3.4</td> </tr> </tbody> </table>		a	09 16 000 9905	2.6	09 16 000 9908	3.4
	a									
09 16 000 9905	2.6									
09 16 000 9908	3.4									
		<b>09 16 000 9905</b>								
		<b>09 16 000 9908</b>								

Housing	Size	Part number		Drawing	Dimensions in mm																			
	6 B	<b>09 30 006 0301</b>		<table border="1"> <thead> <tr> <th>Size</th> <th>a</th> <th>b</th> <th>Panel cut out</th> </tr> </thead> <tbody> <tr> <td>6 B</td> <td>70</td> <td>80</td> <td>48 x 35</td> </tr> <tr> <td>10 B</td> <td>83</td> <td>93</td> <td>60 x 35</td> </tr> <tr> <td>16 B</td> <td>103</td> <td>113</td> <td>82 x 35</td> </tr> <tr> <td>24 B</td> <td>130</td> <td>140</td> <td>108 x 35</td> </tr> </tbody> </table>	Size	a	b	Panel cut out	6 B	70	80	48 x 35	10 B	83	93	60 x 35	16 B	103	113	82 x 35	24 B	130	140	108 x 35
	Size	a			b	Panel cut out																		
	6 B	70			80	48 x 35																		
	10 B	83			93	60 x 35																		
16 B	103	113	82 x 35																					
24 B	130	140	108 x 35																					
10 B	<b>09 30 010 0301</b>																							
16 B	<b>09 30 016 0301</b>																							
24 B	<b>09 30 024 0301</b>																							

Size 6 B with 1 locking lever

Cable side

## Features

- ❑ Robust design
- ❑ Suitable for standard and EMC housing
- ❑ Low wiring costs
- ❑ Higher contact density

## Technical characteristics

### Approvals



### Inserts

Number of contacts 24, 42, 72, 108

Electrical data acc. to DIN VDE 0627

**7.5 A 250 V 4 kV 3**

Working current  
Working voltage  
Rated impulse voltage  
Pollution degree

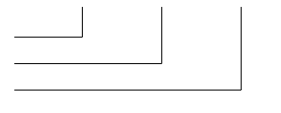

Working voltage acc. to UL

250 V

Testing voltage  $U_{rms}$   
Insulation resistance

2 kV  
 $\geq 10^{10} \Omega$

Material  
Limiting temperatures

Polyamide

Flammability acc. to UL 94

HB

Mechanical working life

- Mating cycles

$\geq 500$

Wire gauge

0.14 - 2.5 mm<sup>2</sup>

## Layout of printed circuit boards

Han<sup>®</sup> 24 DD

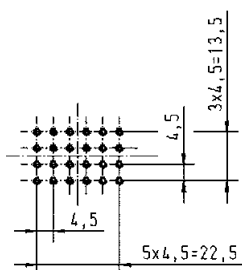

Han<sup>®</sup> 42 DD

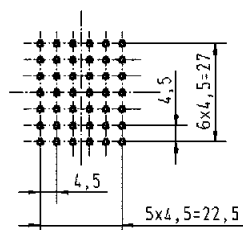

Han<sup>®</sup> 72 DD

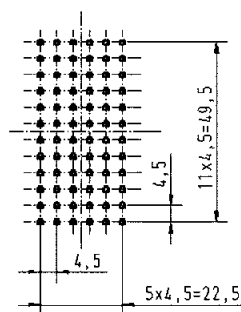

Han<sup>®</sup> 108 DD

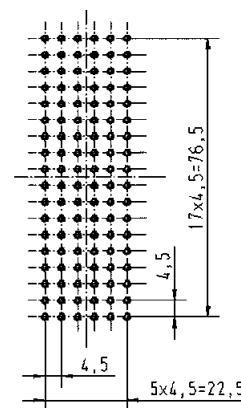

Recommended hole diameter: 0.8 mm

## Assembly situation

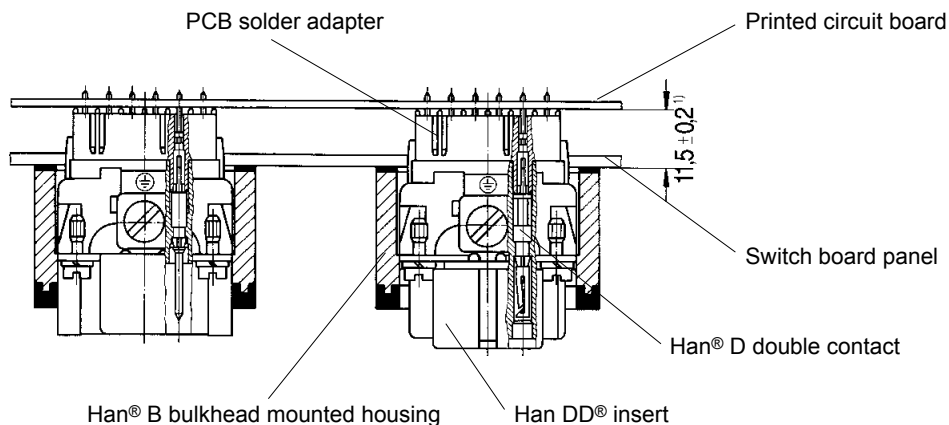

<sup>1)</sup> for Han<sup>®</sup> B EMC hoods/housings spacing of  $12.5 \pm 0.2$  is necessary as no flange seal is used.

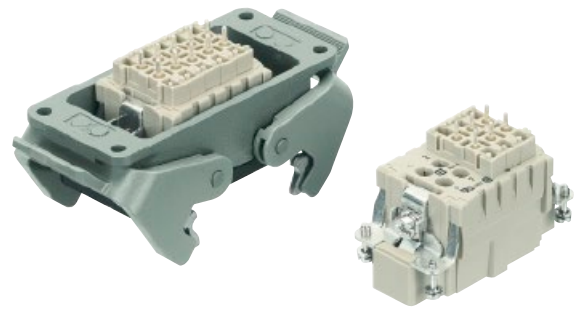

Han

Inserts	Size	Part number		Drawing	Dimensions in mm															
		Male insert (M)	Female insert (F)																	
Order contacts separately					<table border="1"> <thead> <tr> <th></th> <th>a</th> <th>b</th> </tr> </thead> <tbody> <tr> <td>6 E</td> <td>44</td> <td>51</td> </tr> <tr> <td>10 E</td> <td>57</td> <td>64</td> </tr> <tr> <td>16 E</td> <td>77.5</td> <td>84.5</td> </tr> <tr> <td>24 E</td> <td>104</td> <td>111</td> </tr> </tbody> </table>		a	b	6 E	44	51	10 E	57	64	16 E	77.5	84.5	24 E	104	111
	a	b																		
6 E	44	51																		
10 E	57	64																		
16 E	77.5	84.5																		
24 E	104	111																		
Han <sup>®</sup> 6 E	6 B	<b>09 33 006 2602</b>	<b>09 33 006 2702</b>																	
Han <sup>®</sup> 10 E	10 B	<b>09 33 010 2602</b>	<b>09 33 010 2702</b>																	
Han <sup>®</sup> 16 E	16 B	<b>09 33 016 2602</b>	<b>09 33 016 2702</b>																	
Han <sup>®</sup> 24 E	24 B	<b>09 33 024 2602</b>	<b>09 33 024 2702</b>																	

Han E <sup>®</sup> double contacts	Part number		Drawing	Dimensions in mm
	Male contacts	Female contacts		
to connect the PCB-adapter				
	09 33 000 6180	09 33 000 6280		

Device side

PCB adapter	Part number	Drawing	Dimensions in mm
	09 33 000 9996		

Housing	Size	Part number	Drawing	Dimensions in mm																				
	6 B 10 B 16 B 24 B	<b>09 30 006 0301</b> <b>09 30 010 0301</b> <b>09 30 016 0301</b> <b>09 30 024 0301</b>		<table border="1"> <thead> <tr> <th>Size</th> <th>a</th> <th>b</th> <th>Panel cut out</th> </tr> </thead> <tbody> <tr> <td>6 B</td> <td>70</td> <td>80</td> <td>48 x 35</td> </tr> <tr> <td>10 B</td> <td>83</td> <td>93</td> <td>60 x 35</td> </tr> <tr> <td>16 B</td> <td>103</td> <td>113</td> <td>82 x 35</td> </tr> <tr> <td>24 B</td> <td>130</td> <td>140</td> <td>108 x 35</td> </tr> </tbody> </table> <p>Size 6 B with 1 locking lever</p>	Size	a	b	Panel cut out	6 B	70	80	48 x 35	10 B	83	93	60 x 35	16 B	103	113	82 x 35	24 B	130	140	108 x 35
Size	a	b	Panel cut out																					
6 B	70	80	48 x 35																					
10 B	83	93	60 x 35																					
16 B	103	113	82 x 35																					
24 B	130	140	108 x 35																					

Cable side

Further informations see HARTING catalogue "Industrial Connectors Han<sup>®</sup>, chapter E"

## Features

- ❑ Robust design
- ❑ Suitable for standard and EMC housings
- ❑ Low wiring costs
- ❑ Counter connector available with screw, crimp or cage clamp termination

## Technical characteristics

### Inserts

Number of contacts	6, 10, 16, 24
Electrical data acc. to DIN EN 61984	<b>16 A 500 V 6 kV 3</b>
Working current	
Working voltage	
Rated impulse voltage	
Pollution degree	
Insulation resistance	$\geq 10^{10} \Omega$
Material	Polycarbonate
Limiting temperatures	-40 °C / +125 °C
Flammability acc. to UL 94	V0
Mechanical working life	
- Mating cycles	$\geq 500$
Wire gauge	0.5 - 4 mm <sup>2</sup>

## Layout of printed circuit boards

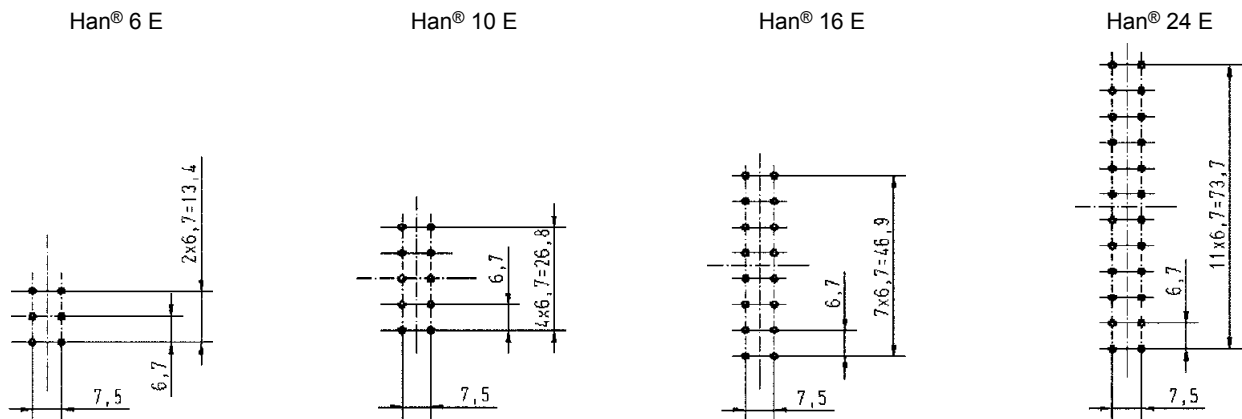

Recommended hole diameter: 1.8 mm

## Assembly situation

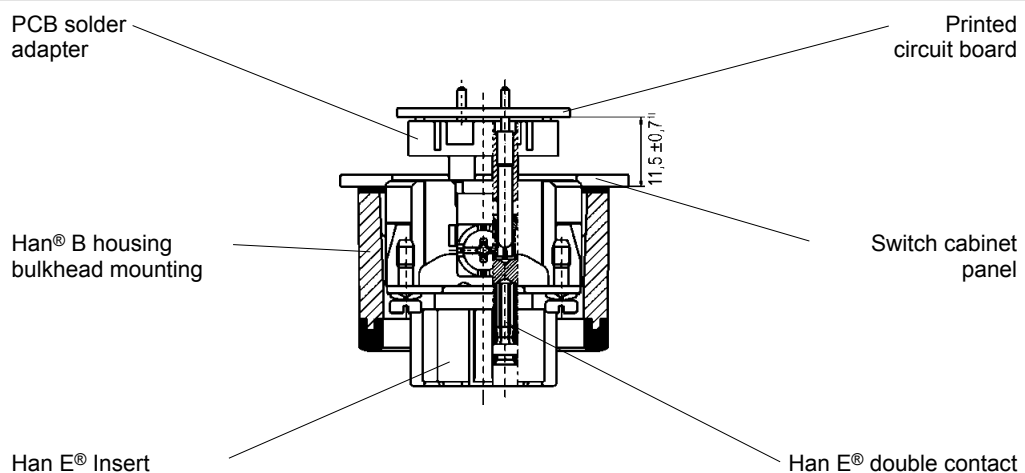

<sup>1)</sup> for Han<sup>®</sup> B EMC hoods/housings spacing of  $12.5 \pm 0.7$  is necessary as no flange seal is used





## Features

- ❑ Modular assembly
- ❑ Robust design
- ❑ Suitable for standard and EMC housings
- ❑ Low wiring costs

## Technical characteristics

### Han DD® module with PCB-adapter

Number of contacts	12
Working current	7.5 A
Working voltage	250 V
Wire gauge	0.14 - 2.5 mm <sup>2</sup>

### Han® axial screw module for PCB adaptations

Number of contacts	2
Working current	40 A
Working voltage	500 V
Wire gauge	2.5 - 10 mm <sup>2</sup>

## Layout of printed circuit boards

Depiction

Recommended hole diameter: 0.8 mm

Recommended hole diameter: 3.2 mm

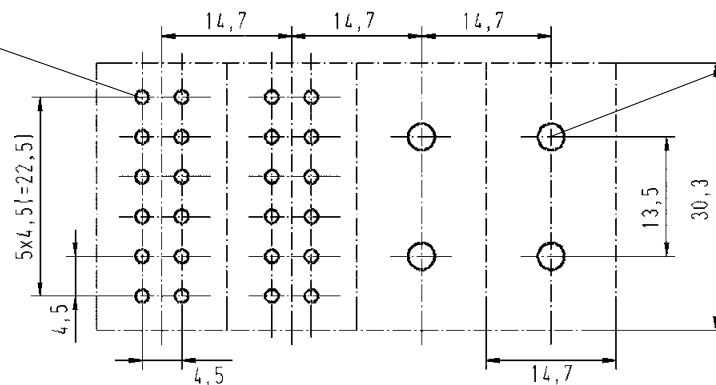

Han DD® module

Han® axial screw module 40 A

## Assembly situation

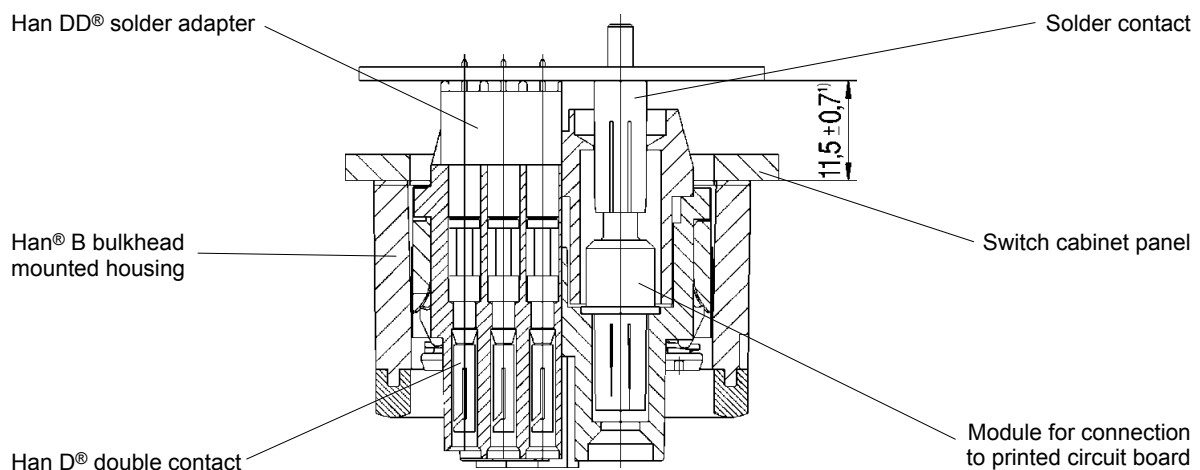

<sup>1)</sup> for Han® B EMC hoods/housings spacing of 12.5 ± 0.7 is necessary as no flange seal is used

- Secondary mating between industrial connector and printed circuit board.
- No higher force is applied on the soldering joint when mating the industrial connector due to an additional mating point.
- No wiring between printed circuit board and industrial connector necessary.
- thus no wiring faults  
⇒ no testing, no costs
- Connecting times are minimized.
- Easy handling is time and cost saving.
- The production of mechanical and electrical / electronical components can be completely separated.
- Possibility to reach a higher degree of automation in the production (i. e. wave soldering of the PCBs).

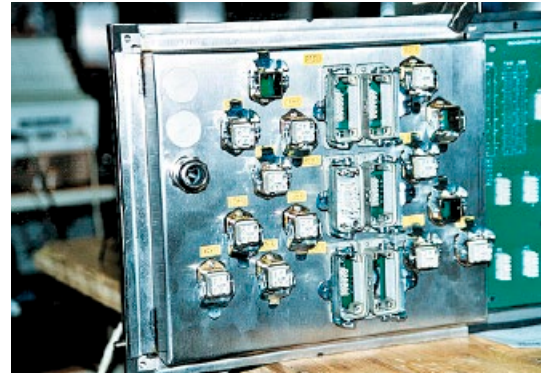

Han DD® and Han® Q 5/0 PCB-adapter  
Wilhelm Fette GmbH, Germany

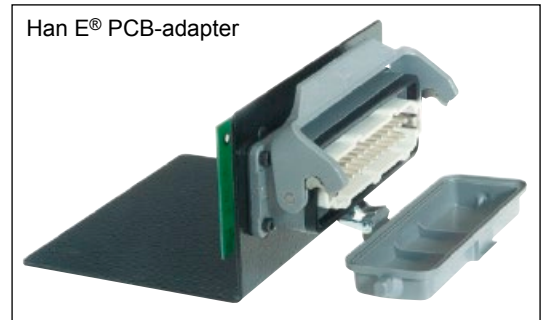

Han E® PCB-adapter

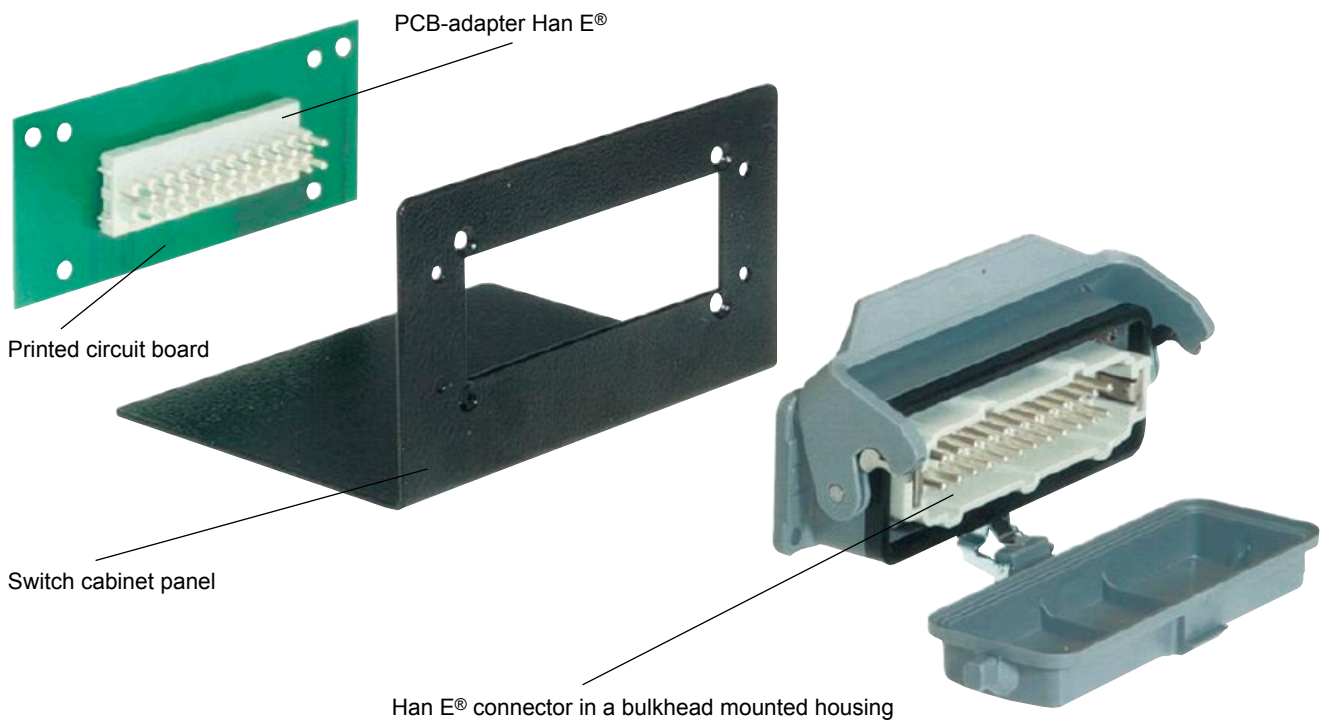

Han E® connector in a bulkhead mounted housing



## X-ON Electronics

Largest Supplier of Electrical and Electronic Components

*Click to view similar products for [Multi-Conductor Cables](#) category:*

*Click to view products by [HARTING](#) manufacturer:*

Other Similar products are found below :

[8916-GRY-100](#) [8917-BLK-100](#) [8917-GRN/YEL-100](#) [8918-GRN/YEL-100](#) [8920-BRN-1000](#) [8920-RED-1000](#) [89907-LT-DEC/GRY-500](#)  
[CR3909-000](#) [CR3927-000](#) [01342.35T.01](#) [01364.35T.01](#) [003201-000](#) [CS2885-000](#) [CS8782-000](#) [CS9912-000](#) [6200UE-NAT-U1000](#) [CTC-](#)  
[0062-20-9/5-9](#) [CTC-0062-22-9/5-9](#) [6304FE-877-U500](#) [6309UE-877-1000](#) [6320UE-NAT-U1000](#) [644833-000](#) [6502FE 8771000](#) [6504UE-877-](#)  
[U1000](#) [CW9530-000](#) [CX6543-000](#) [CXA-0066-20-4-9CS2973](#) [CXA-0078-16-1-9CS2405](#) [CXA-0078-22-4-9CS2405](#) [CXA-0078-24-4-](#)  
[9CS2405](#) [CXA-0140-16-6/9-9CS2405](#) [CY0660-000](#) [706/2R-BLACK-EACH](#) [720451-000](#) [730859-000](#) [MCC-USB-4-250](#) [752687-000](#)  
[768146-000](#) [773159-000](#) [7934A-BLK-1000](#) [8125-CHR-100](#) [8164-CHR-1000](#) [820457-000](#) [8205-CHR-1000](#) [8240-BLK-U1000](#) [82723-NAT-](#)  
[1000](#) [82907-NAT-500](#) [83003-YEL-500](#) [83005-WHT-500](#) [83006-DK-GRN-100](#)