

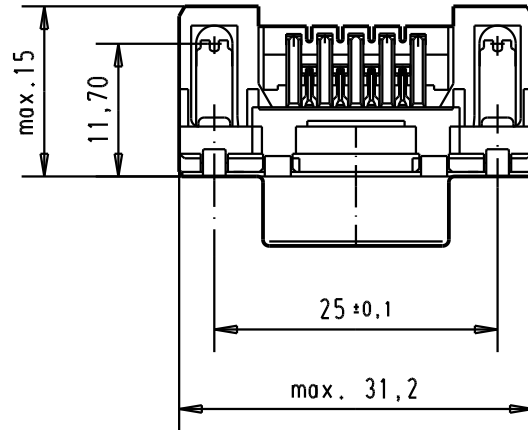

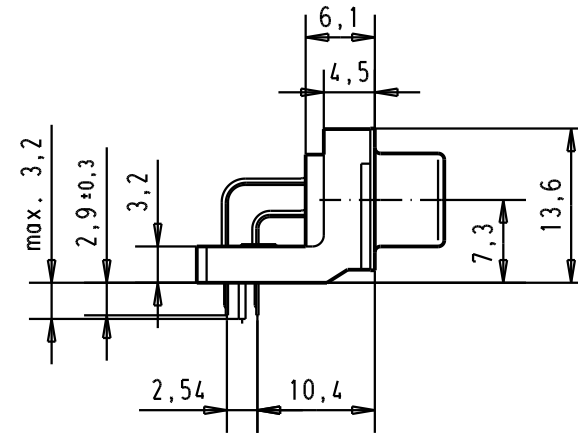

Mating face according to : MIL-C-24308 / DIN 41652 / CECC 75301-802

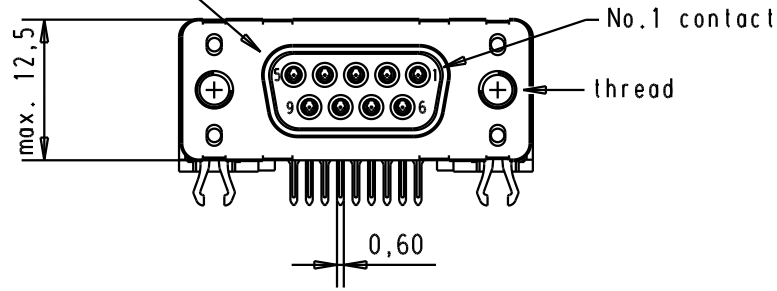
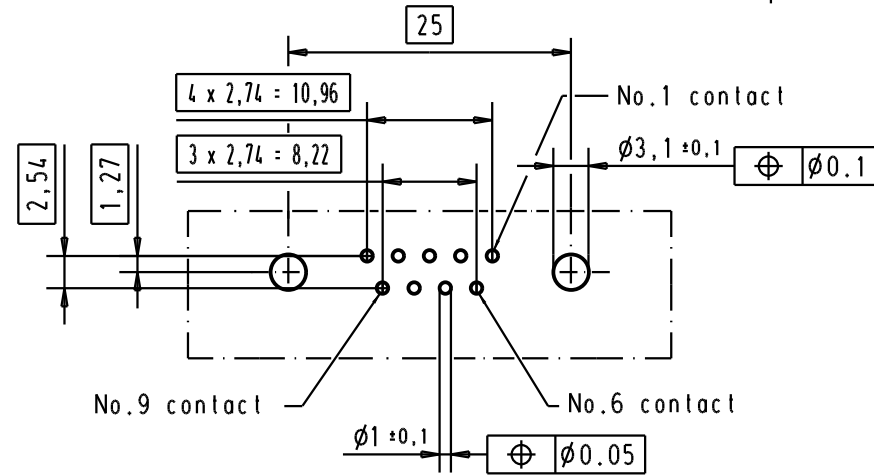

PCB layout hole component side

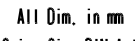

Connector retention and insertion forces on the PCB = 25 / 80 newtons

Part number	Nut thread	Performance level	Mod.	Dat.	Name	Dat.	Name	All Dim. in mm Orig. Size DIN A 4		Moßstab/ Scale
09 66 152 3611	M 3	1						 Detail. 20/nov/00 jfb	D-Sub 09 poles standard angle female, solder pin with nut and grounding board lock.	1.5:1
09 66 152 6611	M 3	2								
09 66 152 7611	M 3	3						 Insp.	<b>TB 0966152x61x</b>	Blatt/ Page 5 / 5
09 66 152 3612	4-40 UNC	1	31892	05/05/04	JH					
09 66 152 6612	4-40 UNC	2	31084	04/SEP/02	YT			Stand.		Sub.
09 66 152 7612	4-40 UNC	3	27957	20/nov/00	jfb					
HARTING EURL F-95972 Paris										

## X-ON Electronics

Largest Supplier of Electrical and Electronic Components

*Click to view similar products for [D-Sub Standard Connectors](#) category:*

*Click to view products by [HARTING](#) manufacturer:*

Other Similar products are found below :

[56F706-005-LI](#) [56F711-015](#) [LV242999-142T12](#) [015-0341-000](#) [015-0372-005](#) [015-0372-008](#) [015-8755-001](#) [020419-0104](#) [012-0467-000](#)  
[012-9507-034](#) [012-9507-114](#) [020745-0008](#) [609-25P](#) [CT2-18-11PCAU](#) [CT6-10SL-3SC](#) [CT6-10SL-4SC](#) [CT6-14S-2SC](#) [CT6E14SA7SC](#)  
[CT6N10SL-4SSA34](#) [M83513/01-FC](#) [M83723/76W24619 L/C](#) [M85049/48-3-2F](#) [6STD09PCM99B70X](#) [6STD09SCM99B30X](#)  
[6STD09SCT99S40X](#) [6STD15PCT99S40X](#) [6STD15SCT99S40X](#) [6STF09PCM05B70X](#) [7-135760-9](#) [MC11E-10-6SN](#) [747552-3](#) [MD1-21PS](#)  
[MDM-15SCBRM7-F222](#) [MDM96517-699](#) [MDM96521-744](#) [MDVB1-21SL1](#) [MIK0-1-7SH003](#) [MIKQ6-7SH076](#) [MIKQ7-7PH077](#) [MIKQ7-](#)  
[7PH11](#) [MIKQ7-7PH32](#) [MJSV-28SL61](#) [MKJ4A1F14-55S](#) [8-135760-3](#) [8STD09PCM99B30X](#) [PG-KV/PV-16-GROM-SEALING](#) [GDA15P](#)  
[GDAY15PB](#) [980-0000-170](#) [980-0000-171](#)