

5

4

3

2

1

Hood lower part

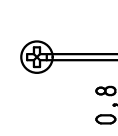
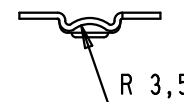
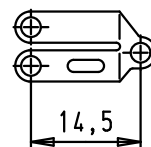
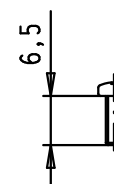
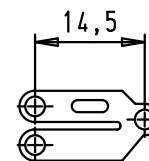
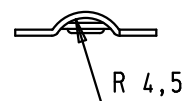
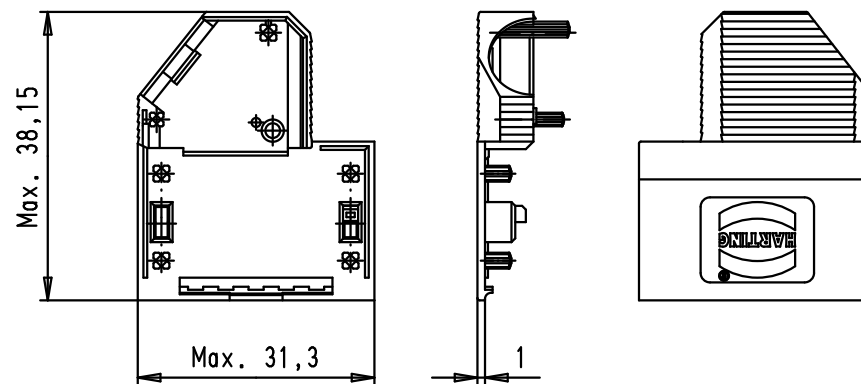
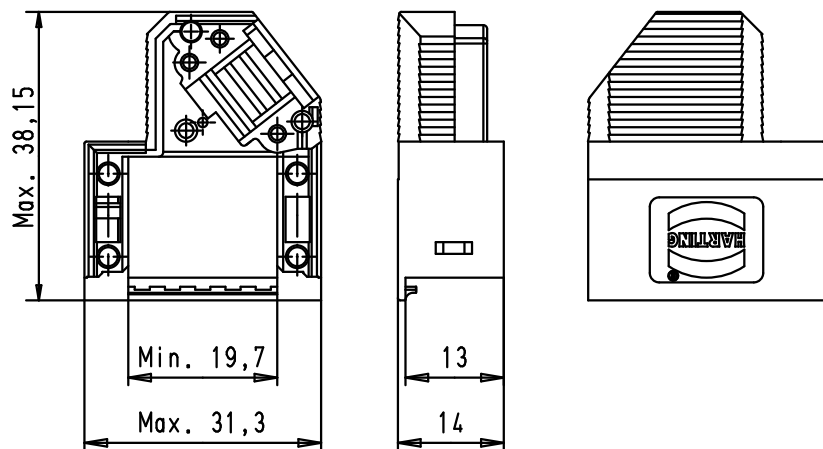

Hood upper part



Strain relief 1

Strain relief 2

Flathead screws

				Dot.	Name	 All Dim. in mm Orig. Size DIN A 4	D-Sub hoods 09 poles not shielded	Maßstab/ Scale 1:1
			Detail.	27/02/03	SH			
			Insp.					
			Stand.					
EC01696	19/04/10	SC	HARTING EURL F-95972 Paris				TB 09 67 009 0571	Blatt/ Page 1 / 1
34793	11/01/08	PK						
31392	27/02/03	SH						
Mod.	Dot.	Name					Sub.	

X-ON Electronics

Largest Supplier of Electrical and Electronic Components

Click to view similar products for [D-Sub Backshells](#) category:

Click to view products by [HARTING](#) manufacturer:

Other Similar products are found below :

[600X51137X](#) [600X54009X](#) [66241-12A](#) [M85049/6-38N](#) [M85049/86-12N03](#) [M85049/90-13P03](#) [70.350.0636.4](#) [70.350.2435.1](#) [72.350.1035.2](#)
[72.352.2435.1](#) [73.359.4035.3](#) [829472-1](#) [PCS-E20W](#) [970-015-040R011](#) [971-009-030R121](#) [971-009-040R011](#) [971-015-040R011](#) [DPH-B-003](#)
[1437013-9](#) [1484402-8](#) [156-3025-EX](#) [16-500800](#) [165X02659X](#) [165X03399A](#) [165X10259X](#) [165X11359X](#) [165X11759X](#) [165X11889X](#)
[165X11899X](#) [165X13019X](#) [165X13029X](#) [165X13169X](#) [165X13199X](#) [165X13239X](#) [165X13389X](#) [165X13489X](#) [165X14219X](#)
[165X14429X](#) [165X14449X](#) [165X17409X](#) [165X17439X](#) [165X17569X](#) [165X17599X](#) [165X17609X](#) [165X17979X](#) [L171373](#) [971-025-](#)
[030R121](#) [300X10989X](#) [165X02609X](#) [165X02639X](#)