

Alle Rechte vorbehalten/ All rights reserved

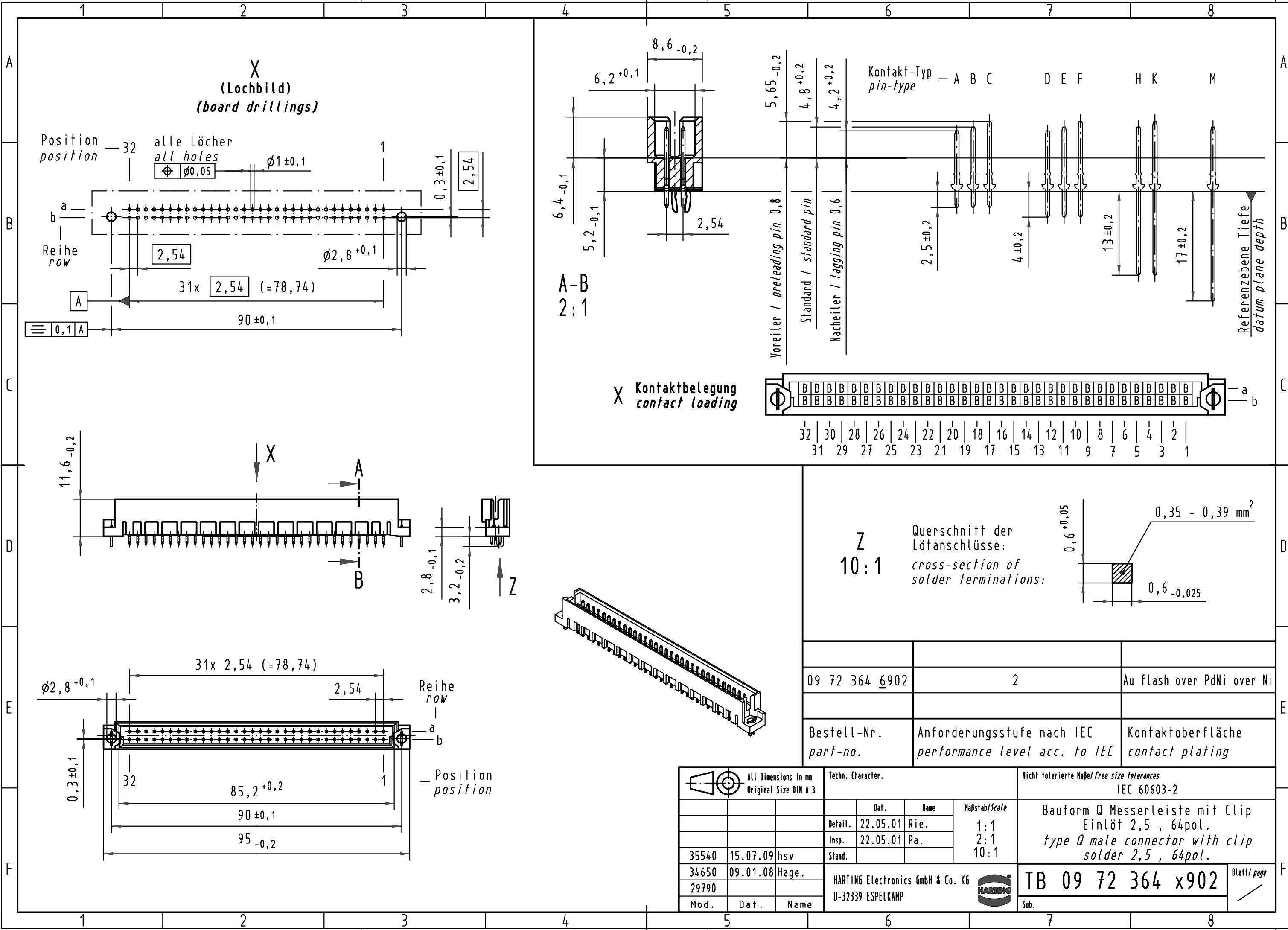

X
(Lochbild)
(board drillings)

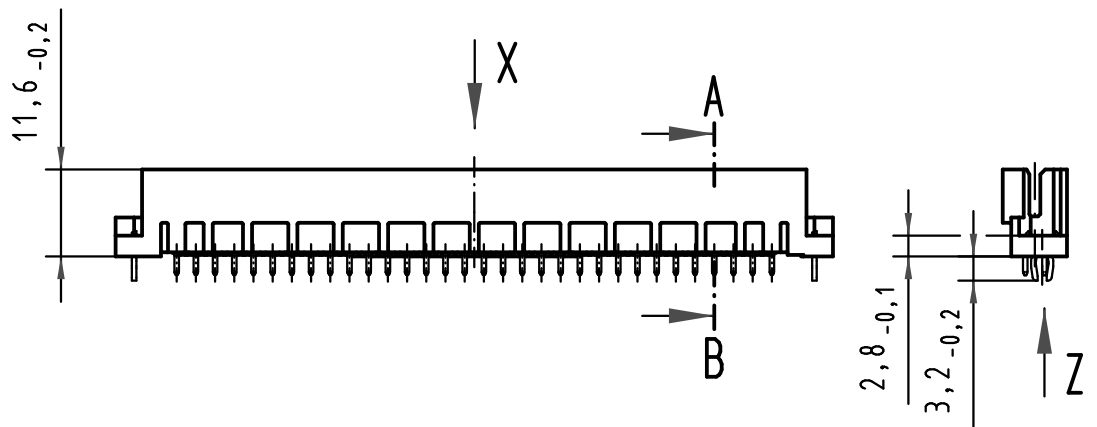
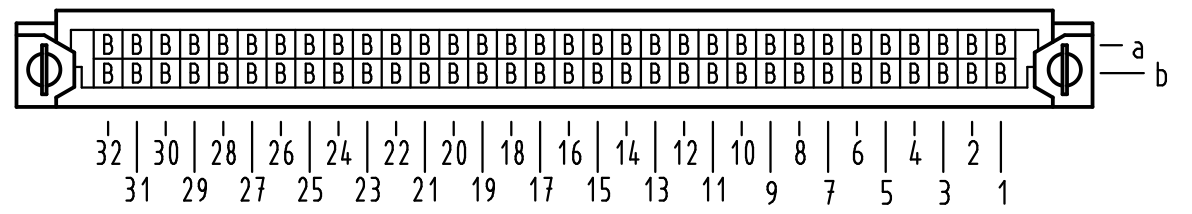
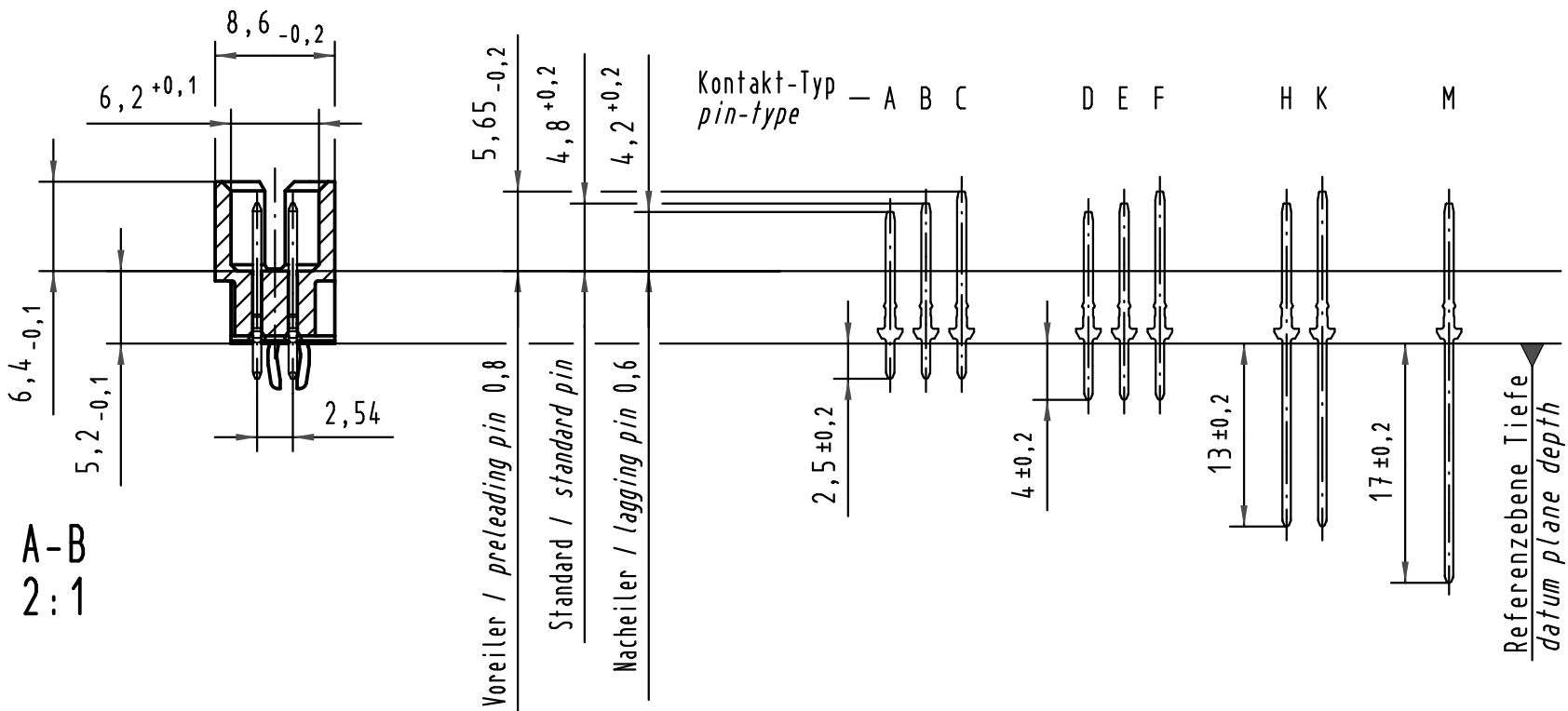
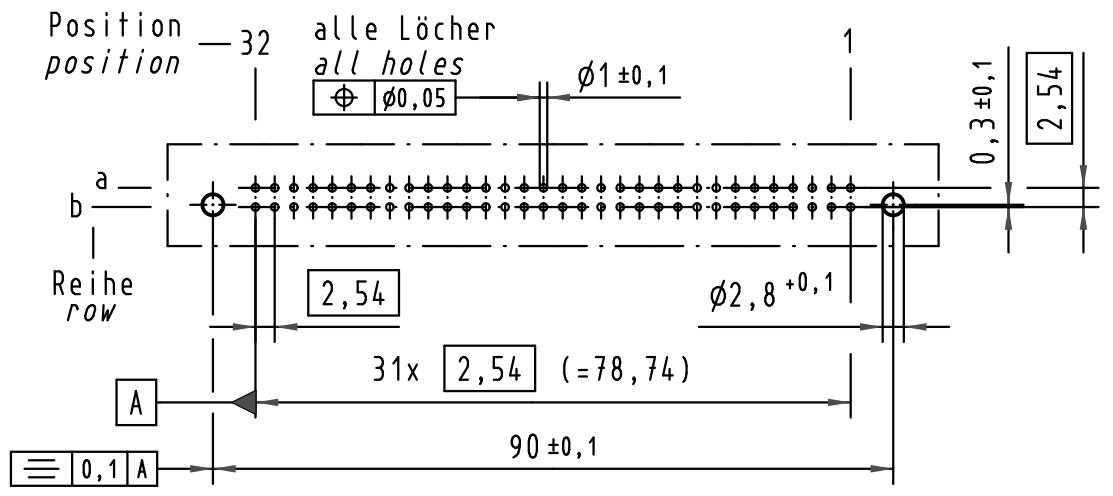

Z
10:1

Querschnitt der Lötanschlüsse:
cross-section of solder terminations:

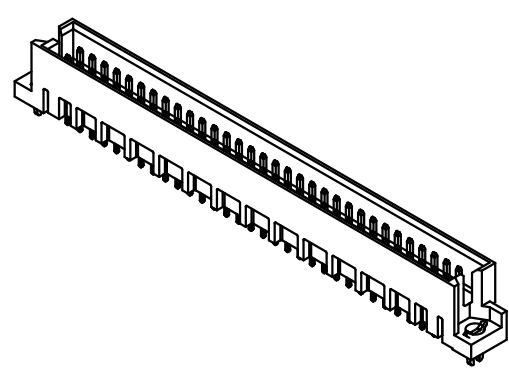
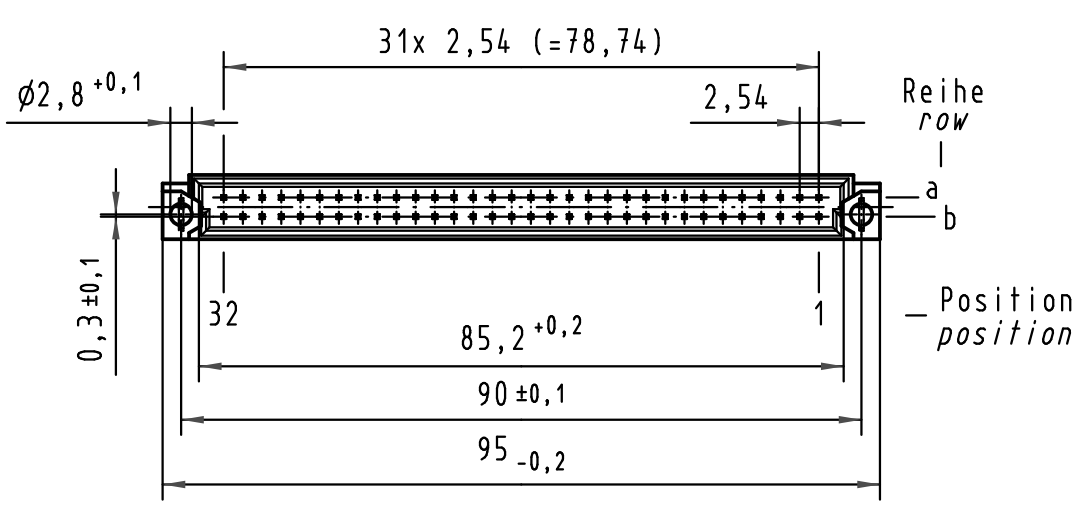
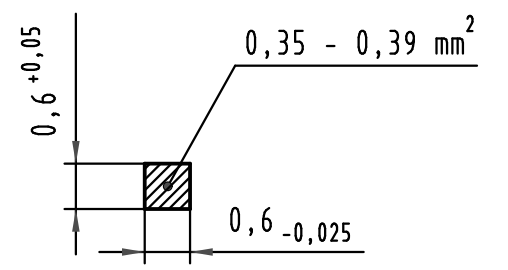

09 72 364 6902	2	Au flash over PdNi over Ni
Bestell-Nr. part-no.	Anforderungsstufe nach IEC performance level acc. to IEC	Kontaktoberfläche contact plating

All Dimensions in mm Original Size DIN A 3		Techn. Character.			Nicht tolerierte Maßel Free size tolerances IEC 60603-2		
		Dat.	Name	Maßstab/Scale	Bauform Q Messerleiste mit Clip Einlöt 2,5 , 64pol. type Q male connector with clip solder 2,5 , 64pol.		
		Detail.	22.05.01 Rie.				1:1
		Insp.	22.05.01 Pa.				
35540	15.07.09	hsv	Stand.	10:1			
34650	09.01.08	Hage.					
29790							
Mod.	Dat.	Name	HARTING Electronics GmbH & Co. KG D-32339 ESPELKAMP		TB 09 72 364 x902		
					Sub.	Blatt/ page	

X-ON Electronics

Largest Supplier of Electrical and Electronic Components

Click to view similar products for [DIN 41612 Connectors](#) category:

Click to view products by [HARTING](#) manufacturer:

Other Similar products are found below :

[09231126901](#) [PCN10F-24P-2.54DS\(72\)](#) [004.767](#) [02221602702](#) [024069](#) [602427301412000](#) [013275](#) [691327-1](#) [74670-0732](#) [74680-0340](#)
[75880-0015](#) [76453-0014](#) [86093159ALF](#) [923454](#) [QLC260R](#) [120X10099X](#) [120X10019X](#) [120X10089X](#) [120X10129X](#) [121A10039X](#)
[121A10309X](#) [122A10019X](#) [122A10029X](#) [122A10249X](#) [122A10669X](#) [122A11089X](#) [122A13089X](#) [121B10409X](#) [122A10089X](#)
[122A10129X](#) [122A10349X](#) [122A13359X](#) [1377391-4](#) [DIN-048CPC-SR1-MH](#) [1393583-2](#) [1393726-7](#) [140X10059X](#) [140X10129X](#) [143-1913-](#)
[000](#) [143-1908-000](#) [1484472-1](#) [173052](#) [2110070-1](#) [2110070-2](#) [CBC20T00-008FDS5-0-1-002VR](#) [983-0SE12-12P6](#) [17041102202](#) [172699-](#)
[5036](#) [173051](#) [20](#) [8457096](#) [010](#) [025](#)