

A distributed automation system does not contain any central automated control cabinets. Controls, sensors and actuators are designed for a high degree of protection (IP 65 / IP 67) and are installed directly in the field. In connection with these innovative installation concepts with distributed devices, users are demanding a standard connector family that is compatible with all interfaces. In response to these needs, the HARTING PushPull series has set the respective new appliance connection standard. PushPull technology is available for data, signal and power applications. Other interfaces accommodating USB or fiber optics (LC, SCRJ) supplement the universal range of the PushPull solutions. The integration of communication and power lines in a hybrid PushPull connector is a genuine trend-setting advance. In view of these strengths, the PushPull container has become the standard for current and future appliance interfaces. The German automotive industry, for example, has opted for the implementation of the PushPull connector family.

Application profile:

CONNECTION TYPE		ENVIRONMENT		APPLICATION						
Board to Board	Cable/Wire to Board	IP 20	IP 65 / IP 67	Data	Signal	Power	high performance			
							Data transfer rate	Shielding	Number of contacts, contact density	Voltage, working current
Cable termination			PCB termination			Application standard				
<i>Han-Quick Lock®</i>	<i>IDC HARAX®</i>	<i>Crimp</i>	<i>THT</i>	<i>SMC</i>	<i>SMT</i>					
<i>Screw</i>	<i>Cage clamp</i>	<i>Axial screw</i>	<i>Press-in</i>			Housing integration				
						<i>Separate housing</i>	<i>Integrated housing</i>			

1) Piercing contacts

CONTENTS	PAGE
Introduction PushPull termination technology	02.02
HARTING PushPull type acc. to IEC 61 076-3-106 variant 4	
HARTING PushPull – housing bulkhead mounting for device integration	02.04
HARTING PushPull RJ45	02.05
HARTING PushPull LC duplex	02.09
HARTING PushPull Hybrid	02.15
HARTING PushPull Signal	02.19
HARTING PushPull USB	02.21
HARTING PushPull Power, 4-poles, 48 V (12 A)	02.24
HARTING PushPull Power, 3-poles, 250 V (16 A)	02.27
HARTING PushPull Power – Tooling and accessories	02.28
Han® PushPull type acc. to IEC 61 076-3-117 variant 14	
Han® PushPull RJ45	02.31
Han® PushPull SCRJ and tooling	02.45
Han® PushPull Signal	02.52
Han® PushPull Power 4/0, 5-poles, 230/400 V (16 A)	02.55
Han® PushPull Power 4/0 – Contacts and tooling	02.61
Han® PushPull Power L 4/0, 5-poles, 24 V (16 A)	02.63

The PushPull connector housing is a function container with degree of protection IP 65 / IP 67 and is available in two standardized housing sizes. These containers are equipped with standard RJ45, FOC or power contacts for operation at 5 x 16 A, depending on application requirements. The PushPull connector can be delivered either as plastic, or as metal variant, depending on the installation environment.

THE PushPull PRINCIPLE

PushPull connector applications combine two basic advantages:

1. Simple operation
2. Safe and vibration resistant sealed IP 65 / IP 67 connection.

The innovative PushPull lock mechanism dispenses with the need for a latching bracket. The connector can be inserted with one hand, minimum force and an audible click for safe operation. The connection can be removed again just as easily for service work.

COPPER, FOC AND POWER – IN THE SAME DESIGN

HARTING offers two series of the PushPull connector system, which differ in terms of their outer dimensions and module inserts.

Han® PushPull (IEC 61 076-3-117 VARIANT 14)

This series represents the standard PROFINET device interface for the IP 67 environment of the German automobile manufacturing industry.

The connector is available as metal and as plastic version. The RJ45 module for copper conductors and the SCRJ module for FOCs are available as data connectors. The RJ45 variant is realized by means of the RJ Industrial module equipped with HARAX® quick connection technology. The power module which is installed in the same container can be assembled on-site, either with crimp contacts or with innovative Quick Lock® technology in order to wire the distributed field devices to 230/400 V (16 A) power. This 5-pole connector enables the transfer of two



independent 24 V control circuits with functional ground, or the transfer of a three-phase voltage of 400 V (16 A).

HARTING PushPull (IEC 61 076-3-106 VARIANT 4)

This extremely compact and space-saving series provides an Ethernet appliance connection with degree of protection IP 65 / IP 67 that requires no more installation space than a M12 connector. The RJ45 variant for copper conductors and the LC variant for FOCs are available as modules for data connectors. The RJ45 variant is realized by means of *HARAX*® quick connection technology as used with HARTING RJ Industrial®. The 4-pole module for 48 V (12 A) or the 3-pole module for 250 V (16 A) can be used to supply power to the distributed field devices.

HARTING PushPull HYBRID

The migration from Fieldbus to Ethernet within communication technology has simplified machine installation options. This

simplification is attained by combining the data and the 24 V power lines in a single hybrid cable with hybrid connector, in connection with the spatial requirements of an M12 connector.

The HARTING PushPull Hybrid offers trend-setting connection technology for this new method of machine installation.

The PushPull Hybrid reduces everything by half: the number of connection points and cables, and spatial requirements for the connection technology.

The PushPull Hybrid makes everything easier: machine installation, the wiring of connectors and safe insertion.

APPLIANCE INTEGRATION:

In order to support the implementation of appliances with degree of protection IP 65 / IP 67, HARTING offers panel feed-through devices with integrated couplings and female contact modules for direct mounting on PCBs.

PushPull

HARTING PushPull

ONE CONCEPT FOR DATA, SIGNAL AND POWER

The internationally standardized PushPull connector represents the latest generation of appliance connection technology with high degree of protection IP 65 / IP 67, easy insertion and snap-action engagement with audible click.

The PushPull housing family is designed for the integration of a wide range of contact inserts for data, signal and power lines.

INSTALLATION IN PLANTS

WITH Han® PushPull CONNECTORS:

- The standard for PROFINET communication
- One housing for the electrical and optical data transfer and for power supply
- Plastic or metal housing variants

INSTALLATION IN MACHINES

WITH HARTING PushPull HYBRID CONNECTORS:

- Combined data lines and appliance power supply up to 5 A in the same connector
- Compact size (comparable with M12)
- Straight and angled connector design, suitable for on-site assembly and overmolded

POWER SUPPLY TO DISTRIBUTED DEVICES

USING PushPull CONNECTORS:

- Variant 4: 48 V (12 A), 4-pole or 250 V (16 A), 3-pole
- Variant 14: 400 V (12 A) 5-pole, or 24 V (16 A) 5-pole
- Latest connection technology QuickLock® for on-site assembly without special auxiliary tools





HARTING PushPull Technology acc. to IEC 61076-3-106 variant 4 housing bulkhead mounting for device integration of RJ45-, USB- and Power-jacks

Advantages

- PushPull housing bulkhead mounting with HARTING PushPull technology
- Compact, space-saving design for device integration of RJ45-, USB- or Power-pcb female

Housing bulkhead mounting EasyInstall

- for simple device integration round panel cut out

Housing bulkhead mounting Compact

- high packing density (spacing 27 x 21 mm)

Technical characteristics

Locking	PushPull Technology acc. to IEC 61 076-3-106 variant 4
Shielding	fully shielded, 360° shielding contact
Mating cycles	min. 750
Degree of protection	IP 65 / IP 67
Temperature range	-40 °C ... +70 °C
Housing material	Plastic, black Zinc die-cast, shining
Flammability acc. to UL 94	V0
	UL approval (E102079)

Identification	Part No.	Drawing	Dimensions in mm
Components device side			
Housing bulkhead mounting – EasyInstall with integrated seal board drillings for M3			
without fixing clip	09 45 545 0030 ¹⁾ 09 45 595 0030 ²⁾⁴⁾		
with fixing clip	09 45 545 0031 ³⁾ 09 45 595 0031 ³⁾⁴⁾		
with fixing clip, for all HIFF compatible modules	09 45 545 0032		
Housing bulkhead mounting – Compact Board drillings for M2.5			
without fixing clip (incl. flat seal)	09 45 545 0023 ²⁾		
without fixing clip (with integrated seal)	09 45 545 0033 ²⁾		
with fixing clip (incl. flat seal)	09 45 545 0021 ³⁾		
with fixing clip (with integrated seal)	09 45 545 0029 ³⁾		
with fixing clip (with integrated seal) for vertical RJ jack 09 45 551 1103	09 45 545 0027		
with fixing clip, for all HIFF compatible modules	09 45 545 0028		

1) suitable RJ45 jacks: 09 45 551 1100 / ... 1110 / ... 1102 / ... 1103 / ... 1130 / ... 1530

2) suitable RJ45 jacks: 09 45 551 1100 / ... 1110 / ... 1102 / ... 1130 / ... 1530

3) suitable RJ45 jacks: 09 45 551 1100 / ... 1110 / ... 1102

4) Metal version



HARTING PushPull Technology acc. to IEC 61 076-3-106 variant 4
RJ45 jacks and accessories

Advantages

- HARTING PushPull technology
- Low-profile jacks for space-saving PCB integration
- Category of transmission Cat. 5
- Suitable for PoE (IEEE 802.3af) and PoE+ (IEEE 802.3at)

Technical characteristics

Locking	PushPull Technology acc. to IEC 61 076-3-106 variant 4
Transmission rate	10/100/1000 Mbit/s
Shielding	fully shielded, 360° shielding contact
Mating cycles	min. 750
Degree of protection	IP 65 / IP 67
Temperature range	-40 °C ... +70 °C
Housing material	Plastic, black
Flammability acc. to UL 94	V0
	UL approval (E102079)

Identification

Part No.

Drawing

Dimensions in mm pcb layout

Components device side

RJ45 jacks Cat. 5

Solder variant SMD, 90° angled

09 45 551 1100¹⁾
09 45 551 1110²⁾

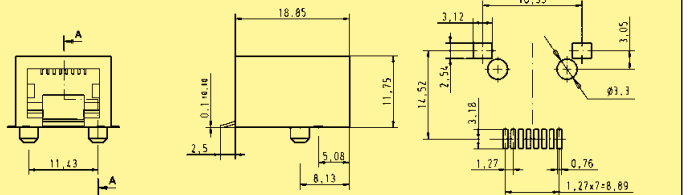

Solder variant overmolded, 90° angled

09 45 551 1102¹⁾

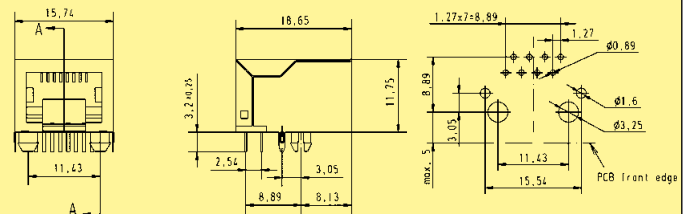

Solder variant overmolded, straight

09 45 551 1103³⁾

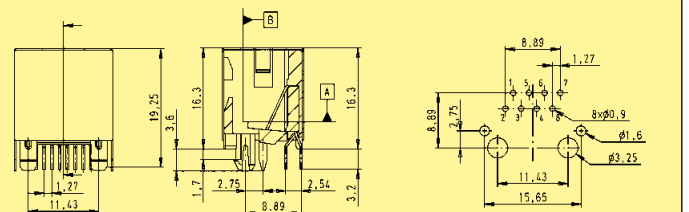

1) Packaging: Blister à 120 pieces
2) Packaging: Tape & Reel à 130 pieces
3) Packaging: Tape & Reel à 80 pieces

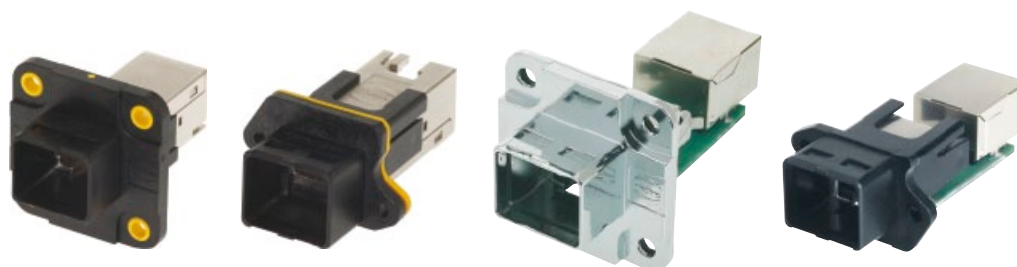

HARTING PushPull Technology acc. to IEC 61 076-3-106 variant 4
RJ45-panel feed-throughs and accessories

Advantages

- Small, space-saving PushPull Interfaces in IP 65 / IP 67
- Easy handling of RJ45 patch cords in switch cabinets or sets
- Mounting to casings

Technical characteristics

Locking	PushPull Technology acc. to IEC 61 076-3-106 variant 4
Transmission rate cat. 5 versions	10/100/1000 Mbit/s
Transmission rate cat. 6 versions	10/100 Mbit/s / 1/10 Gbit/s
Shielding	fully shielded, 360° shielding contact
Mating cycles	min. 750
Degree of protection	IP 65 / IP 67
Temperature range	-40 °C ... +70 °C
Housing material	Plastic, black Zinc die-cast, shining
Flammability acc. to UL 94	V0 UL approval (E102079)

Identification	Part No.	Drawing	Dimensions in mm
Panel feed-through set category of transmission Cat. 5 incl. housing bulkhead mounting EasyInstall with integrated seal, 2 x RJ45-jack board drillings for M3 incl. housing bulkhead mounting Compact, flat seal, 2 x RJ45-jack board drillings for M2.5	09 45 245 1130 09 45 295 1130 (metal version) 09 45 245 1102		
Panel feed-through set category of transmission Cat. 6 incl. housing bulkhead mounting EasyInstall with integrated seal, 2 x RJ45-jack board drillings for M3 incl. housing bulkhead mounting Compact, with integrated seal, 2 x RJ45-jack	09 45 245 1590 09 45 245 1560		

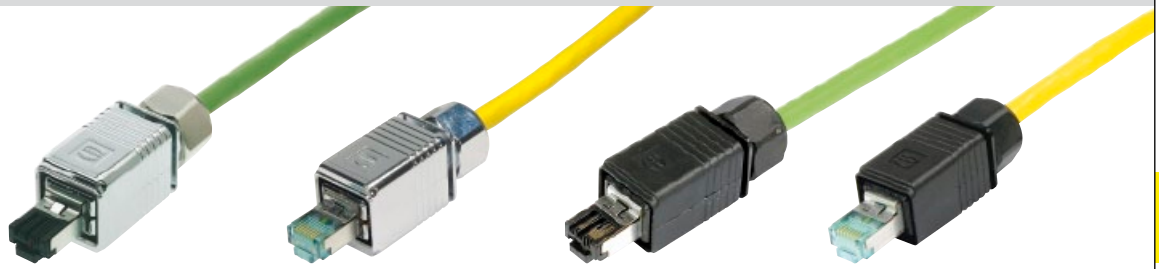

PushPull

HARTING PushPull Technology acc. to IEC 61 076-3-106 variant 4 RJ45-connector

Advantages

- Ethernet connector based on RJ45
- Fully shielded, 360° shielding contact
- Field-assembly connector with IDC contacts (Cat. 5 versions) or piercing contacts (Cat. 6_A versions)

Technical characteristics

Locking	PushPull Technology acc. to IEC 61 076-3-106 variant 4
Degree of protection	IP 65 / IP 67
Mating face	RJ45 acc. to IEC 60 603-7
Cable diameter	4.9 ... 8.6 mm
Termination cross section	
Cat. 5	AWG 24/7 ... AWG 22/7 (stranded) AWG 23/1 ... AWG 22/1 (solid)
Cat. 6 _A	AWG 24/7 ... AWG 28/7 (stranded)
Mating cycles	min. 750
Temperature range	-40 °C ... +70 °C
Housing material	Plastic, black Zinc die-cast, shining
Flammability acc. to UL 94	V0
	UL approval (E102079)

Identification

Part No.

Drawing

Dimensions in mm

Connector, 4-poles Cat. 5

incl. housing with RJ45 connector, shielding and cable gland

09 45 145 1100
09 45 195 1100
(metal version)

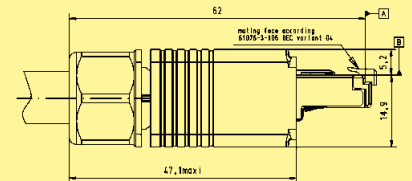
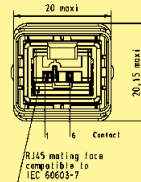

Connector, 8-poles Cat. 6_A

incl. housing with RJ45 connector, shielding and cable gland

09 45 145 1520
09 45 145 1520 XL¹⁾
09 45 195 1520
(metal version)

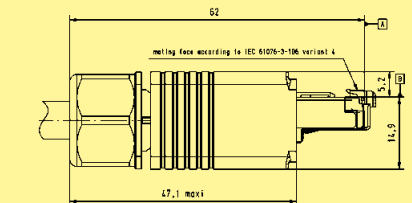
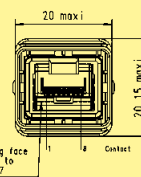

suitable assembly tool

09 45 800 0520

System cables in different versions

see catalogue "Intelligent Network Solutions"

Tools see page 01.16
1) Packaging with 100 sets

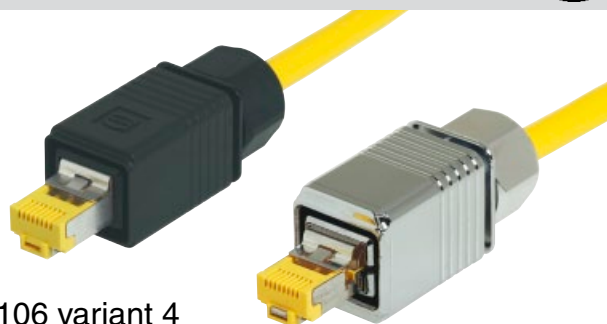

HARTING PushPull Technology acc. to IEC 61 076-3-106 variant 4 RJ45-connector

Advantages

- Ethernet connector based on RJ45
- Fully shielded, 360° shielding contact
- Field-assembly connector with IDC contacts
- Category of transmission: Cat. 6 / class E_A suitable for 1/10 Gbit Ethernet

Technical characteristics

Locking	PushPull Technology acc. to IEC 61 076-3-106 variant 4
Mating face	RJ45 acc. to IEC 60 603-7
Cable diameter	4.9 ... 8.6 mm
Termination cross section	AWG 27/7 ... AWG 22/7 (stranded) AWG 24/1 ... AWG 22/1 (solid)
Conductor diameter	max. 1.6 mm (incl. insulation)
Mating cycles	min. 750
Degree of protection	IP 65 / IP 67
Temperature range	-40 °C ... +70 °C
Housing material	Plastic, black Zinc die-cast, shining
Flammability acc. to UL 94	V0
	UL approval (E102079)

Identification	Part No.	Drawing	Dimensions in mm
----------------	----------	---------	------------------

Connector, 8-poles
Cat. 6

incl. housing with RJ45 connector, shielding and cable gland

09 45 145 1560
09 45 145 1560 XL¹⁾
09 45 195 1560
(metal version)

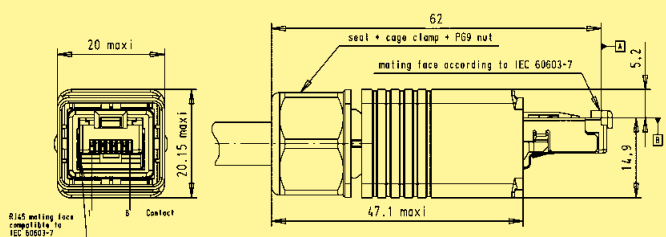

Colour clips

for colour coding the HARTING PushPull connectors

White	09 45 840 0011
Yellow	09 45 840 0013
Red	09 45 840 0017
Blue	09 45 840 0018
Green	09 45 840 0019

System cables in different versions

see catalogue "Intelligent Network Solutions"

¹⁾ Packaging with 100 sets

HARTING PushPull LC duplex



HARTING PushPull type acc. to IEC 61 076-3-106 variant 4
LC duplex panel feed-through and connector

PushPull

Advantages

- Optical PushPull connector based on LC with small form factor (requires 50 % compared to SC and ST)
- EasyInstall and Compact panel feed-through for simple device integration
- Optical module with inserts acc. to IEC 61 754-20
- One-piece LC body assures high mechanical stability
- A & B parts identification for Duplex according TIA 568 standard

Technical characteristics

Locking	PushPull Technology acc. to IEC 61 076-3-106 variant 4
Degree of protection	IP 65 / IP 67
Mating face	LC acc. to IEC 61 754-20
Cable diameter	5.8 ... 7.2 mm
Mating cycles	min. 200
Temperature range	-40 °C ... +70 °C
Housing material	Plastic, black Zinc die-cast, shining
Flammability acc. to UL 94	V0

Identification	Part No.	Drawing	Dimensions in mm
HARTING PushPull LC duplex			
Cable side			
Multimode GOF	09 57 402 0500 000		
(metal version)	09 57 409 0500 000		
Singlemode GOF	09 57 402 0501 000		
(metal version)	09 57 409 0501 000		
Device side EasyInstall version			
Multimode GOF	09 57 441 0500 000		
(metal version)	09 57 468 0500 000		
Singlemode GOF	09 57 441 0501 000		
(metal version)	09 57 468 0501 000		
Device side Compact version			
Multimode GOF	09 57 442 0502 001		
Singlemode GOF	09 57 442 0503 001		

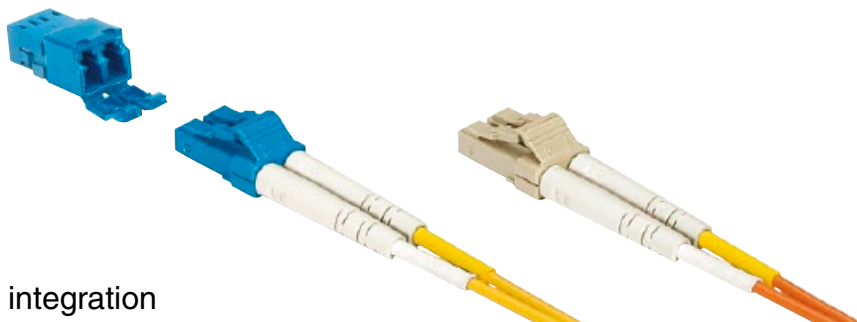

LC duplex IP 20 adapter for device integration

Advantages

- Small form factor requires 50 % (compared to SC and ST)
- Compact, space-saving design
- High packing density
- A & B parts identification according TIA 568 standard
- Complement adapter for IP 67 connector on device side

Technical characteristics

Degree of protection	IP 20
Mating interface	LC duplex with two fibres
Temperature range	-40 °C ... +70 °C

Identification

Part No.

Drawing

Dimensions in mm

Device side

Adapter

Multimode GOF

09 57 400 0003 000

Singlemode GOF

09 57 400 0004 000

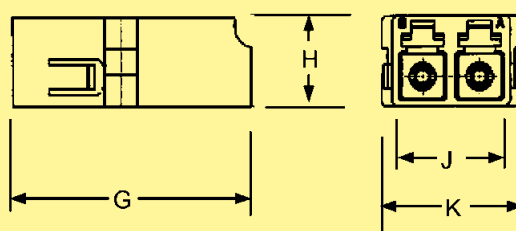

	min.	max.
G	26.60	26.80
H	9.35	9.45
J	12.80	12.90
K	15.24	15.34

Connector
LC duplex

Multimode GOF

09 57 400 0001 000

Singlemode GOF

09 57 400 0002 000

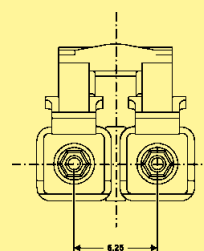
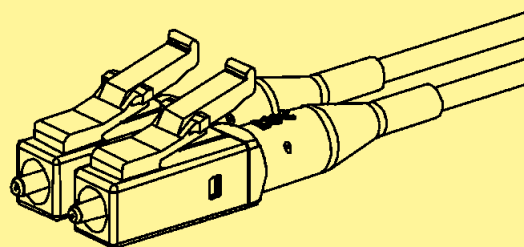



Identification	Part No.	Drawing	Dimensions in mm
----------------	----------	---------	------------------

Fibre optic cable, double ended, multi mode, 62.5 μ m overmolded

Length: a = 1 m	33 58 231 0010 016
a = 5 m	33 58 231 0050 016
a = 10 m	33 58 231 0100 016
a = 20 m	33 58 231 0200 016
a = 40 m	33 58 231 0400 016
a = 50 m	33 58 231 0500 016
a = 60 m	33 58 231 0600 016
a = 100 m	33 58 231 1000 016
a = 300 m	33 58 231 3000 016

double ended

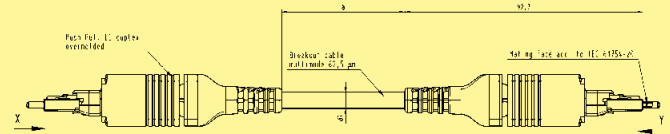

a = length

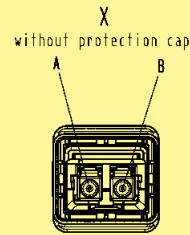

Loading-Plan

A — blue B
B — orange A

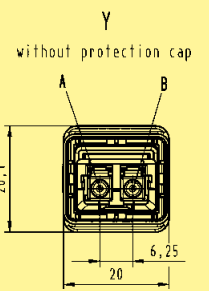

Fibre optic breakout cable, multi mode, 62.5 μ m

Length: 10 m	33 58 751 0100 001
Length: 20 m	33 58 751 0200 001
Length: 100 m	33 58 751 1000 001



PUR jacket

2-fibre multi mode 62.5 μ m

Outer diameter: 7 mm

Min. bending radius:

Installation: 10.5 cm

Operating: 7.0 cm



Identification	Part No.	Drawing	Dimensions in mm
----------------	----------	---------	------------------

Fibre optic cable, double ended, multi mode, 50 µm overmolded

Length: a = 1 m	33 58 231 0010 017
a = 5 m	33 58 231 0050 017
a = 10 m	33 58 231 0100 017
a = 20 m	33 58 231 0200 017
a = 40 m	33 58 231 0400 017
a = 50 m	33 58 231 0500 017
a = 60 m	33 58 231 0600 017
a = 100 m	33 58 231 1000 017
a = 300 m	33 58 231 3000 017

double ended

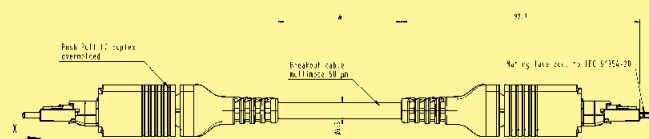

a = length

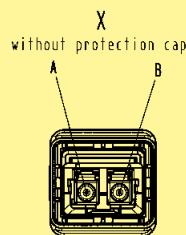

Loading-Plan

A — blue — B
B — orange — A

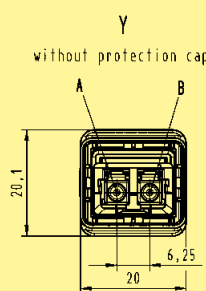

Fibre optic breakout cable, multi mode

Length: 10 m	33 58 751 0100 003
Length: 20 m	33 58 751 0200 003
Length: 100 m	33 58 751 1000 003



PUR jacket
 2-fibre multi mode 50 µm
 Outer diameter: 6.5 mm
 Min. bending radius:
 Installation: 10.4 cm
 Operating: 5.2 cm



Identification	Part No.	Drawing	Dimensions in mm
----------------	----------	---------	------------------

Fibre optic cable, double ended, single mode overmolded

Length: a = 1 m	33 58 231 0010 015
a = 5 m	33 58 231 0050 015
a = 10 m	33 58 231 0100 015
a = 20 m	33 58 231 0200 015
a = 40 m	33 58 231 0400 015
a = 50 m	33 58 231 0500 015
a = 60 m	33 58 231 0600 015
a = 100 m	33 58 231 1000 015
a = 300 m	33 58 231 3000 015

double ended

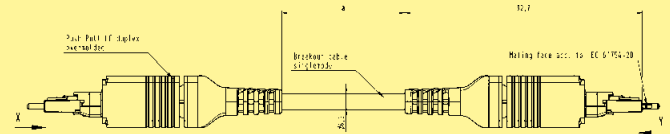

a = length

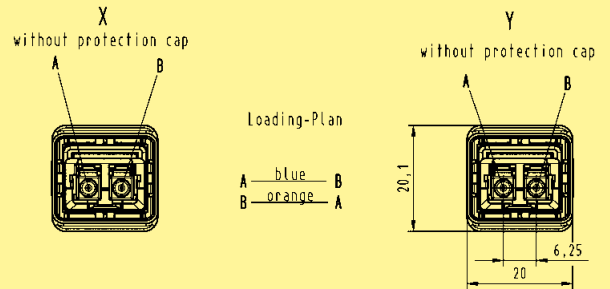

Fibre optic breakout cable, single mode

Length: 10 m	33 58 751 0100 002
Length: 20 m	33 58 751 0200 002
Length: 100 m	33 58 751 1000 002



PUR jacket
 2-fibre single mode
 Outer diameter: 6.5 mm
 Min. bending radius:
 Installation: 10.4 cm
 Operating: 5.2 cm

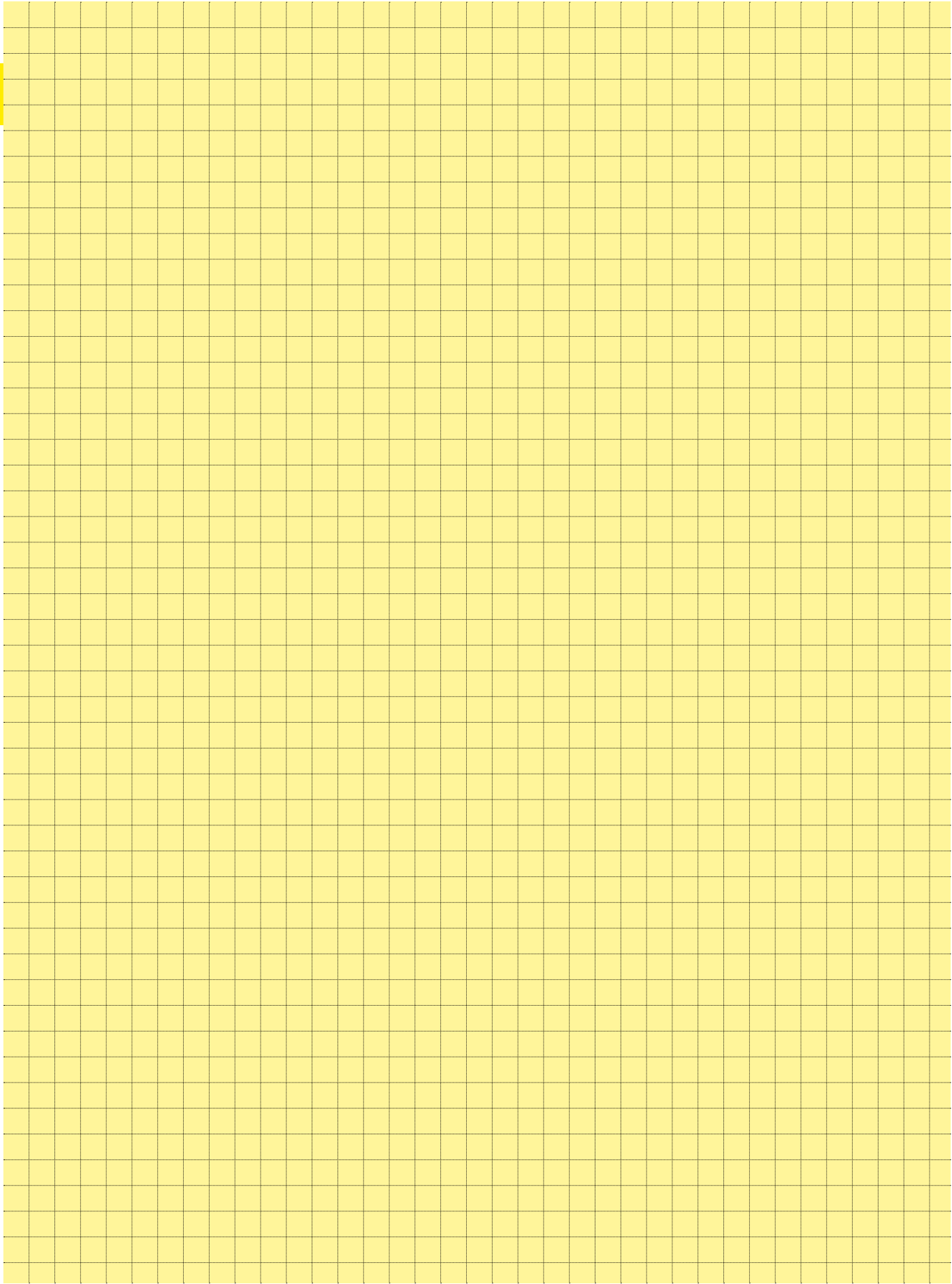



HARTING PushPull Hybrid
type acc. to IEC 61 076-3-106 variant 4

Advantages

HARTING PushPull Hybrid

In the future all new machine generations will be equipped with Fast Ethernet, no matter if PROFINET, Ethernet/IP, Powerlink, Ethercat, Varan or other Ethernet profiles.

With the change of the communication technology also the possibility is offered of simplifying the machine installation and of introducing an innovative Hybrid installation concept. This simplification will unite by data and 24 V (5 A)-supply in a Hybrid cable, at least with the space requirement of a M12-connector.

For this new installation solution HARTING with the HARTING PushPull Hybrid offers the trend-setting installation technology.

Everything is halved: the number of pluggings, the number of cables and the space requirement for the connection technology. Everything becomes simpler: the installation, attaching and safe plugging.

The Hybrid connectors were developed particular under the criteria of simple attaching in the field and the particular safe data communication with the patented omega screen concept. As contacts D-Sub and HDD Sub contacts worked world-wide are used. This socket pin contact system ensures highest reliability and optimal shock and vibration stability.

With the optional available coding pins 6 different codings can be realized.

This connector is available in the variants straight or angled as well as for field assembling or overmolded.

Technical characteristics

Advantages

- Compact, space-saving design
- Very compact housing with high degree of protection
- Polarisation with nose
- Sixfold codable

Typical application areas

- Factory and building automation
- Industrial electronics
- Telecommunication and wireless networks
- Transportation
- Industrial monitoring and camera systems
- Lighting and display technology
- Access control systems

Recommended pin assignment

- Power contacts

Contact	Function	Conductor colour
1	V +	Red
2	Ground	Brown
3	V + (switched)	Yellow

- Data contacts

Contact	Signal	Function	Conductor colour
4	RD -	Receiver Data -	Blue
5	RD +	Receiver Data +	White
6	TD -	Transmission Data -	Orange
7	TD +	Transmission Data +	Yellow



Structure Hybrid cable
Data: 4x AWG26/7
Power: 3x AWG20/7



HARTING PushPull Hybrid, type acc. to IEC 61 076-3-106 variant 4 device side

Advantages

- Combined data- and power-supply up to 5 A/48 V included to one connector
- HARTING PushPull technology
- Compact design
- High packing density
- Sixfold codable
- Suitable for all Fast-Ethernet variants

Technical characteristics

Locking	PushPull Technology acc. to IEC 61 076-3-106 variant 4
Degree of protection	IP 65 / IP 67
Termination	Solder pins
Transmission performance	Category 5 / Class D up to 100 MHz acc. to ISO/IEC 11 801:2002, EN ISO 50 173-1
Transmission rate	10 / 100 Mbit/s
Number of contacts	Data: 4, shielded (Ethernet) Power: 3, (5 A / 48 V)
Housing material	Plastic, black
Flammability acc. to UL 94	V0

Identification	Part No.	Drawing	Dimensions in mm
----------------	----------	---------	------------------

Components device side

Set straight

HARTING PushPull Hybrid housing bulkhead mounting and pcs female shielded, IP 65 / IP 67, black, 180° straight

09 45 245 1300

Set angled

HARTING PushPull Hybrid housing bulkhead mounting and pcs female shielded, IP 65 / IP 67, black, 90° angled

09 45 245 1310

Female insert

PCB jack shielded 180° straight

09 45 545 1300

PCB jack shielded 90° angled

09 45 545 1305

Housing bulkhead mounting

for female insert straight
for female insert angled

09 45 545 1320

09 45 545 1325

Panel feed-through

1 x Hybrid female IP 65 / IP 67 on
1 x RJ45 female and 3 pcb clamps,
board drillings for M2.5

09 45 245 1320

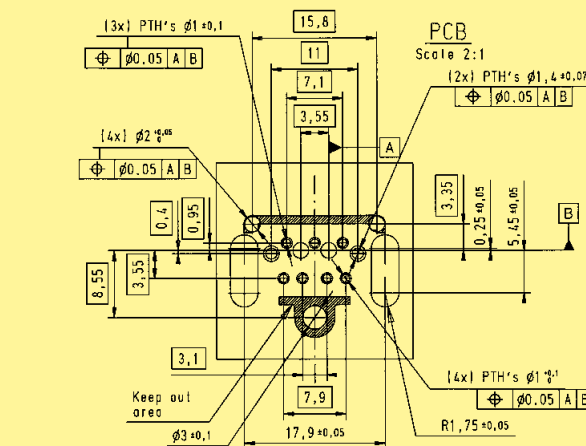
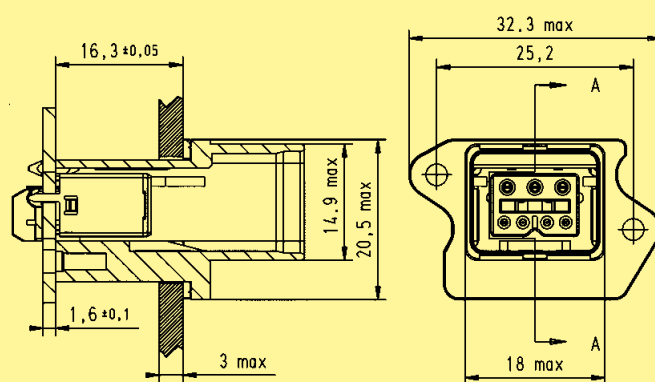



HARTING PushPull Hybrid, type acc. to IEC 61 076-3-106 variant 4
Hybrid connector

Advantages

- Combined data- and power-supply up to 5 A / 48 V included to one connector
- HARTING PushPull technology
- Compact design
- High packing density
- Sixfold condable
- Suitable for all Fast-Ethernet variants

Technical characteristics

Locking	PushPull Technology acc. to IEC 61 076-3-106 variant 4
Degree of protection	IP 65 / IP 67
Termination	Crimp
Cable diameter	AWG 26 for Ethernet AWG 20 for Power
Transmission performance	Category 5 / Class D up to 100 MHz acc. to ISO/IEC 11 801:2002, EN ISO 50 173-1
Number of contacts	Data: 4, shielded (Ethernet) Power: 3, (5 A / 48 V)
Housing material	Plastic, black
Flammability acc. to UL 94	V0

Identification	Part No.	Drawing	Dimensions in mm
----------------	----------	---------	------------------

Connector

HARTING PushPull Hybrid connector,
IP 65/ 67, black,
with cable gland and crimp contacts

straight

09 45 145 1300

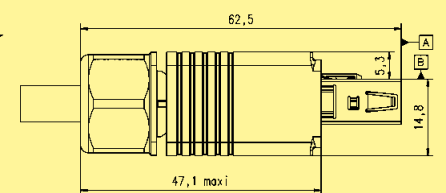
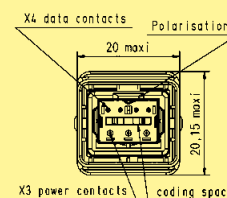

Accessories – Coding pin set

to avoid accidental incorrect mating
a coding system is required.
This coding pins are inserted without
loss of contact.

09 45 845 1300

Tools

Crimping tool for data contacts

09 99 000 0535

Crimping tool for power contacts

09 99 000 0175



Insertion and removal tool

for data contacts

09 99 000 0513

for power contacts

09 99 000 0171

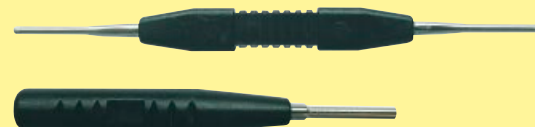



HARTING PushPull Hybrid, type acc. to IEC 61 076-3-106 variant 4 overmoulded Hybrid system cables

Advantages

- Combined data- and power-supply up to 5 A / 48 V included to one connector
- HARTING PushPull technology
- Robust design, suitable for industrial applications
- High packing density
- Sixfold codable
- Suitable for all Fast-Ethernet variants

Technical characteristics

Cable construction:	Twisted Pair shielded + 3 Power cables
Core structure	Data: 4x AWG 26/7 Power: 3x AWG 20/7
Transmission performance	Category 5 / Class D up to 100 MHz acc. to ISO/IEC 11801:2002, EN ISO 50173-1
Sheath material	FRNC
Cable-outer diameter	∅ (7.0 ±0.4) mm
Shielding	Shielding foil and shielding braid
Temperature range	-40 °C ... +80 °C
Colour	black

Identification	Part No.	Drawing	Dimensions in mm
----------------	----------	---------	------------------

System cables 2x HARTING PushPull Hybrid

Length	0.5 m	09 47 616 1005
	1 m	09 47 616 1010
	2 m	09 47 616 1020
	3 m	09 47 616 1030
	5 m	09 47 616 1050
	10 m	09 47 616 1100
	20 m	09 47 616 1200

System cables 1x HARTING PushPull Hybrid, second side open

Length	0.5 m	09 47 610 0005
	1 m	09 47 610 0010
	2 m	09 47 610 0020
	3 m	09 47 610 0030
	5 m	09 47 610 0050
	10 m	09 47 610 0100
	20 m	09 47 610 0200

Hybrid cable

ring	20 m	09 45 600 0331
ring	50 m	09 45 600 0341
ring	100 m	09 45 600 0301
reel	500 m	09 45 600 0321



Structure Hybrid cable

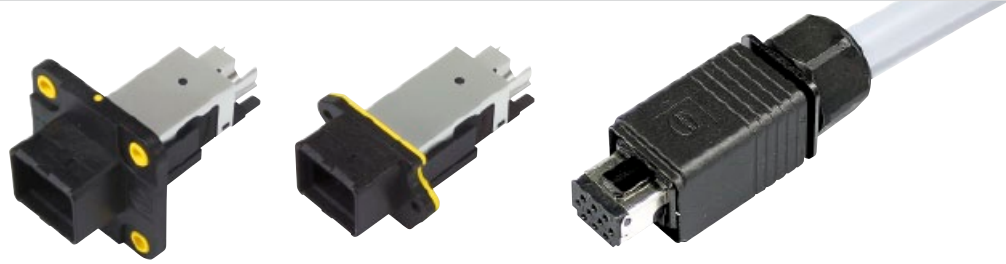

HARTING PushPull, type acc. to IEC 61 076-3-106 variant 4
10-poles 50 V / 5 A

Features

- HARTING PushPull technology
- For the transmission of analog, low voltage and bus signals
- Fully shielded
- 10 contacts
- Touch-proof
- Easy and fast cable installation

Technical characteristics

Locking	PushPull technology acc. to IEC 61 076-3-106 variant 4
Degree of protection	IP 65 / IP 67
Mating face	acc. to IEC/PAS 61 076-3-11x
Number of contacts	10
Electrical data acc. to DIN EN 61 984	5 A 50 V 1.5 kV 3
Contact resistance	10 mΩ
Termination	Crimp
Conductor cross section	0.75 mm ²
Conductor diameter	max. 2.1 mm
Outer cable diameter	4.9 ... 8.6 mm
Shielding	Fully shielded, 360° shielding contact
Mating cycles	min. 500
Temperature range	-40 °C ... +70 °C
Housing material	Plastic, black
Flammability acc. to UL 94	V0

Identification

Part No.

Drawing

Dimensions in mm

HARTING PushPull Signal

Connector set 10-poles
incl. plastic housing
and female insert

09 45 145 9010

Order D-Sub crimp female
contacts separately

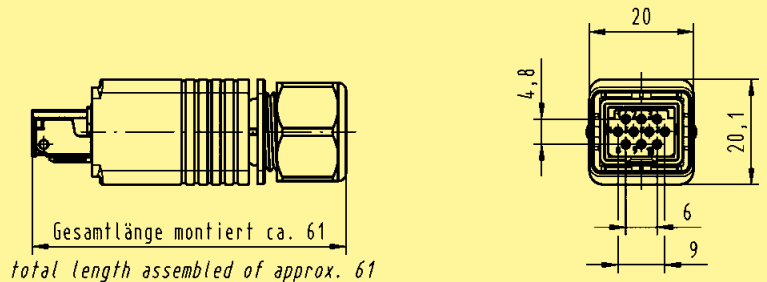

D-Sub crimp contacts for cable side

female, stamped
AWG 24-20; 0.25 - 0.56 mm²

09 67 000 8476¹⁾

female, turned
AWG 22-18; 0.33 - 0.82 mm²

09 67 000 3476¹⁾

¹⁾ To be used with crimp tool 09 99 000 0501. Suitable locator: 61 03 600 0531

Identification

Part No.

Drawing

Dimensions in mm

HARTING PushPull Signal

Insert for panel feed-through
HIFF, 10-poles
incl. male insert

Order D-Sub crimp male
contacts separately

09 45 545 9010

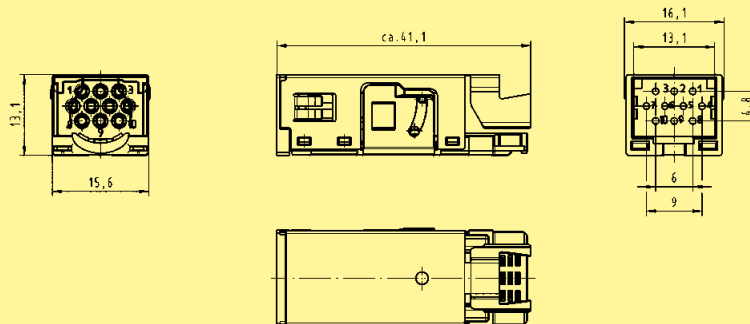

HARTING PushPull

housing bulkhead mounting,
plastic

EasyInstall

09 45 545 0032

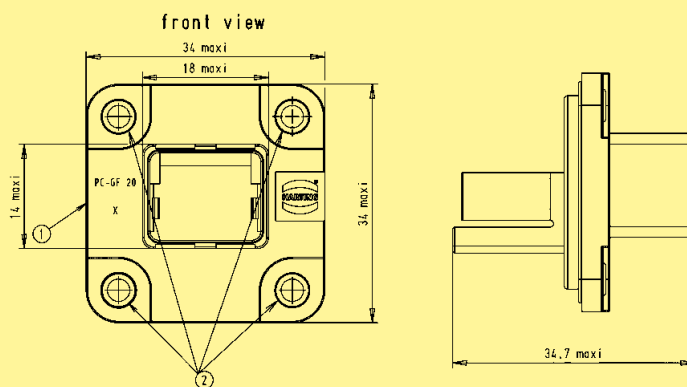

Compact

09 45 545 0028

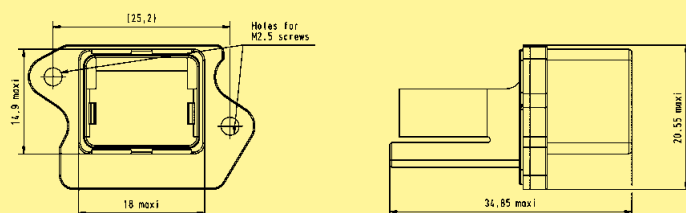

D-Sub crimp contacts for device side

male, stamped
AWG 24-20; 0.25-0.56 mm²

09 67 000 8576¹⁾

male, turned
AWG 22-18; 0.33-0.82 mm²

09 67 000 3576¹⁾

¹⁾ To be used with crimp tool 09 99 000 0501. Suitable locator: 61 03 600 0531

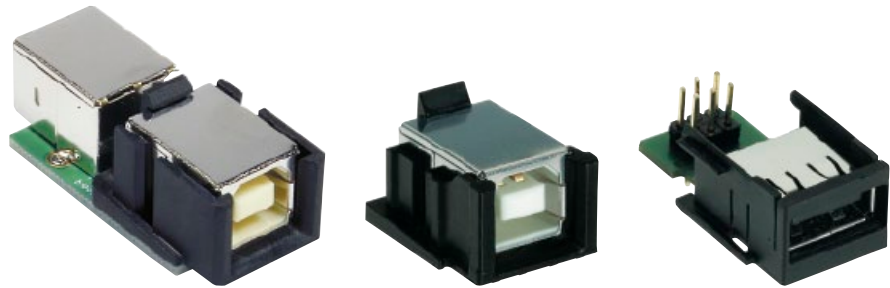

HARTING PushPull USB
Components device side and panel feed-throughs

Advantages

- HARTING PushPull technology
- Compact, space-saving design for the device integration of USB jacks
- USB 2.0 and 3.0 compatible

Technical characteristics

Mating face	USB 2.0 type B and USB 2.0 / 3.0 type A
Number of contacts	USB 2.0: 4 and USB 3.0: 9
Degree of protection	IP 65 / IP 67
Mating cycles	min. 750
Temperature range	-40 °C ... +70 °C

Identification

Part No.

Drawing

Dimensions in mm

Components device side

USB 2.0 type B

Solder jack, angled 90°, THT

09 45 541 1900

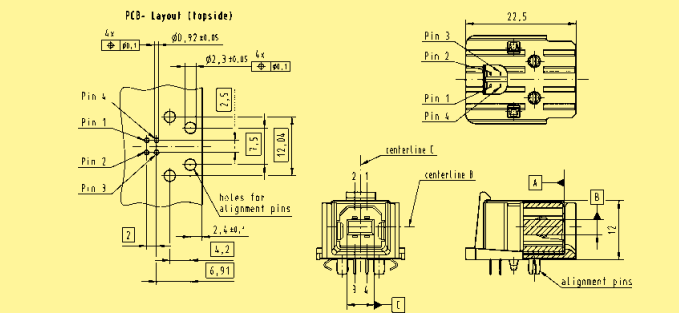

Adapter PCB USB 2.0 type A

Jack to pin header

Jack to solder points

09 45 541 1902

09 45 541 1903

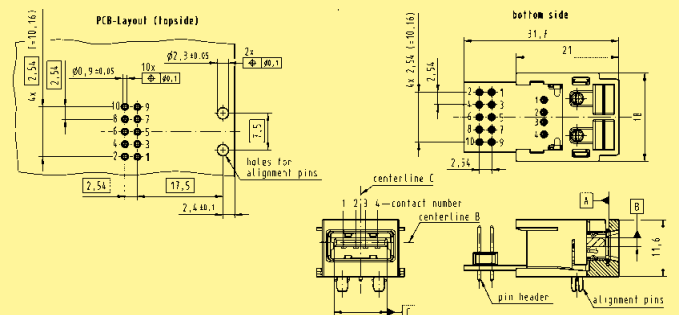

Adapter PCB USB 3.0 type A

Jack to pin header

09 45 541 1905

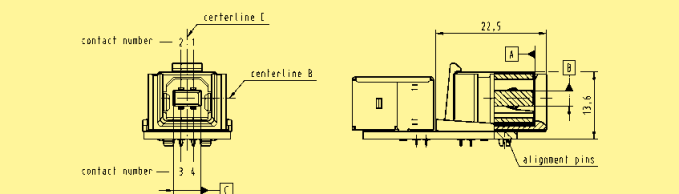

Adapter PCB USB 2.0 type B

Jack to jack

09 45 541 1906

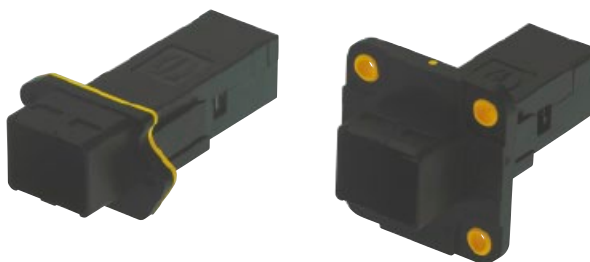

HARTING PushPull USB Panel feed-throughs

Advantages

- HARTING PushPull technology
- Compact, space-saving design for the device integration of USB jacks
- USB 2.0 and 3.0 compatible

Technical characteristics

Mating face	USB 2.0 / 3.0 type A
Number of contacts	USB 2.0: 4 and USB 3.0: 9
Degree of protection	IP 65 / IP 67
Mating cycles	min. 750
Temperature range	-40 °C ... +70 °C

Identification	Part No.	Drawing	Dimensions in mm
----------------	----------	---------	------------------

Panel feed-throughs

EasyInstall style

USB 2.0 type A
2 x jack

09 45 245 1903

USB 3.0 type A
2 x jack

09 45 245 1905

Compact style

USB 2.0 type A
2 x jack

09 45 245 1902

USB 3.0 type A
2 x jack

09 45 245 1904

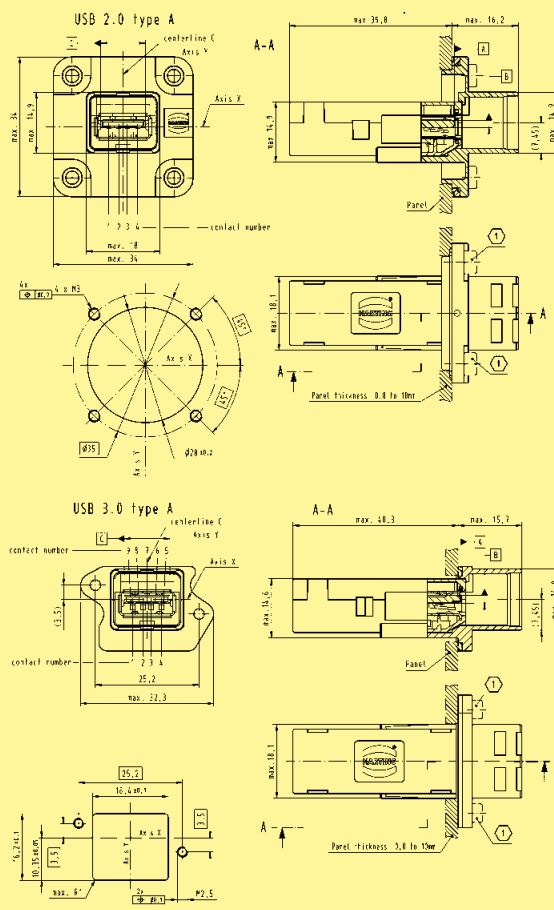



HARTING PushPull USB
System cables

PushPull

Advantages

- HARTING PushPull technology
- Compact, space-saving design for the device integration of USB jacks
- USB 2.0 and 3.0 compatible
- Fully shielded, 360° shielding contact
- Robust design, suitable for industrial applications

Technical characteristics

Mating face	USB 2.0 type B and USB 2.0 / 3.0 type A
Number of contacts	USB 2.0: 4 and USB 3.0: 9
Degree of protection	IP 65 / IP 67
Mating cycles	min. 750
Temperature range	-40 °C ... +70 °C

Identification	Part No.	Drawing	Dimensions in mm
System cables 2 x PushPull USB			
USB 2.0 type B	Length: 1.5 m 5.0 m	09 45 145 3902 09 45 145 3905	
USB 2.0 type B	Length: 1.5 m 5.0 m	09 45 145 1902 09 45 145 1905	
USB 2.0 type B	Length: 1.5 m 5.0 m	09 45 145 2902 09 45 145 2905	
System cables 1 x PushPull USB 1 x IP 20 USB			
USB 2.0 type B	Length: 1.5 m 5.0 m	09 45 145 3912 09 45 145 3915	
USB 2.0 type B	Length: 1.5 m 5.0 m	09 45 145 1912 09 45 145 1915	
USB 2.0 type B	Length: 1.5 m 5.0 m	09 45 145 2912 09 45 145 2915	
Other types and lengths on request			

HARTING offers with the HARTING PushPull Power connector an universal solution for the power supply in compact and robust applications. It is in this element wherever small dimensions are combined with a high protection class.

The connector is available in a 4-pole 48 V and a 2-pole 250 V version. The power contacts can carry up to 12 resp. 16 A each (see deratings). In spite of this high current carrying capacity the connector gets by with minimal dimensions and fulfils the industrial requirements for clearances and creepage distances at the same time (pollution degree 3 and overvoltage category III).

Additionally the HARTING PushPull Power connector offers the protection class of IP 67 and 65. Beside numerous industrial use cases it is thereby suited for diverse applications in the fields of transportation and telecommunication.

The cable side of the HARTING PushPull Power is terminated with crimping technology. For the receptacle several solutions with different termination technologies are offered.

- Regulations**
- VDE 0110
 - DIN EN 61984

Advantages

- Minimum space requirements in spite of high current carrying capacity
- Very compact housing in a high protection class
- Protection against contact on plug AND receptacle side enables an easy and safe installation
- For low voltage (48 V) and for power supply (250 V) available
- Codeable without losing contacts
- Different termination technologies for individual device integration

Typical application areas

- Factory and building automation
- Industrial electronics
- Telecommunication and wireless networks
- Transportation
- Industrial monitoring and camera systems
- Lighting and display technology
- Access control systems

Current carrying capacity

The current carrying capacity is determined in tests which are conducted on the basis of the DIN IEC 60512-5-2. The current carrying capacity is limited by the thermal properties of materials which are used for inserts as well as by the insulating materials. These components have a limiting temperature which should not be exceeded.

Example of a current capacity curve

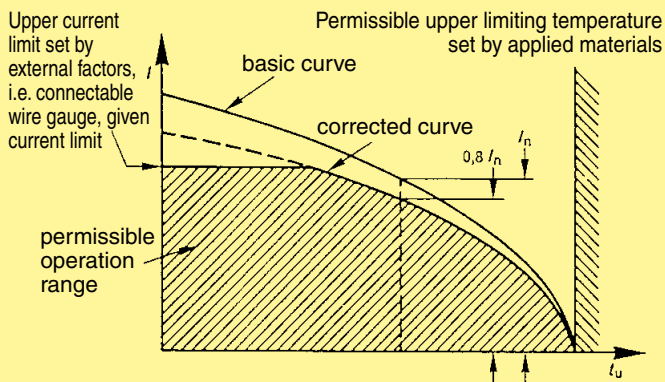

Derating-Diagramm for low voltage, 48 V; 4x 12 A

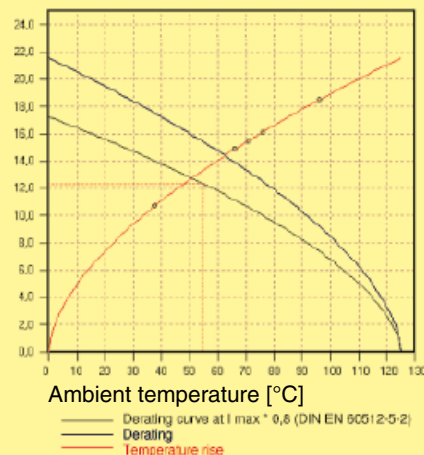

Derating-Diagramm for power supply, 250 V; 2x 16 A

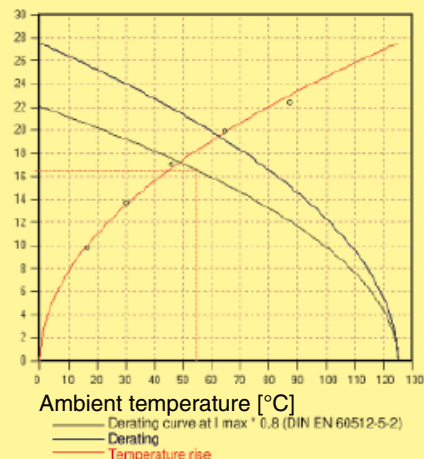



HARTING PushPull Power 4/0, type acc. to IEC 61076-3-106 variant 4
connector 4-poles 48 V / 12 A

Advantages

- Power connectors for devices
- EasyInstall panel feed-through for simple device integration
- Compact, space-saving design
- Touch-proof according to IEC DIN EN 60 529
- Polarisation with nose
- Cable side: Male with crimp termination
- 4 different coding variants without loss of contact

Technical characteristics

Locking	PushPull Technology acc. to IEC 61 076-3-106 variant 4
Degree of protection	IP 65 / IP 67
Number of contacts	4
Electrical data acc. to EN 61 984	12 A 48 V 1.5 kV 3
Cable diameter	4.9 ... 8.6 mm
Termination	Crimp
Termination cross section	0.75 - 2.5 mm ² (AWG 20 - 12) stranded
Mating cycles	min. 750
Temperature range	-40 °C ... +70 °C
Housing material	Plastic, black
Flammability acc. to UL 94	V0

Identification	Part No.	Drawing	Dimensions in mm
----------------	----------	---------	------------------

Connector set incl. 4 turned crimp contacts (male) for 1.5 mm ² , insulation body, housing, cable gland	09 46 145 4400 09 46 195 4400 ¹⁾		
Connector set without contacts	09 46 145 4401		
Accessories – crimp contacts male			
0.75 mm ² (AWG 20 - 18)	09 46 500 0403		
1.0 mm ² (AWG 18)	09 46 500 0407		
1.5 mm ² (AWG 16 - 14)	09 46 500 0401		
2.5 mm ² (AWG 12)	09 46 500 0405		
Accessories – crimp contacts female			
0.75 mm ² (AWG 20 - 18)	09 46 500 0404		
1.0 mm ² (AWG 18)	09 46 500 0408		
1.5 mm ² (AWG 16 - 14)	09 46 500 0402		
2.5 mm ² (AWG 12)	09 46 500 0406		
Accessories – Coding pin set to avoid accidental incorrect mating a coding system is required. This coding pins are inserted without loss of contact.	09 46 840 0000		

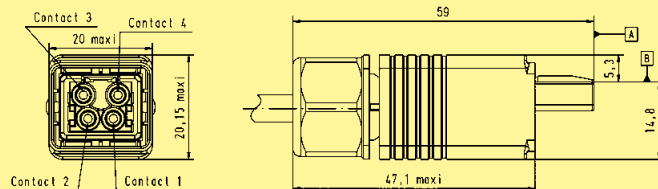

¹⁾ Metal version (without contacts)



HARTING PushPull Power 2/0, type acc. to IEC 61 076-3-106 variant 4 panel feed-through and connector, 3-poles, 250 V / 16 A

Advantages

- Power connectors for devices
- EasyInstall panel feed-through for simple device integration
- Compact, space-saving design
- Touch-proof according to IEC DIN EN 60 529
- Polarisation with nose
- Cable side: Male with crimp termination
- Device side: female with crimp termination
- 4 different coding variants without loss of contact

Technical characteristics

Locking	PushPull Technology acc. to IEC 61 076-3-106 variant 4
Degree of protection	IP 65 / IP 67
Number of contacts	2 + PE
Electrical data acc. to EN 61 984	16 A 250 V 4 kV 3
Cable diameter	4.9 ... 8.6 mm
Termination	Crimp
Termination cross section	0.75 - 2.5 mm ² (AWG 20 - 12) stranded
Mating cycles	min. 750
Temperature range	-40 °C ... +70 °C
Housing material	Plastic, black
Flammability acc. to UL 94	V0

Identification	Part No.	Drawing	Dimensions in mm
HARTING PushPull Power 2/0			
Panel feed-through set incl. 3 turned crimp contacts (female) for 1.5 mm ² , insulation body (black), housing bulkhead mounting EasyInstall	09 46 245 3430		
Panel feed-through set incl. 3 turned contacts (female) for 1.5 mm ² , insulation body (black), housing bulkhead mounting, with crimp termination	09 46 245 3410		
Power-female with solder termination angled	09 46 500 3400		
Power-female with crimp termination without contacts	09 46 500 3401		
Connector set incl. 3 turned crimp contacts (male) for 1.5 mm ² , insulation body (black), housing, cable gland	09 46 145 3410		
Connector set without contacts	09 46 145 3411		
Coding pin set to avoid accidental incorrect mating a coding system is required. This coding pins are inserted without loss of contact.	09 46 840 0000		

Identification
Part No.
**HARTING PushPull Power
8-indent crimping tool incl. positioner**

09 46 800 0000

**Locator HARTING PushPull Power
contacts for Buchanan crimping tool
(09 99 000 0001)**

09 46 800 0010

Insertion tool

09 46 800 0099

Extraction tool

09 46 800 0098

 For wire gauges
0.08 ... 4.0 mm²
(AWG 28 ... 12).

 For an easy insertion and
extraction of the male and
female crimp contacts into /
out of the insulator body.

Crimp connection

A perfect crimp connection is gastight, therefore corrosion free and amounts to a cold weld of the parts being connected. For this reason, major features in achieving high quality crimp connections are the design of the contact crimping parts and of course the crimping tool itself. Wires to be connected must be carefully matched with the correct size of crimp contacts. If these basic requirements are met, users will be assured of highly reliable connections with low contact resistance and high resistance to corrosive attack.

The economic and technical advantages are:

- Constant contact resistance as a result of precisely repeated crimp connection quality
- Corrosion free connections as a result of cold weld action
- Pre-preparation of cable forms with crimp contacts fitted
- Optimum cost cable connection

Requirements for crimp connectors are laid down in DIN IEC 60352-2, Amend. 2, as illustrated in the table.

Pull out force of stranded wire

The main criterion to judge the quality of a crimp connection is the retention force achieved by the wire conductor in the terminal section of the contact. DIN IEC 60352, part 2, defines the extraction force in relation to the cross-section of the conductor. When fitted using HARTING crimping tools and subject to their utilization in an approved manner, our crimp connectors comply with the required extraction forces.

Crimping tools

Crimping tools (hand operated or automatic) are carefully designed to produce with high pressure forming parts a symmetrical connection of the crimping part of the contact and the wire being connected with the minimum increase in size at the connection point. The positioner automatically locates the crimp and wire at the correct point in the tool.

A ratchet in the tool performs 2 functions:

- ① It prevents insertion of the crimp into the tool for crimping before the jaws are fully open
- ② It prevents the tool being opened before the crimping action is completed

Identical, perfectly formed, connections can be produced using this crimping system.

Tensile strength of crimped connections

Conductor cross-section		Tensile strength
mm ²	AWG	N
0.08	28	11
0.12	26	15
0.14		18
0.22	24	28
0.25		32
0.32	22	40
0.5	20	60
0.75		85
0.82	18	90
1.0		108
1.3	16	135
1.5		150
2.1	14	200
2.5		230
3.3	12	275
4.0		310

Extract from DIN IEC 60352-2, Amend. 2, Table IV

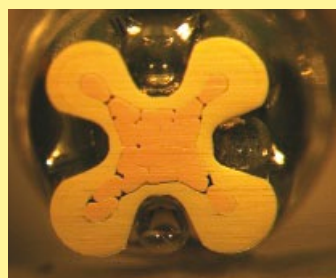

Crimp-cross section
HARTING crimp profile

Identification	Part No.	Drawing	Dimensions in mm
Transport protection for device side IP 40	09 45 845 0003		
Protection cover for device side IP 65 / IP 67 Version with passive locking without cord	09 45 845 0009 024		
Version with passive locking with plastic cord for fixing screw M3	09 45 845 0009		
Version with passive locking with nylon cord for fixing screw M2.5 / M3	09 45 845 0011 024		
Version with active locking without cord	09 45 845 0015		
Version with active locking with plastic cord for fixing screw M3	09 45 845 0014		
Version with active locking with nylon cord for fixing screw M2.5 / M3	09 45 845 0013		
Protection cover for connectors IP 65 / IP 67	09 45 845 0010		
Security clip for connectors can be sealed and protects against unauthorized unplugging	09 45 845 0020		



HARTING PushPull, type acc. to IEC 61 076-3-106 variant 4
cable to cable housing

Features

- HARTING PushPull technology
- Ideal for prototyping
- Can be combined with panel feed-throughs for power, data and signal

Technical characteristics

Locking	PushPull technology acc. to IEC 61 076-3-106 variant 4
Degree of protection	IP 65 / IP 67
Outer cable diameter	6.5 ... 9.5 mm
Mating cycles	min. 750
Temperature range	-40 °C ... +70 °C
Housing material	Plastic, black
Flammability acc. to UL 94	V0

Identification	Part No.	Drawing	Dimensions in mm
----------------	----------	---------	------------------

HARTING PushPull cable to cable housings, plastic
(Order housing bulkhead mounting and insert separately)

for outer cable diameter
6.5 ... 9.5 mm

09 45 345 0000

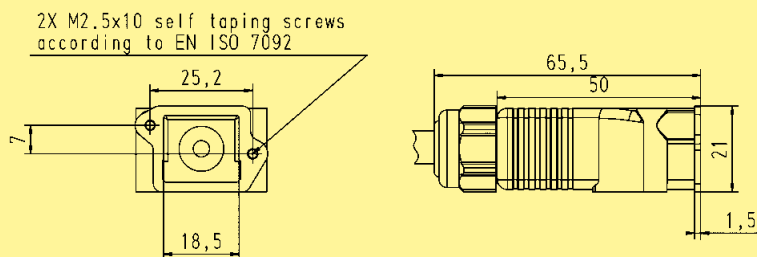

HARTING PushPull bulkhead housings, plastic
(Order housing bulkhead mounting and insert separately)

09 45 345 0001

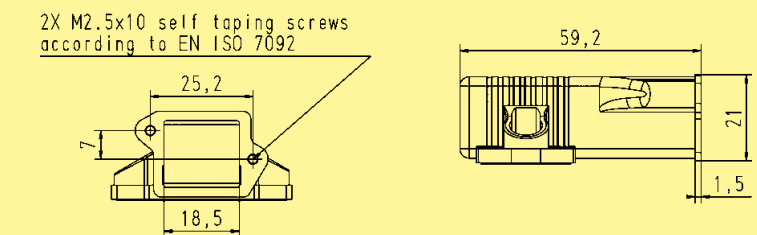

Suitable bulkhead housing, plastic

for RJ45 / Signal

09 45 545 0028

Inserts for RJ45 / Signal

RJ 45: 8-poles, Cat. 6 / class E_A
Ha-Vis preLink® set AWG 22/23
HARTING RJ Industrial® cable jack with IDC termination

20 82 001 0001

AWG 22-24, 8-poles 09 45 545 1562

AWG 24-28, 8-poles 09 45 545 1561

AWG 22-24, 4-poles, Cat. 5 09 45 545 1120

Signal: 10-poles, 50 V / 5 A*

09 45 545 9010

* Order D-Sub crimp male contacts separately (see pages 02.19 and 02.20)



Han® PushPull, type acc. to IEC 61 076-3-117 variant 14
Housing bulkhead mounting for device integration and RJ45 jacks

Features

- HARTING PushPull technology
- Compact design
- High packing density
- Device integration via RJ45 PCB connectors

Technical characteristics

Locking	PushPull technology acc. to IEC 61 076-3-117
Degree of protection	IP 65 / IP 67
Mating face	RJ45 acc. to IEC 60 603-7
Termination type	Jack with solder termination
Mating cycles	min. 750
Temperature range	-40 °C ... +70 °C
Housing material	Plastic, black
Flammability acc. to UL 94	V0

Identification

Part No.

Drawing

Dimensions in mm

Components device side

Housing bulkhead mounting plastic

09 35 002 0321

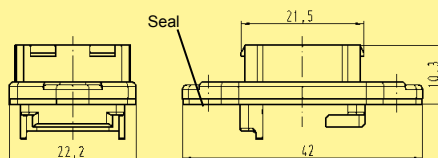

Panel cut out

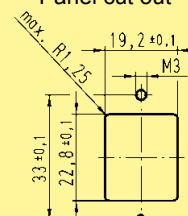

Dust protection cover IP 40 rubber (NBR)

09 35 002 5401

Protection cover IP 65 / IP 67

09 35 002 5402

RJ45 jack

Solder variant, 90° angled

09 35 002 2101

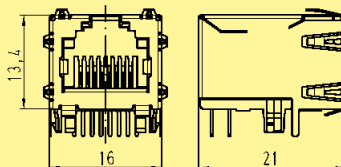

PCB layout

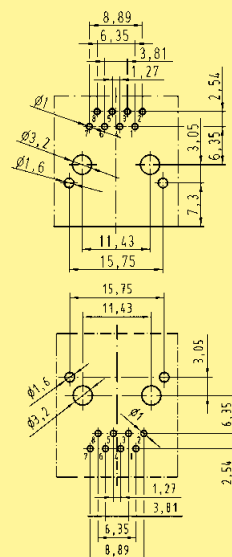

Solder variant, 180° straight

09 35 002 2102

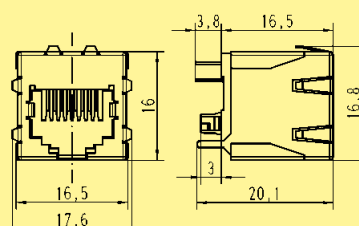



Han® PushPull, type acc. to IEC 61 076-3-117 variant 14
RJ45 panel feed through

Features

- HARTING PushPull technology
- Compact design
- High packing density
- Device integration via RJ45 PCB connectors

Technical characteristics

Locking	PushPull technology acc. to IEC 61 076-3-117
Degree of protection	IP 65 / IP 67
Mating face	RJ45 acc. to IEC 60 603-7
Transmission performance	acc. to ISO/IEC 11801:2002, EN 50 173-1, category 5 / class D up to 100 MHz resp. category 6 / class E _A up to 500 MHz
Transmission rate	10 / 100 Mbit/s and 1 / 10 Gbit/s
Number of contacts	8
Shielding	Fully shielded, 360° shielding contact (Cat. 6)
Mating cycles	min. 750
Temperature range	-40 °C ... +70 °C
Housing material	Plastic, black
Flammability acc. to UL 94	V0

Identification	Part No.	Drawing	Dimensions in mm
----------------	----------	---------	------------------

Han® PushPull RJ45
Panel feed through Cat. 6 including housing and HARTING RJ Industrial® 10G RJ45 bulkhead

09 35 225 0331

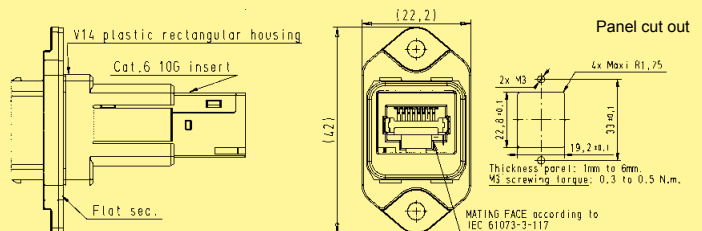

Panel feed through to mount HIFF inserts, e.g. Ha-VIS preLink® RJ45-module
Order inserts separately

09 35 012 0331

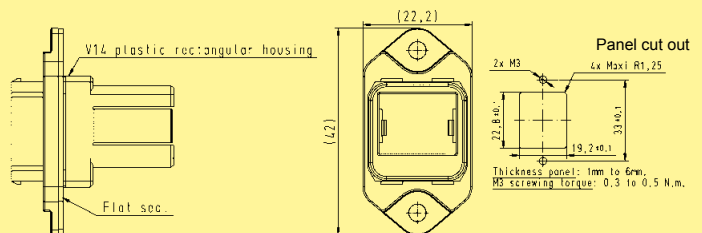

Ha-VIS preLink® set
RJ45 jack AWG 22/23

- consists of:
- 1x Ha-VIS preLink® module RJ45 jack
 - 1x Ha-VIS preLink® terminal module
 - 1x cable tie

20 82 001 0001

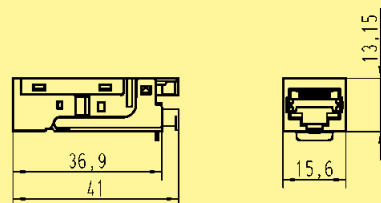

see page 01.10

HARTING RJ Industrial®
cable jack

AWG 22-24, 8-poles, Cat. 6	09 45 545 1562
AWG 24-28, 8-poles, Cat. 6	09 45 545 1561
AWG 22-24, 4-poles, Cat. 5	09 45 545 1120



Han® PushPull, type acc. to IEC 61 076-3-117 variant 14
RJ45 connector

Features

- HARTING PushPull technology
- Field-assembly connector with IDC contacts
- Fully shielded

Technical characteristics

Locking	PushPull technology acc. to IEC 61 076-3-117
Degree of protection	IP 65 / IP 67
Mating face	RJ45 acc. to IEC 60 603-7
Shielding	Fully shielded, 360° shielding contact
Number of contacts	4 respectively 8
Transmission performance	acc. to ISO/IEC 11 801:2002, EN 50 173-1, category 5 / class D up to 100 MHz, category 6 / class E _A up to 500 MHz
Transmission rate	10/100 Mbit/s and 1/10 Gbit/s
Termination for Cat. 5	with IDC contacts, no tools needed / field-assembly
	Conductor cross section AWG 24/7 - 22/7 (stranded) AWG 23/1 - 22/1 (solid)
	Cable diameter 1.6 mm
for Cat. 6	Conductor cross section AWG 22/7 - 27/7 (stranded) AWG 22/1 - 27/1 (solid)
	Cable diameter 1.6 mm
Mating cycles	min. 750
Temperature range	-40 °C ... +70 °C
Housing material	Plastic, black, UL 94 V0

Identification

Part No.

Drawing

Dimensions in mm

Connector set, plastic

incl. housing and male insert

Han® RJ Industrial
Category 5, 4-poles, IDC contacts

6.5 - 9.5 mm clamp range

5 - 8 mm clamp range

09 35 221 0421

09 35 222 0421

Han® RJ Industrial PN
Category 5, 4-poles, IDC contacts

6.5 - 9.5 mm clamp range

PROFINET-Identification:
PROFINET O-Plug RJ45

09 35 226 0421

Han® RJ Industrial 10G
Category 6, 8-poles, IDC contacts

6.5 - 9.5 mm clamp range

09 35 225 0421

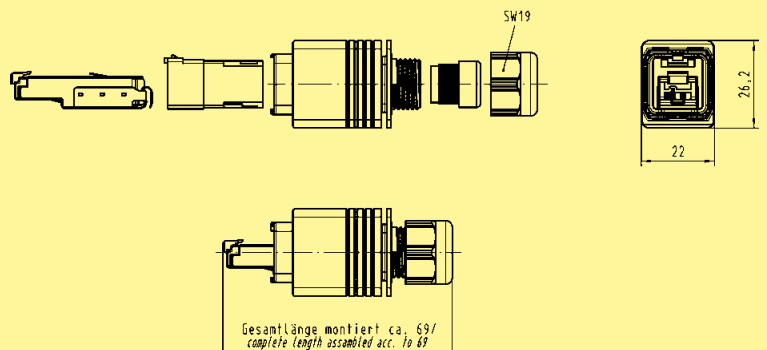



Han® PushPull, type acc. to IEC 61 076-3-117 variant 14 RJ45 connector

Features

- HARTING PushPull technology
- Field-assembly connector with piercing contacts
- Fully shielded

Technical characteristics

Locking	PushPull technology acc. to IEC 61 076-3-117
Degree of protection	IP 65 / IP 67
Mating face	RJ45 acc. to IEC 60 603-7
Shielding	Fully shielded, 360° shielding contact
Number of contacts	8
Transmission performance	acc. to ISO/IEC 11 801:2002, EN 50 173-1, category 6 _A / class E _A up to 500 MHz
Transmission rate	10/100 Mbit/s and 1/10 Gbit/s
Termination	with piercing contacts
Conductor cross section	AWG 24/7 - 27/7 (stranded)
Cable diameter	1.05 mm
Mating cycles	min. 750
Temperature range	-40 °C ... +70 °C
Housing material	Plastic, black, UL 94 V0

Identification

Part No.

Drawing

Dimensions in mm

Connector set, plastic

incl. housing and male insert
5 - 8 mm clamp range

Han® RJ Industrial
Category 6_A, 8-poles,
piercing contacts

09 35 227 0421

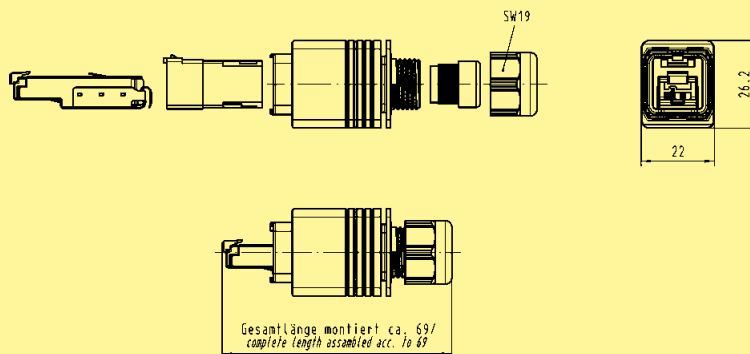

suitable assembly tool

09 45 800 0520



Han® PushPull, type acc. to IEC 61 076-3-117 variant 14
Housing bulkhead mounting for device integration and RJ45 jacks

Features

- HARTING PushPull technology
- Compact design
- High packing density
- Device integration via RJ45 PCB connectors

Technical characteristics

Locking	PushPull technology acc. to IEC 61 076-3-117
Degree of protection	IP 65 / IP 67
Mating face	RJ45 acc. to IEC 60 603-7
Termination type	Jack with solder termination
Mating cycles	min. 750
Temperature range	-40 °C ... +70 °C
Housing material	Zinc die-cast, nickel plated

Identification

Part No.

Drawing

Dimensions in mm

Components device side

Housing bulkhead mounting metal

09 35 002 0301

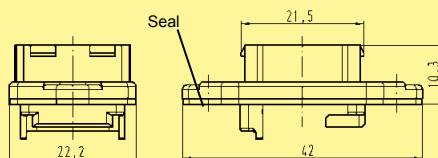

Panel cut out

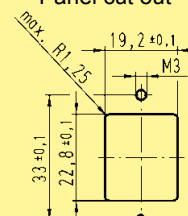

Dust protection cover IP 40 rubber (NBR)

09 35 002 5401

Protection cover IP 65 / IP 67

09 35 002 5402

RJ45 jack

Solder variant, 90° angled

09 35 002 2101

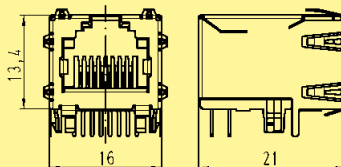

PCB layout

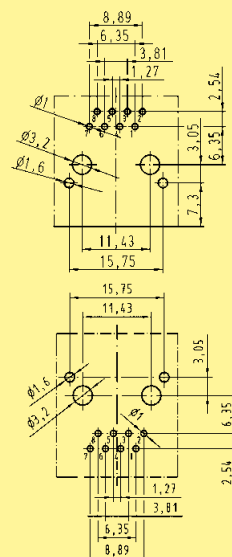

Solder variant, 180° straight

09 35 002 2102

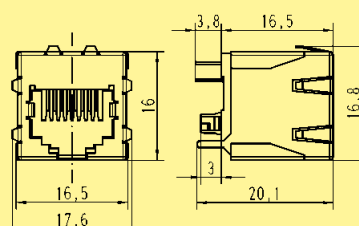



Han® PushPull, type acc. to IEC 61076-3-117 variant 14 RJ45 10G panel feed through



Features

- HARTING PushPull technology
- Compact and robust design
- 360° shielding
- RJ45 mating compatible
- Transmission category 6, performance class E_A, suitable for 1/10 Gigabit Ethernet
- PROFINET conform

Technical characteristics

Locking	PushPull technology acc. to IEC 61 076-3-117 variant 14 RJ45 acc. to IEC 60 603-7
Mating face	
Transmission performance	Category 6 / class E _A acc. to ISO/IEC 11 801:2002, EN 50 173-1
Transmission rate	10/100 Mbit/s and 1/10 Gbit/s
Shielding	Fully shielded, 360° shielding contact
Mounting	Screwable to cover plates
Degree of protection	IP 65 / IP 67
Mating cycles	min. 750
Temperature range	-40 °C ... +70 °C
Housing material	Zinc die-cast, nickel-plated

Identification

Part No.

Drawing

Dimensions in mm

Han® PushPull RJ45 10G

Panel feed through, Cat. 6 including bulkhead housing for rectangular panel cut out, flat seal and HARTING RJ Industrial® 10G RJ45 bulkhead, isolated bulkhead fixture

09 35 225 0311

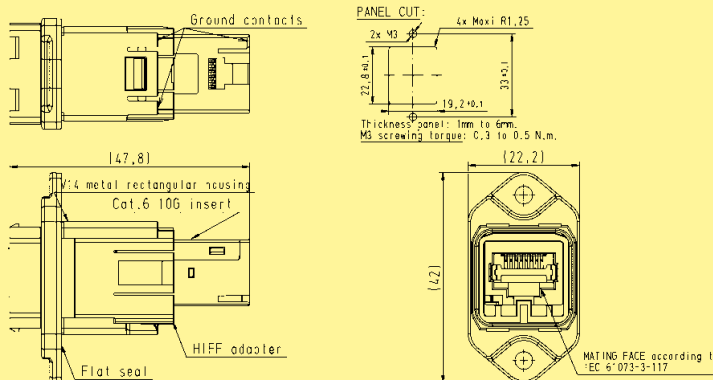

Panel feed through, Cat. 6 including bulkhead housing for circular panel cut out, flat seal and HARTING RJ Industrial® 10G RJ45 bulkhead, isolated bulkhead fixture

09 35 225 0312

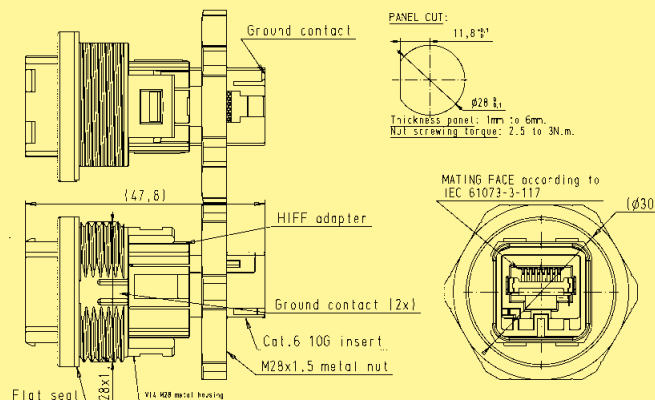

Identification

Part No.

Drawing

Dimensions in mm

Han® PushPull RJ45 10G

Panel feed-through to mount HIFF inserts, e.g. Ha-VIS preLink® RJ45-module, RJ Industrial cable jack
Order inserts separately

Bulkhead housing for rectangular panel cut out, incl. plastic adapter

09 35 012 0311

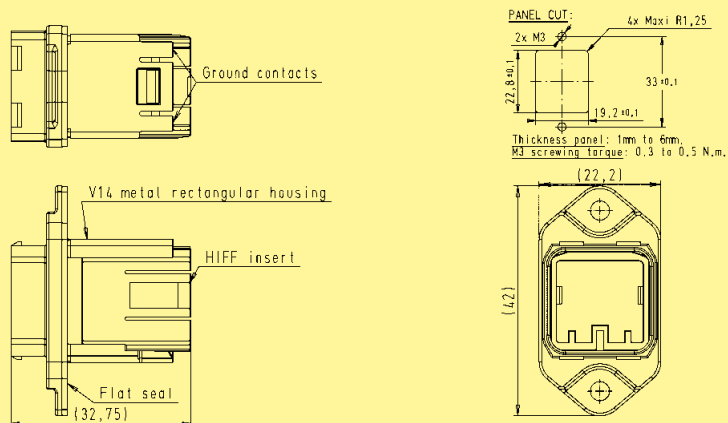

Bulkhead housing for circular panel cut out, incl. plastic adapter and fixing nut

09 35 012 0312

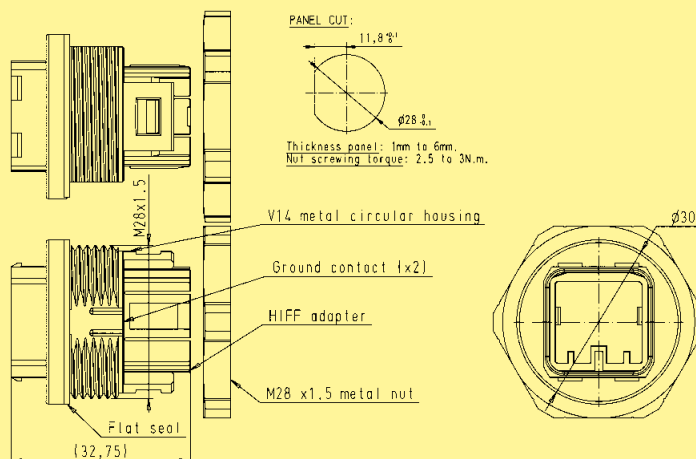

Ha-VIS preLink® set RJ45 jack AWG 22/23

consists of:

- 1x Ha-VIS preLink® module RJ45 jack
- 1x Ha-VIS preLink® terminal module
- 1x cable tie

20 82 001 0001

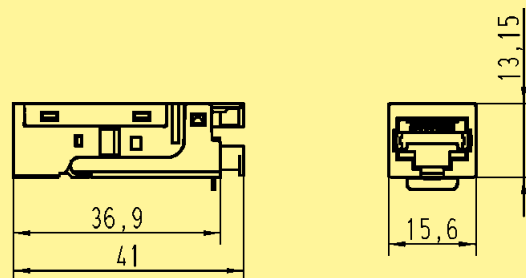

HARTING RJ Industrial® cable jack

AWG 22-24, 8-poles, Cat. 6

09 45 545 1562

AWG 24-28, 8-poles, Cat. 6

09 45 545 1561

AWG 22-24, 4-poles, Cat. 5

09 45 545 1120



Han® PushPull RJ45 Genderchanger Metal
Cat. 6 / Class E_A

Features

- High degree of protection IP 65 / IP 67
- Robust metal housing
- Standard PROFINET component of the German automotive production
- Allows usage of different cable types (Type B, C) e.g. in robots application
- Extension of cords according to PROFINET guideline
- Can be count as one connection acc. to IEC 11 801 Chapter 10.2.4

Technical characteristics

Transmission performance	Cat. 6 / Class E _A up to 500 MHz
Connector	Han® PushPull RJ45 (PROFINET conform)
Locking	PushPull technology acc. to IEC 61076-3-117 variant 14
Mating face	RJ45 acc. to IEC 60603-7
Mating cycles	min. 750
Housing material	Aluminium anodized
Dimensions	61.2 x 62 x 25.2 mm (unmated)
Degree of protection acc. to DIN 60529	IP 65 / IP 67 (mated)
Mounting	Wall mountable with 4 screws (type M5)
Temperature range	-20 °C ... +70 °C
Maximum permissible humidity	30 % ... 95 % (no condensation)

Identification

Part No.

Drawing

Dimensions in mm

Han® PushPull RJ45
Genderchanger metal

09 35 221 0501

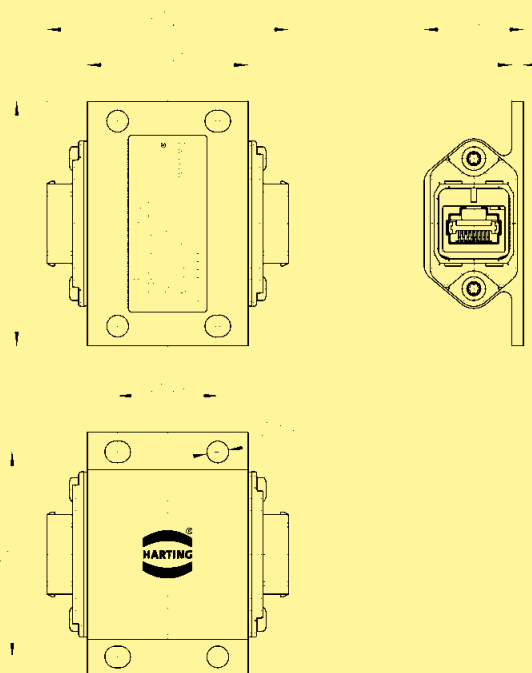



Han® PushPull RJ45 Coupling Metal Cat. 6 / Class E_A

Features

- High degree of protection IP 65 / IP 67
- Robust metal housing
- Standard PROFINET component of the German automotive production
- Extension of cords according to PROFINET guideline
- Can be count as one connection acc. to IEC 11801 Chapter 10.2.4
- For an easy robot termination and a fast exchange of tube packages

Technical characteristics

Transmission performance	Cat. 6 / Class E _A up to 500 MHz
Transmission rate	10/100 Mbit/s and 1/10 Gbit/s
Locking	PushPull technology acc. to IEC 61076-3-117 variant 14
Mating face	RJ45 acc. to IEC 60603-7
Number of contacts	8
Usable cables	
Termination cross section	AWG 22-24 stranded/solid
Cable diameter	5 ... 9 mm
Conductor diameter	1.3 ... 1.6 mm
Mating cycles	min. 750
Housing material	Aluminium die-cast
Degree of protection acc. to DIN 60529	IP 65 / IP 67
Temperature range	-40 °C ... +70 °C

Identification

Part No.

Drawing

Dimensions in mm

Han® PushPull RJ45 Coupling metal

including housing,
Ha-VIS preLink® RJ45 jack,
bulkhead housing and cable gland

61 04 201 1084

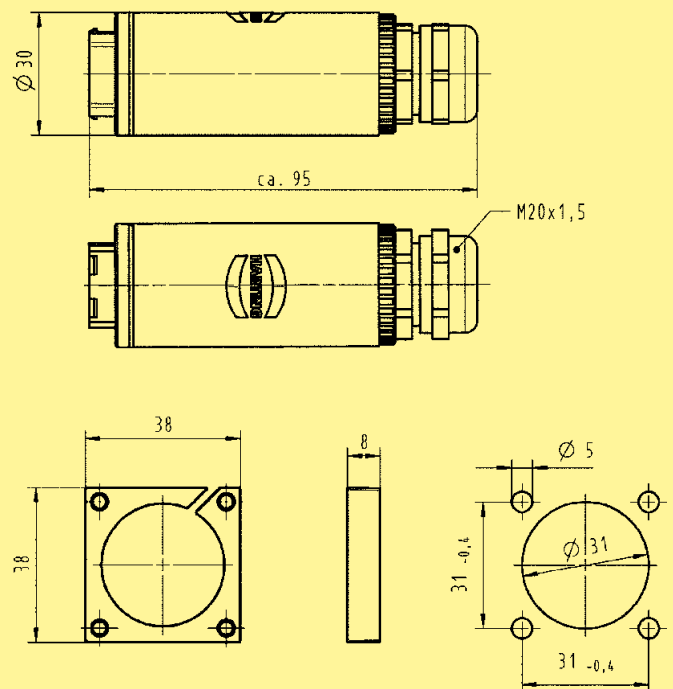

Fixing flange

61 04 600 0182



Han® PushPull, type acc. to IEC 61 076-3-117 variant 14 RJ45 connector

Features

- HARTING PushPull technology
- Field-assembly connector with IDC contacts
- Fully shielded

Technical characteristics

Locking	PushPull technology acc. to IEC 61 076-3-117
Degree of protection	IP 65 / IP 67
Mating face	RJ45 acc. to IEC 60 603-7
Shielding	Fully shielded, 360° shielding contact
Number of contacts	4 respectively 8
Transmission performance	acc. to ISO/IEC 11 801:2002, EN 50 173-1, category 5 / class D up to 100 MHz category 6 / class E _A up to 500 MHz
Transmission rate	10/100 Mbit/s and 1/10 Gbit/s
Termination	with IDC contacts, no tools needed / field-assembly
for Cat. 5	
Conductor cross section	AWG 24/7 - 22/7 (stranded) AWG 23/1 - 22/1 (solid)
Cable diameter	1.6 mm
for Cat. 6	
Conductor cross section	AWG 22/7 - 27/7 (stranded) AWG 22/1 - 27/1 (solid)
Cable diameter	1.6 mm
Mating cycles	min. 750
Temperature range	-40 °C ... +70 °C
Housing material	Zinc die-cast, nickel-plated

Identification	Part No.	Drawing	Dimensions in mm
----------------	----------	---------	------------------

Connector set, metal
incl. housing and male insert
4 - 11 mm clamp range

Han® RJ Industrial
Category 5, 4-poles, IDC contacts

09 35 221 0401

Han® RJ Industrial PN
Category 5, 4-poles, IDC contacts
PROFINET-Identification:
PROFINET O-Plug RJ45

09 35 226 0401

Han® RJ Industrial 10G
Category 6, 8-poles, IDC contacts

09 35 225 0401

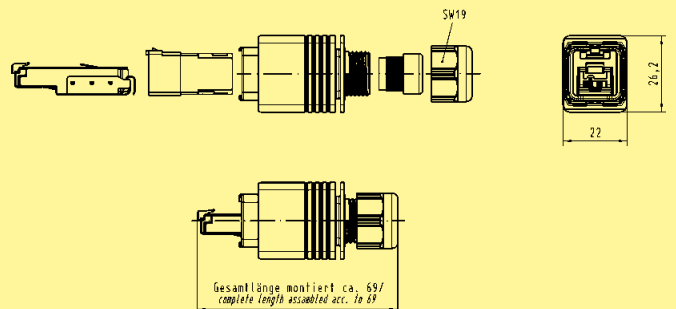

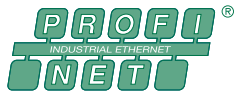

Han® PushPull, type acc. to IEC 61 076-3-117 variant 14
RJ45 connector angled

Features

- HARTING PushPull technology
- Angled cable exit 45° to the top / bottom for a space saving cabling
- Field-assembly connector with IDC contacts
- Fully shielded

Technical characteristics

Locking	PushPull technology acc. to IEC 61 076-3-117
Degree of protection	IP 65 / IP 67
Mating face	RJ45 acc. to IEC 60 603-7
Shielding	Fully shielded, 360° shielding contact
Number of contacts	4 respectively 8
Transmission performance	acc. to ISO/IEC 11 801:2002, EN 50 173-1, category 5 / class D up to 100 MHz category 6 / class E _A up to 500 MHz
Transmission rate	10/100 Mbit/s and 1/10 Gbit/s
Termination	with IDC contacts, no tools needed / field-assembly
for Cat. 5	
Conductor cross section	AWG 24/7 - 22/7 (stranded) AWG 23/1 - 22/1 (solid)
Cable diameter	1.6 mm
for Cat. 6	
Conductor cross section	AWG 22/7 - 27/7 (stranded) AWG 22/1 - 27/1 (solid)
Cable diameter	1.6 mm
Mating cycles	min. 750
Temperature range	-40 °C ... +70 °C
Housing material	Zinc die-cast, nickel-plated

Identification

Part No.

Drawing

Dimensions in mm

Connector set, metal

incl. housing
and male insert

Han® RJ Industrial PN
Category 5, 4-poles, IDC contacts,
6.5 - 9.5 mm clamp range

Cable exit bottom side

09 35 226 0402

Cable exit top side

09 35 226 0403

Han® RJ Industrial 10G
Category 6, 8-poles, IDC contacts,
6.5 - 9.5 mm clamp range

Cable exit bottom side

09 35 225 0402

Cable exit top side

09 35 225 0403

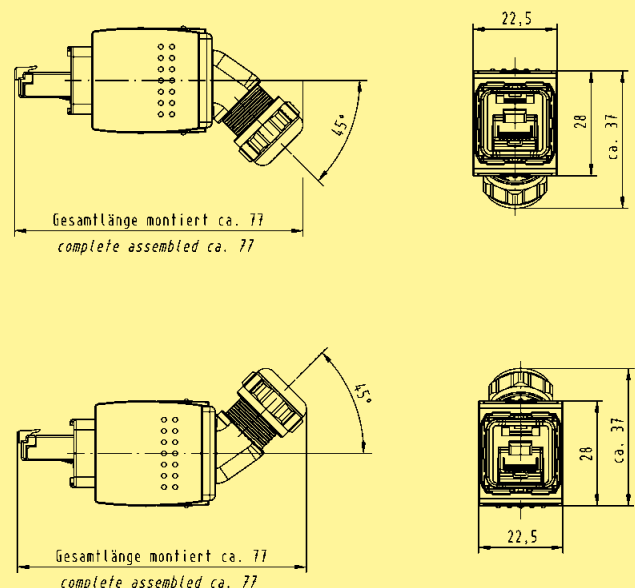



Han® PushPull, type acc. to IEC 61 076-3-117 variant 14
RJ45 connector

Features

- HARTING PushPull technology
- Compact design
- For space saving fitting conditions
- Connector with piercing contacts
- 360° shielding

Technical characteristics

Locking	PushPull technology acc. to IEC 61 076-3-117
Degree of protection	IP 65 / IP 67
Mating face	RJ45 acc. to IEC 60 603-7
Shielding	Fully shielded, 360° shielding contact
Number of contacts	8
Transmission performance	acc. to ISO/IEC 11 801:2002, EN 50 173-1, category 6 _A / class E _A up to 500 MHz
Transmission rate	10/100 Mbit/s and 1/10 Gbit/s
Termination	with piercing contacts
Conductor cross section	AWG 24/7 - 27/7 (stranded)
Cable diameter	1.05 mm
Mating cycles	min. 750
Temperature range	-40 °C ... +70 °C
Housing material	Zinc die-cast, nickel-plated

Identification

Part No.

Drawing

Dimensions in mm

Connector set, metal

incl. housing and male insert
4 - 11 mm clamp range

Han® RJ Industrial
Category 6, 8-poles,
piercing contacts



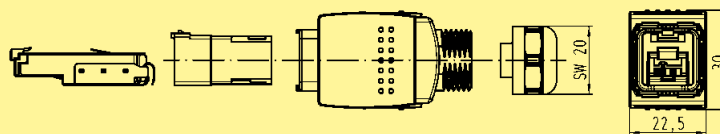

09 35 227 0401



suitable assembly tool

09 45 800 0520

Han® PushPull, type acc. to IEC 61 076-3-117 variant 14 Accessories

Identification	Part No.	Drawing	Dimensions in mm
<p>Han® PushPull dust protection cover IP 40 rubber (NBR) for device side</p>	09 35 002 5401		
<p>Han® PushPull protection cover IP 65 / IP 67 for device side</p> <p>without fixing cord</p>	09 35 002 5403 XL ¹⁾		
with fixing cord	09 35 002 5402 09 35 002 5402 XL ¹⁾		
with nylon fixing cord	09 35 002 5404 09 35 002 5404 XL ²⁾		
<p>Han® PushPull dust protection cover IP 40 for cable side</p>	09 35 002 5412		
<p>Han® PushPull protection cover IP 65 / IP 67 for cable side</p> <p>without fixing cord</p>	09 35 002 5411		
with nylon fixing cord	09 35 002 5413		

¹⁾ Packaging with 100 pieces
²⁾ Packaging with 250 pieces

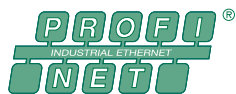

Han® PushPull, type acc. to IEC 61 076-3-117 variant 14
 Housing bulkhead mounting for device integration
 Optical connector based on SCRJ

PushPull

Features

- HARTING PushPull technology
- Compact design
- High packing density
- Device integration via transceiver
- Han® PushPull SCRJ for POF is according the requirements of AIDA (German Domestic Automobile Manufacturers)

Technical characteristics

Locking	PushPull technology
Degree of protection	IP 65 / IP 67
Mating face	SCRJ acc. to IEC 61 754-24
Fiber Typen	POF ¹⁾ 1 mm HCS ²⁾ 200 µm / 230 µm MM 62.5 µm / 125 µm MM 50 µm / 125 µm SM 10 µm / 125 µm
Mating cycles	min. 750
Temperature range	-40 °C ... +70 °C
Housing material	Plastic, black
Flammability acc. to UL 94	V0

Identification

Part No.

Drawing

Dimensions in mm

Components device side

Housing bulkhead mounting
 Optical transceiver
 not included

plastic

09 35 002 0323

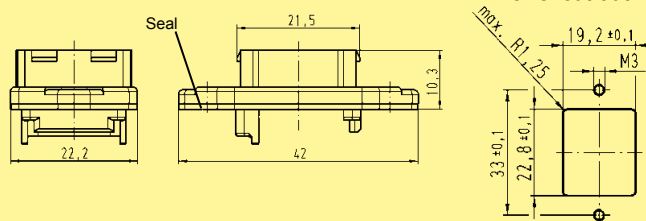

Dust protection cover IP 40
 rubber (NBR)

09 35 002 5401

Protection cover IP 65 / IP 67

09 35 002 5402

Reference for transceiver
 as well as mounting instruction
 on request

¹⁾ POF = Polymer-Optical Fibre

²⁾ HCS® = Hard Clad Silica (registered trademark of SpecTran Corporation)



Han® PushPull, type acc. to IEC 61 076-3-117 variant 14
 RJ45 panel feed through
 for optical connector based on SCRJ

Features

- HARTING PushPull technology
- Compact design
- High packing density
- Han® PushPull SCRJ for POF is according the requirements of AIDA (German Domestic Automobile Manufacturers)

Technical characteristics

Locking	PushPull technology
Degree of protection	IP 65 / IP 67
Mating face	SCRJ acc. to IEC 61 754-24
Fiber Typen	POF ¹⁾ 1 mm HCS ²⁾ 200 µm / 230 µm MM 62.5 µm / 125 µm MM 50 µm / 125 µm SM 10 µm / 125 µm
Mating cycles	min. 750
Temperature range	-40 °C ... +70 °C
Housing material	Plastic, black
Flammability acc. to UL 94	V0

Identification

Part No.

Drawing

Dimensions in mm

Han® PushPull SCRJ

Panel feed through

SC contacts order separately

09 35 242 0333

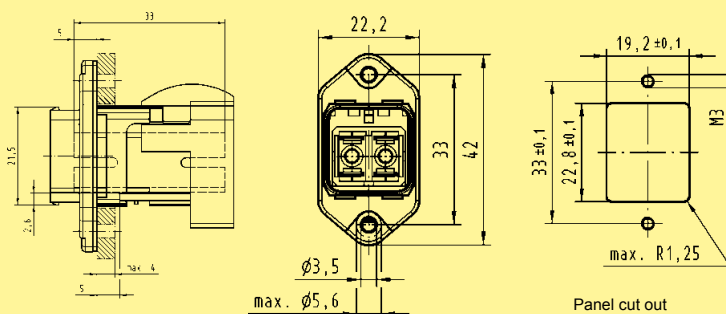

SCRJ IP 20 POF connector

09 35 002 4002

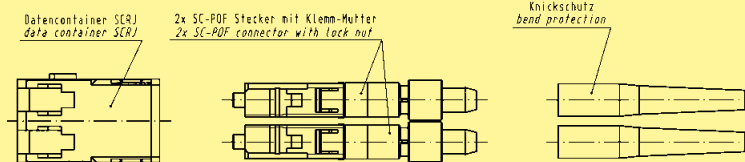

Contacts

SC POF contact, 1 mm	20 10 001 5217
SC 125 GI contact	20 10 125 5211
SC 230 HCS contact	20 10 230 5211

1) POF = Polymer-Optical Fibre
 2) HCS® = Hard Clad Silica (registered trademark of SpecTran Corporation)

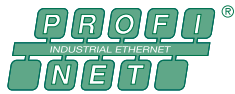

Han® PushPull, type acc. to IEC 61 076-3-117 variant 14
SCRJ connector



PushPull

Features

- HARTING PushPull technology
- Compact design
- High packing density
- Han® PushPull SCRJ for POF is according the requirements of AIDA (German Domestic Automobile Manufacturers)
- Field installable

Technical characteristics

Locking	PushPull technology
Degree of protection	IP 65 / IP 67
Mating face	SCRJ acc. to IEC 61 754-24
Fiber Typen	POF ¹⁾ 1 mm HCS ²⁾ 200 µm / 230 µm MM 62.5 µm / 125 µm MM 50 µm / 125 µm SM 10 µm / 125 µm
Mating cycles	min. 750
Temperature range	-40 °C ... +70 °C
Housing material	Plastic, black
Flammability acc. to UL 94	V0
Cable diameter	6.5 - 9.5 mm

Identification

Part No.

Drawing

Dimensions in mm

Connector set, plastic

incl. housing and SCRJ insert,
POF contacts

09 35 241 0421

PROFINET-Identification:
PROFINET O-Plug SCRJ

incl. housing and SCRJ insert
SC contacts order separately

09 35 241 0422

SCRJ IP 20 POF connector

09 35 002 4002

Dust protection cover IP 40

09 35 002 5412

Protection cover IP 65 / IP 67

09 35 002 5411

Contacts

SC POF contact, 1 mm
SC 125 GI contact
SC 230 HCS contact

20 10 001 5217
20 10 125 5211
20 10 230 5211

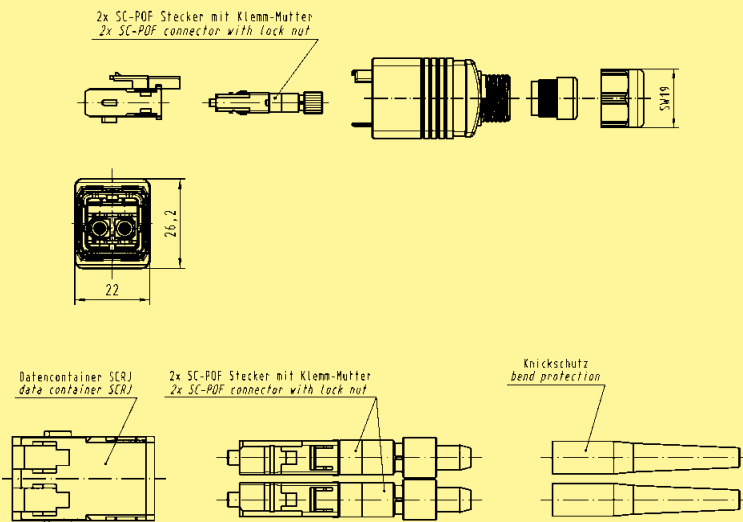

Tooling see page 02.51

¹⁾ POF = Polymer-Optical Fibre

²⁾ HCS® = Hard Clad Silica (registered trademark of SpecTran Corporation)



Han® PushPull, type acc. to IEC 61 076-3-117 variant 14
 Housing bulkhead mounting for device integration
 Optical connector based on SCRJ

Features

- HARTING PushPull technology
- Compact design
- High packing density
- Device integration via transceiver
- Han® PushPull SCRJ for POF is according the requirements of AIDA (German Domestic Automobile Manufacturers)

Technical characteristics

Locking	PushPull technology
Degree of protection	IP 65 / IP 67
Mating face	SCRJ acc. to IEC 61 754-24
Fiber Typen	POF ¹⁾ 1 mm HCS ²⁾ 200 µm / 230 µm MM 62.5 µm / 125 µm MM 50 µm / 125 µm SM 10 µm / 125 µm
Mating cycles	min. 750
Temperature range	-40 °C ... +70 °C
Housing material	Zinc die-cast, nickel plated

Identification	Part No.	Drawing	Dimensions in mm
----------------	----------	---------	------------------

Components device side

Housing bulkhead mounting
 Optical transceiver
 not included

metal

09 35 002 0303

Dust protection cover IP 40
 rubber (NBR)

09 35 002 5401

Protection cover IP 65 / IP 67

09 35 002 5402

Reference for transceiver
 as well as mounting instruction
 on request

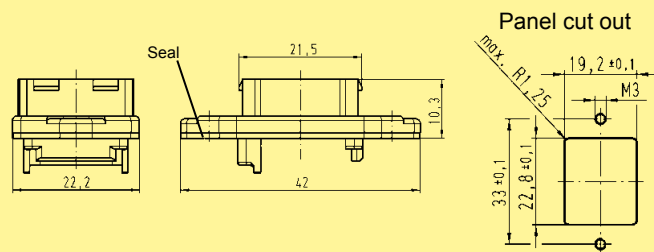

1) POF = Polymer-Optical Fibre
 2) HCS® = Hard Clad Silica (registered trademark of SpecTran Corporation)



Han® PushPull, type acc. to IEC 61 076-3-117 variant 14
 RJ45 panel feed through
 for optical connector based on SCRJ

Features

- HARTING PushPull technology
- Compact design
- High packing density
- Han® PushPull SCRJ for POF is according the requirements of AIDA (German Domestic Automobile Manufacturers)

Technical characteristics

Locking	PushPull technology
Degree of protection	IP 65 / IP 67
Mating face	SCRJ acc. to IEC 61 754-24
Fiber Typen	POF ¹⁾ 1 mm HCS ²⁾ 200 µm / 230 µm MM 62.5 µm / 125 µm SM 10 µm / 125 µm
Mating cycles	min. 750
Temperature range	-40 °C ... +70 °C
Housing material	Zinc die-cast, nickel plated

Identification

Part No.

Drawing

Dimensions in mm

Han® PushPull SCRJ

Panel feed through

09 35 242 0313

SC contacts order separately

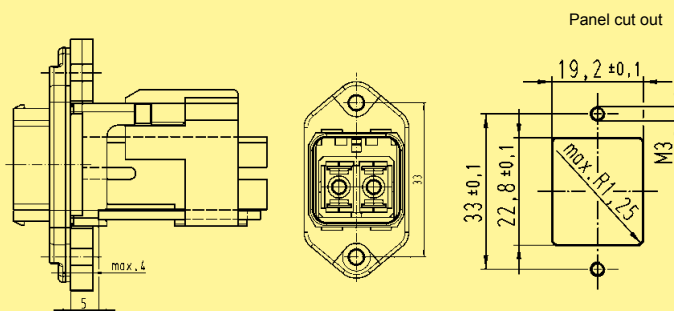

SCRJ IP 20 POF connector

09 35 002 4002

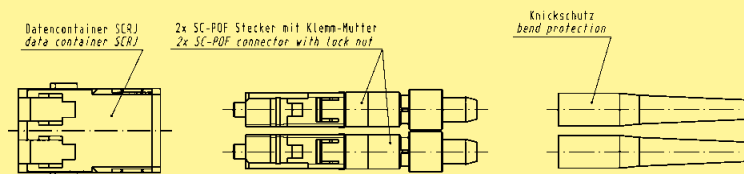

Contacts

- SC POF contact, 1 mm
- SC 125 GI contact
- SC 230 HCS contact

20 10 001 5217
 20 10 125 5211
 20 10 230 5211

¹⁾ POF = Polymer-Optical Fibre
²⁾ HCS® = Hard Clad Silica (registered trademark of SpecTran Corporation)



Han® PushPull, type acc. to IEC 61 076-3-117 variant 14
SCRJ connector

Features

- HARTING PushPull technology
- Compact design
- High packing density
- Han® PushPull SCRJ for POF is according the requirements of AIDA (German Domestic Automobile Manufacturers)
- Field installable

Technical characteristics

Locking	PushPull technology
Degree of protection	IP 65 / IP 67
Mating face	SCRJ acc. to IEC 61 754-24
Fiber Typen	POF ¹⁾ 1 mm HCS ²⁾ 200 µm / 230 µm MM 62.5 µm / 125 µm MM 50 µm / 125 µm SM 10 µm / 125 µm
Mating cycles	min. 750
Temperature range	-40 °C ... +70 °C
Housing material	Zinc die-cast, nickel plated
Flammability acc. to UL 94	V0
Cable diameter	6.5 - 9.5 mm

Identification	Part No.	Drawing	Dimensions in mm
----------------	----------	---------	------------------

Connector set, metal
incl. housing and SCRJ insert,
POF contacts

09 35 241 0401

PROFINET-Identification:
PROFINET O-Plug SCRJ

incl. housing and SCRJ insert
SC contacts order separately

09 35 241 0402

SCRJ IP 20
POF connector

09 35 002 4002

Dust protection cover IP 40

09 35 002 5412

Protection cover IP 65 / IP 67

09 35 002 5411

Contacts

- SC POF contact, 1 mm
- SC 125 GI contact
- SC 230 HCS contact

20 10 001 5217
20 10 125 5211
20 10 230 5211

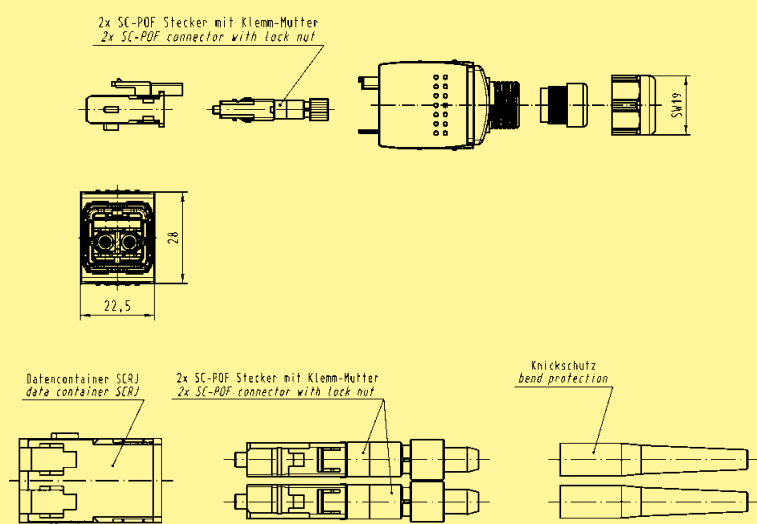



Han® PushPull SCRJ POF
Assembly tools for polymer-optical fibres

Features

- Cable insulation (PUR / PVC) is stripped without damage
- The 'stripping' and 'precision cutting' operations are completed within the one tool
- Specialized cutting method with an automatically advancing round blade for an accurate cutting result requiring no final polishing
- Optical display indicating remaining operations
- Simultaneous handling of twin fibers (duplex mode)

Technical characteristics

Connector type	SCRJ connector acc. to IEC 61 754-24
Locking	PushPull technology acc. to IEC 61 076-3-117 variant 14 (AIDA compliant)
Insertion loss	typically 1.5 to 2.0 dB
Termination SC contacts	Fast termination technique, reusable
Fibre dimensions	POF 980 / 1000 µm
Fibre outer diameter	2.2 mm
Cable outer diameter	7 to 8.5 mm
No. of cutting operations	Maximum 1260

Identification

Part No.

Drawing

Dimensions in mm

Assembly tool set for POF cutting, without final polishing

The set contains
 - one stripping and cutting tool for 1260 operations
 - one sheath stripping tool
 - one Kevlar shear
 - one positioner for SCRJ contacts
 Supplied in a robust plastic case

09 35 000 9913

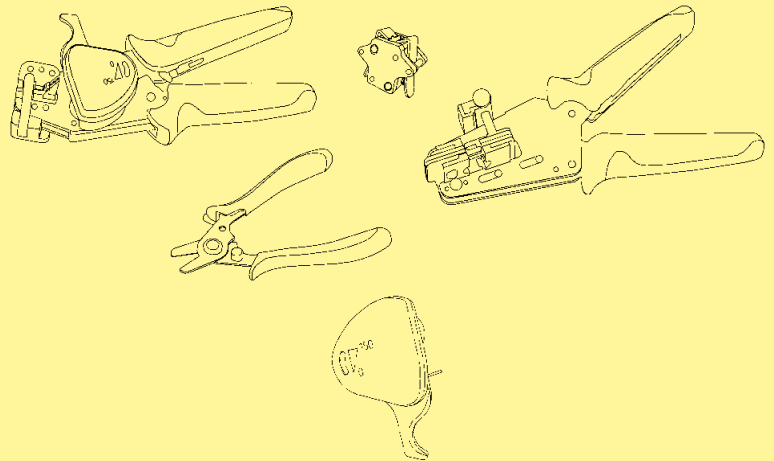

Replacement cutting tool for 1260 operations

09 35 000 9914

Assembly tool set for POF cutting, with final polishing

Without an optical meter
 With an optical meter

20 99 000 3016
 20 99 000 3013

Polishing wheel (grinding wheel) for POF cables 2.2

20 99 000 1099

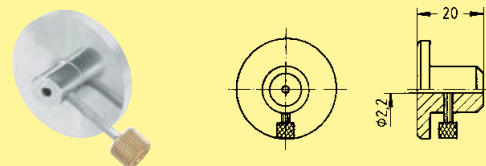

Sand paper for POF, grain size 1000

20 80 001 9911



Han® PushPull, type acc. to IEC 61 076-3-117 variant 14
10-poles 50 V / 5 A

Features

- HARTING PushPull technology
- For the transmission of analog, low voltage and bus signals
- Fully shielded
- 10 contacts
- Touch-proof
- Easy and fast cable installation

Technical characteristics

Locking	PushPull technology acc. to IEC 61 076-3-117 variant 14
Degree of protection	IP 65 / IP 67
Mating face	acc. to IEC/PAS 61076-3-11x
Number of contacts	10
Electrical data acc. to DIN EN 61984	5 A 50 V 1.5 kV 3
Contact resistance	10 mΩ
Termination	Crimp
Conductor cross section	AWG 24 ... 18; 0.25 ... 0.82 mm ²
Conductor diameter	max. 2.1 mm
Outer cable diameter	6.5 ... 9.5 mm / 4 ... 11 mm
Shielding	Fully shielded, 360° shielding contact
Mating cycles	min. 500
Temperature range	-40 °C ... +70 °C
Housing material	Plastic, black Zinc die-cast, nickel-plated
Flammability acc. to UL 94	V0

Identification	Part No.	Drawing	Dimensions in mm
----------------	----------	---------	------------------

Han® PushPull Signal Insert

for panel feed-through HIFF,
10-poles
incl. male insert

Order D-Sub crimp male
contacts separately

09 45 545 9010

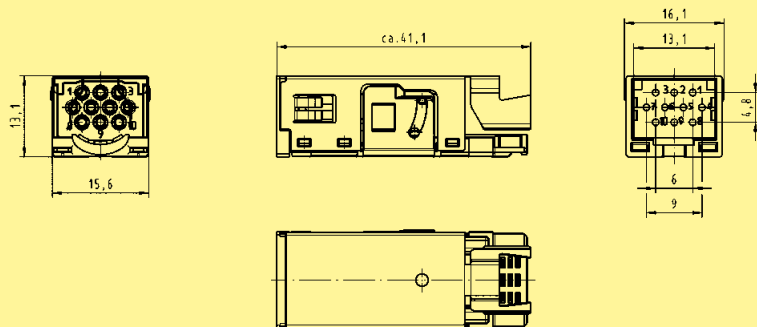

D-Sub crimp contacts

(Device side)
for AWG 24-20; 0.25-0.56 mm²
for AWG 22-18; 0.33-0.82 mm²

09 67 000 8576¹⁾
09 67 000 3576¹⁾

¹⁾ To be used with crimp tool 09 99 000 0501. Suitable locator: 61 03 600 0531

Identification	Part No.	Drawing	Dimensions in mm
<p>Han® PushPull panel feed-through HIFF to hold the 10-poles insert</p> <p>Metal rectangular</p>	<p>09 35 012 0311</p>		
<p>Metal circular</p>	<p>09 35 012 0312</p>		
<p>Plastic rectangular</p>	<p>09 35 012 0331</p>		
<p>D-Sub crimp contacts (Connector side) for AWG 24-20; 0.25-0.56 mm² for AWG 22-18; 0.33-0.82 mm²</p>	<p>09 67 000 8476¹⁾ 09 67 000 3476¹⁾</p>		

¹⁾ To be used with crimp tool 09 99 000 0501. Suitable locator: 61 03 600 0531



Han® PushPull, type acc. to IEC 61 076-3-117 variant 14
10-poles 50 V / 5 A

Features

- HARTING PushPull technology
- For the transmission of analog, low voltage and bus signals
- Fully shielded
- 10 contacts
- Touch-proof
- Easy and fast cable installation

Technical characteristics

Locking	PushPull technology acc. to IEC 61 076-3-117 variant 14
Degree of protection	IP 65 / IP 67
Mating face	acc. to IEC/PAS 61 076-3-11x
Number of contacts	10
Electrical data acc. to DIN EN 61 984	5 A 50 V 1.5 kV 3
Contact resistance	10 mΩ
Termination	Crimp
Conductor cross section	AWG 24 ... 18; 0.25 ... 0.82 mm ²
Conductor diameter	max. 2.1 mm
Outer cable diameter	6.5 ... 9.5 mm / 4 ... 11 mm
Shielding	Fully shielded, 360° shielding contact
Mating cycles	min. 500
Temperature range	-40 °C ... +70 °C
Housing material	Plastic, black Zinc die-cast, nickel-plated
Flammability acc. to UL 94	V0

Identification	Part No.	Drawing	Dimensions in mm
----------------	----------	---------	------------------

Han® PushPull Signal

Connector set 10-poles
incl. metal housing
and female insert
4 ... 11 mm

09 35 261 0401

Connector set 10-poles
incl. plastic housing
and female insert
6.5 ... 9.5 mm

09 35 261 0421

Order D-Sub crimp female
contacts separately

D-Sub crimp contacts

(Connector side)
for AWG 24-20; 0.25-0.56 mm²
for AWG 22-18; 0.33-0.82 mm²

09 67 000 8278¹⁾
09 67 000 3476²⁾

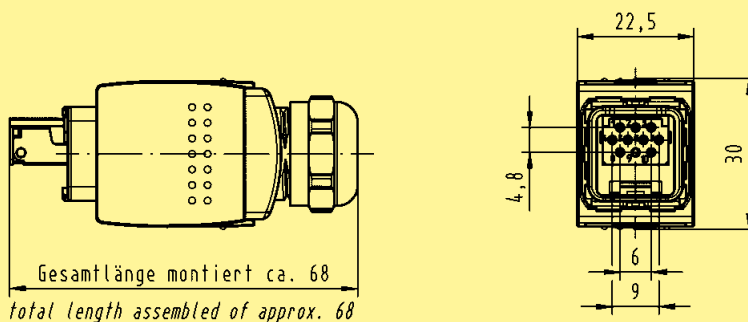

¹⁾ To be used with crimp tool 09 99 000 0175
²⁾ To be used with crimp tool 09 99 000 0501. Suitable locator: 61 03 600 0531



Han® PushPull, type acc. to IEC 61 076-3-118
Housing bulkhead mounting and power females for device integration

Features

- HARTING PushPull technology
- Compact, space-saving design
- Touch-proof
- Device side: male
 - Solder variant, angled and straight
- 4 times coding without contact loss

Technical characteristics

Locking	PushPull technology acc. to IEC 61 076-3-118
Degree of protection	IP 65 / IP 67
Number of contacts	4 + PE
Electrical data acc. to DIN EN 61 984	16 A 230/400 V 4 kV 3
Termination	Male insert with solder termination
Mating cycles	min. 500
Temperature range	-40 °C ... +70 °C
Housing material	Plastic, black
Flammability acc. to UL 94	V0

Identification

Part No.

Drawing

Dimensions in mm

Components device side

Housing bulkhead mounting
plastic

09 35 002 0323

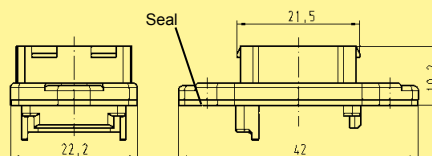

Panel cut out

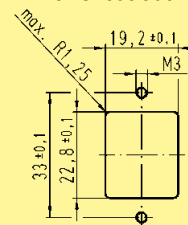

Dust protection cover IP 40,
rubber (NBR)

09 35 002 5401

Protection cover IP 65 / IP 67

09 35 002 5402

Coding pins

09 35 000 6190

Male insert
with solder termination
angled

09 35 002 3003

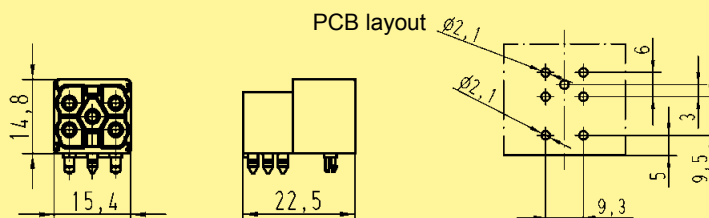

Male insert
with solder termination
straight

09 35 002 3004

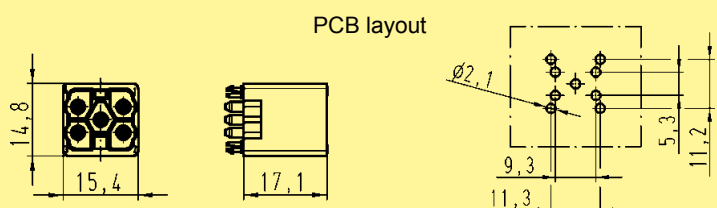



PushPull



Han® PushPull, type acc. to IEC 61 076-3-118
Panel feed-through, 5-poles, 230/400 V, 16 A

Features

- HARTING PushPull technology
- Compact, space-saving design
- Touch-proof
- Panel feed-through: male
 - crimp termination
 - Han-Quick Lock® termination technology
- 4 times coding without contact loss
- NEW: Larger termination cross section for conductors 0.25 - 1.5 mm²

Technical characteristics

Locking	PushPull technology acc. to IEC 61 076-3-117 variant 14
Mating face	acc. to IEC 61 076-3-118
Degree of protection	IP 65 / IP 67
Number of contacts	4 + PE
Electrical data	
acc. to DIN EN 61 984	16 A 690 V 4 kV 3
Termination cross section	0.25 – 2.5 mm ²
Mating cycles	min. 500
Temperature range	-40 °C ... +70 °C
Housing material	Plastic, black
Flammability acc. to UL 94	V0

Identification	Part No.	Drawing	Dimensions in mm
----------------	----------	---------	------------------

Han® PushPull Power 4/0 Panel feed-through

5-poles, 690 V / 16 A
incl. bulkhead housing and male insert

with crimp termination
(Order crimp male contacts separately)

09 35 231 0331

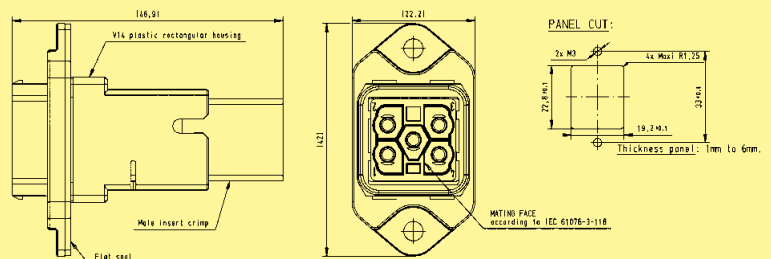

with Han-Quick Lock® termination

0.5 ... 2.5 mm²
0.25 ... 1.5 mm²

09 35 232 0331
09 35 234 0331

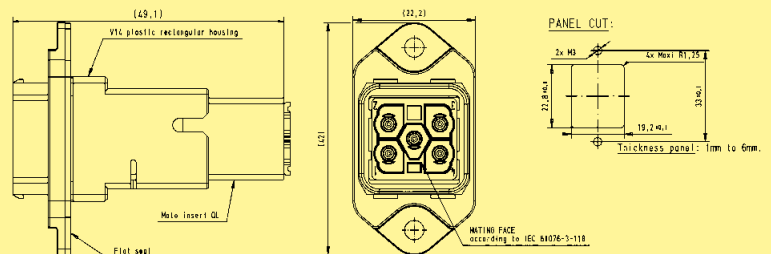

Coding element

10 pieces each for device and cable side
enables 4 times coding without contact loss

09 35 000 6190

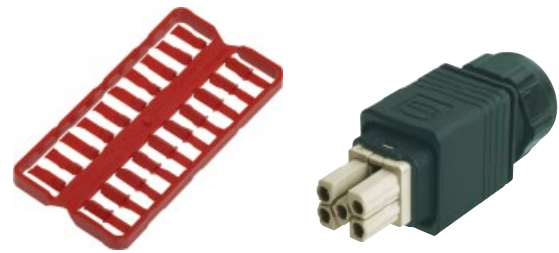

PushPull

Han® PushPull, type acc. to IEC 61 076-3-118
Connector, 5-poles, 230/400 V, 16 A

Features

- HARTING PushPull technology
- Compact, space-saving design
- Touch-proof
- Cable side: female
 - crimp termination
 - Han-Quick Lock® termination technology
 Field-assembly without special tools
- 4 times coding without contact loss
- NEW: Larger termination cross section for conductors 0.25 - 1.5 mm²

Technical characteristics

Locking	PushPull technology acc. to IEC 61 076-3-117 variant 14 acc. to IEC 61 076-3-118
Mating face	acc. to IEC 61 076-3-118
Degree of protection	IP 65 / IP 67
Number of contacts	4 + PE
Electrical data	16 A 690 V 4 kV 3
acc. to DIN EN 61 984	0.25 – 2.5 mm ²
Termination cross section	min. 500
Mating cycles	-40 °C ... +70 °C
Temperature range	Plastic, black
Housing material	V0
Flammability acc. to UL 94	

Identification	Part No.	Drawing	Dimensions in mm
----------------	----------	---------	------------------

Connector set, plastic

incl. housing and female insert

with crimp termination
9 – 13 mm clamp range
Han® P crimp contacts
order separately

09 35 231 0423

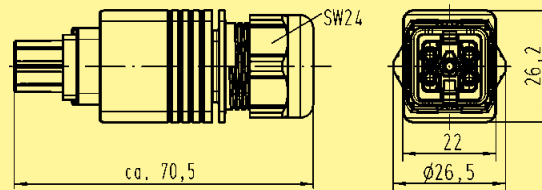

with Han-Quick Lock® termination
9 – 13 mm clamp range
for termination cross section 0.5 - 2.5 mm²

09 35 232 0423

with Han-Quick Lock® termination
6.5 – 9.5 mm clamp range
for termination cross section 0.5 - 2.5 mm²
for termination cross section 0.25 - 1.5 mm²

09 35 232 0421
09 35 234 0421

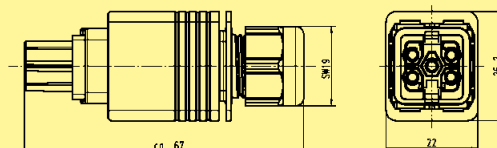

Dust protection cover IP 40

09 35 002 5412

Protection cover IP 65 / IP 67

09 35 002 5411

Coding pins

09 35 000 6190



Han® PushPull, type acc. to IEC 61 076-3-118
Housing bulkhead mounting and power females for device integration

Features

- HARTING PushPull technology
- Compact, space-saving design
- Touch-proof
- Device side: male
 - Solder variant, angled and straight
- 4 times coding without contact loss

Technical characteristics

Locking	PushPull technology acc. to IEC 61 076-3-118
Degree of protection	IP 65 / IP 67
Number of contacts	4 + PE
Electrical data acc. to DIN EN 61 984	16 A 230/400 V 4 kV 3
Termination	Male insert with solder termination
Mating cycles	min. 500
Temperature range	-40 °C ... +70 °C
Flammability acc. to UL 94	V0
Housing material	Zinc die-cast, nickel plated Plastic, black (female)

Identification	Part No.	Drawing	Dimensions in mm
----------------	----------	---------	------------------

Components device side

Housing bulkhead mounting metal	09 35 002 0303	
Dust protection cover IP 40, rubber (NBR)	09 35 002 5401	
Protection cover IP 65 / IP 67	09 35 002 5402	
Coding pins	09 35 000 6190	
Male insert with solder termination angled	09 35 002 3003	
Male insert with solder termination straight	09 35 002 3004	

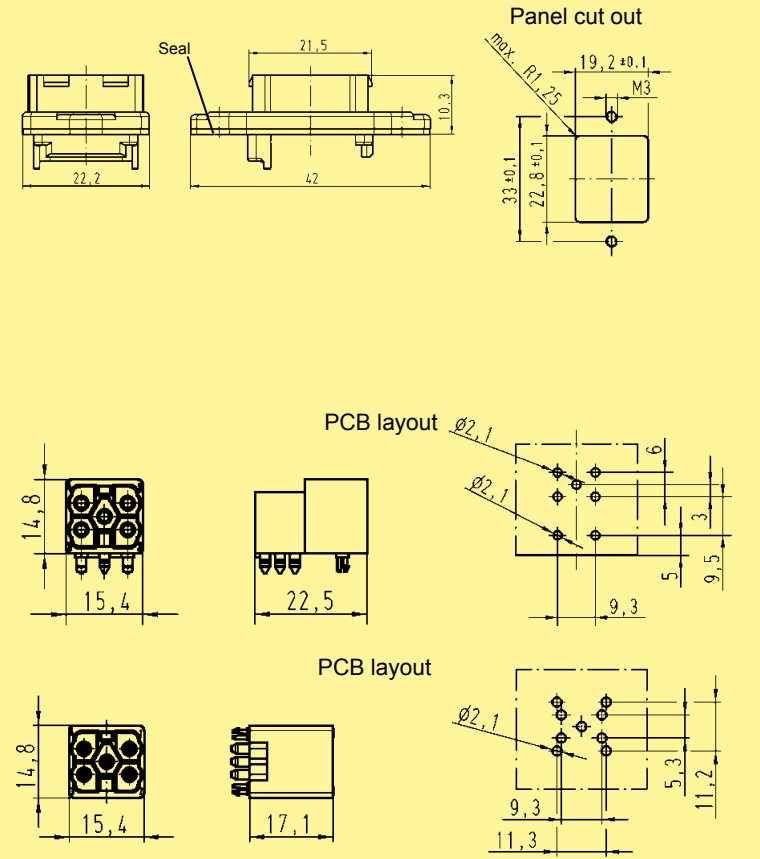



Han® PushPull, type acc. to IEC 61 076-3-118
Panel feed-through, 5-poles, 16 A

Features

- HARTING PushPull technology
- Compact, space-saving design
- Touch-proof
- Panel feed-through: male
 - crimp termination
 - Han-Quick Lock® termination technology
- 4 times coding without contact loss
- NEW: Larger termination cross section for conductors 0.25 - 1.5 mm²

Technical characteristics

Locking	PushPull technology acc. to IEC 61 076-3-117 variant 14 acc. to IEC 61 076-3-118
Mating face	acc. to IEC 61 076-3-118
Degree of protection	IP 65 / IP 67
Number of contacts	4 + PE
Electrical data	16 A 690 V 4 kV 3
acc. to DIN EN 61 984	0.25 – 2.5 mm ²
Termination cross section	min. 500
Mating cycles	-40 °C ... +70 °C
Temperature range	Zinc die-cast, nickel-plated
Housing material	V0
Flammability acc. to UL 94	

Identification	Part No.	Drawing	Dimensions in mm
----------------	----------	---------	------------------

Han® PushPull Power 4/0
Panel feed-through
5-poles, 690 V / 16 A
incl. bulkhead housing and male insert

Rectangular panel cut out
with crimp termination
(Order crimp male contacts separately)

09 35 231 0311

with Han-Quick Lock® termination

0.5 ... 2.5 mm²
0.25 ... 1.5 mm²

09 35 232 0311
09 35 234 0311

Circular panel cut out
with crimp termination
(Order crimp male contacts separately)

09 35 231 0312

with Han-Quick Lock® termination

0.5 ... 2.5 mm²
0.25 ... 1.5 mm²

09 35 232 0312
09 35 234 0312

Coding element

10 pieces each for device and cable side
enables 4 times coding without contact loss

09 35 000 6190

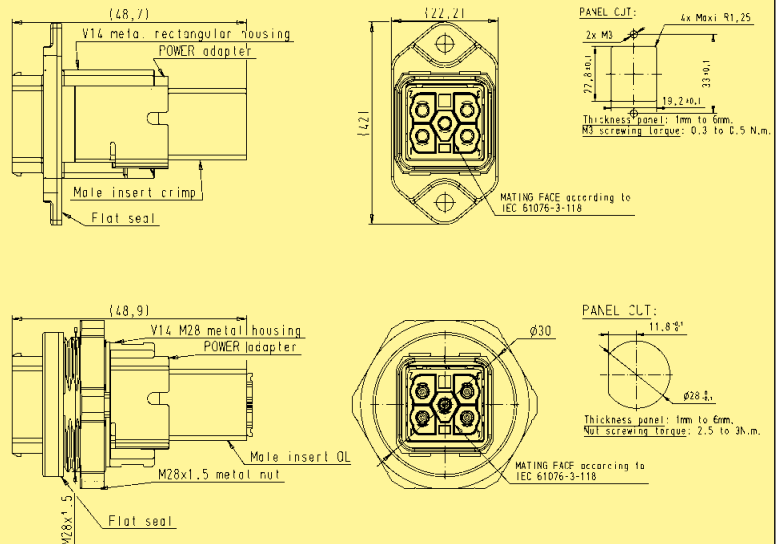



Han® PushPull, type acc. to IEC 61 076-3-118
Connector, 5-poles, 16 A

Features

- HARTING PushPull technology
- Compact, space-saving design
- Touch-proof
- Cable side: female
 - crimp termination
 - Han-Quick Lock® termination technology
 Field-assembly without special tools
- 4 times coding without contact loss
- NEW: Larger termination cross section for conductors 0.25 - 1.5 mm²

Technical characteristics

Locking	PushPull technology acc. to IEC 61 076-3-117 variant 14 acc. to IEC 61 076-3-118
Mating face	acc. to IEC 61 076-3-118
Degree of protection	IP 65 / IP 67
Number of contacts	4 + PE
Electrical data	16 A 690 V 4 kV 3
acc. to DIN EN 61 984	0.25 – 2.5 mm ²
Termination cross section	min. 500
Mating cycles	-40 °C ... +70 °C
Temperature range	Zinc die-cast, nickel-plated
Housing material	V0
Flammability acc. to UL 94	

Identification	Part No.	Drawing	Dimensions in mm
----------------	----------	---------	------------------

Connector set, metal

incl. housing and female insert

with crimp termination
4 – 11 mm clamp range
Han® P crimp contacts
order separately

09 35 231 0401

with Han-Quick Lock® termination
4 – 11 mm clamp range
for termination cross section 0.5 - 2.5 mm²
for termination cross section 0.25 - 1.5 mm²

09 35 232 0401
09 35 234 0401

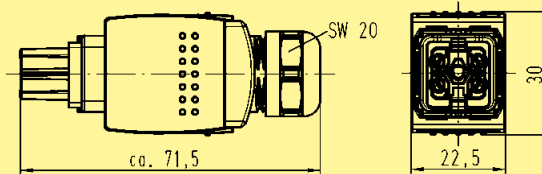

Dust protection cover IP 40 09 35 002 5412

Protection cover IP 65 / IP 67 09 35 002 5411

Coding pins 09 35 000 6190



Han® PushPull, type acc. to IEC 61 076-3-117 variant 14 cable to cable housing

Features

- HARTING PushPull technology
- Ideal for prototyping
- Can be combined with panel feed-throughs for power, data and signal

Technical characteristics

Locking	PushPull technology acc. to IEC 61 076-3-117 variant 14
Degree of protection	IP 65 / IP 67
Outer cable diameter	6.5 ... 9.5 mm / 9 ... 13 mm
Mating cycles	min. 750
Temperature range	-40 °C ... +70 °C
Housing material	Plastic, black
Flammability acc. to UL 94	V0

Identification	Part No.	Drawing	Dimensions in mm
----------------	----------	---------	------------------

Han® PushPull cable to cable housings, plastic
(Order housing bulkhead mounting and insert separately)

for outer cable diameter 6.5 ... 9.5 mm

09 35 002 0431

for outer cable diameter 9 ... 13 mm

09 35 002 0433

Suitable bulkhead housing, plastic

for power, 5-poles, 690 V / 16 A, incl. housing bulkhead mounting and insert

with crimp termination (Order Han® P crimp male contacts separately)

09 35 231 0331

with Han-Quick Lock® termination

0.5 ... 2.5 mm²

09 35 232 0331

0.25 ... 1.5 mm²

09 35 234 0331

Coding element power

10 pieces each for device and cable side

09 35 000 6190

2X REMFORM $\phi 3 \times 8$ TORX screws

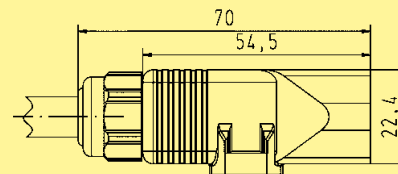
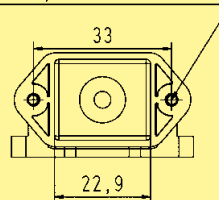

2X REMFORM $\phi 3 \times 8$ TORX screws

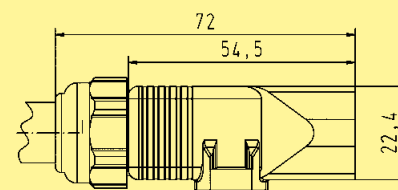
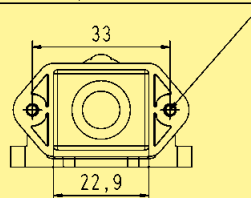



PushPull

Housing bulkhead mounting and power females for device integration

Features

- HARTING PushPull technology
- Touch-proof
- Device side: male
 - Solder variant, angled and straight
- AIDA-conform (German Domestic Automobile Manufactures)

Technical characteristics

Locking	PushPull technology
Degree of protection	IP 65 / IP 67
Number of contacts	4 + PE
Electrical data	
acc. to DIN EN 61 984	16 A 24 V 4 kV 3
Termination	Male insert with solder termination
Mating cycles	min. 500
Temperature range	-40 °C ... +70 °C
Housing material	Plastic, black
Flammability acc. to UL 94	V0

Identification

Part No.

Drawing

Dimensions in mm

Components device side

Housing bulkhead mounting plastic

09 35 004 0321

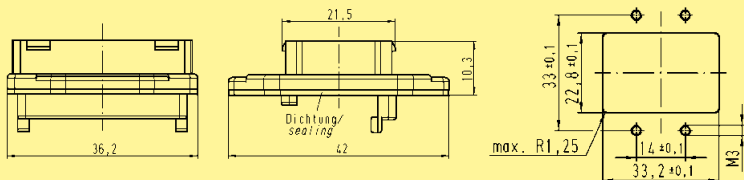

Male insert with solder termination angled

09 35 004 3003

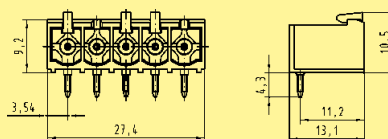

Male insert with solder termination straight

09 35 004 3004

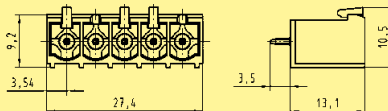

Panel feed-through, plastic
incl. housing and male insert with spring force connection

09 35 431 0331

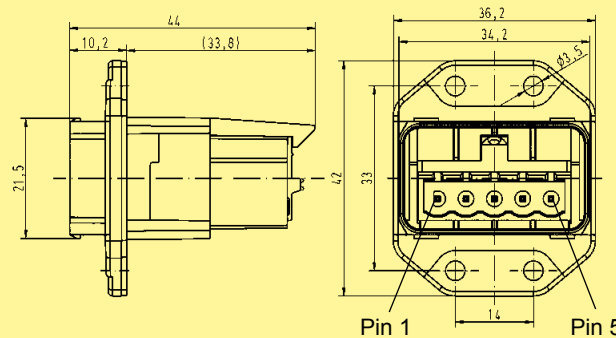

Protection cover IP 65 / IP 67

09 35 004 5401



Connector, 5-poles, 24 V, 16 A

Features

- HARTING PushPull technology
- Touch-proof
- Cable side: female
 - spring force connection
- AIDA-conform
(German Domestic Automobile Manufactures)

Technical characteristics

Locking	PushPull technology
Degree of protection	IP 65 / IP 67
Number of contacts	4 + PE
Electrical data	
acc. to DIN EN 61 984	16 A 24 V 4 kV 3
Termination	Spring force connection
Termination cross section	0.75 ... 2.5 mm ²
Mating cycles	min. 500
Temperature range	-40 °C ... +70 °C
Cable diameter	9 – 13 mm
Housing material	Plastic, black
Flammability acc. to UL 94	V0

Identification

Part No.

Drawing

Dimensions in mm

Connector set, plastic

incl. housing
and female insert
with spring force connection

09 35 431 0421

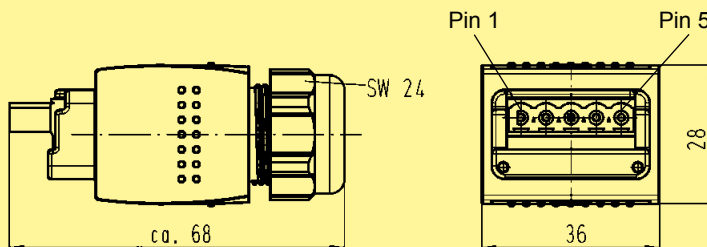



Housing bulkhead mounting and power females for device integration

Features

- HARTING PushPull technology
- Touch-proof
- Device side: male
 - Solder variant, angled and straight
- AIDA-conform (German Domestic Automobile Manufactures)

Technical characteristics

Locking	PushPull technology
Degree of protection	IP 65 / IP 67
Number of contacts	4 + PE
Electrical data	16 A 24 V 4 kV
acc. to DIN EN 61 984	Male insert with solder termination
Termination	min. 500
Mating cycles	-40 °C ... +70 °C
Temperature range	Zinc die-cast, nickel plated
Housing material	Plastic, black (female)

Identification

Part No.

Drawing

Dimensions in mm

Components device side

Housing bulkhead mounting metal

09 35 004 0301

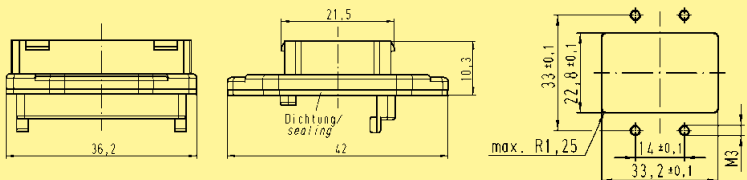

Male insert with solder termination angled

09 35 004 3003

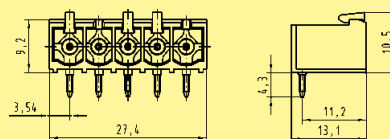

Male insert with solder termination straight

09 35 004 3004

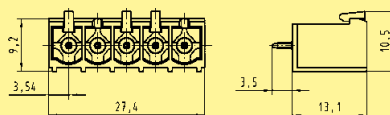

Panel feed-through, metal

incl. housing and male insert with spring force connection and with fixed coding

09 35 431 0311

with variable coding

09 35 431 0313

Protection cover IP 65 / IP 67

09 35 004 5401

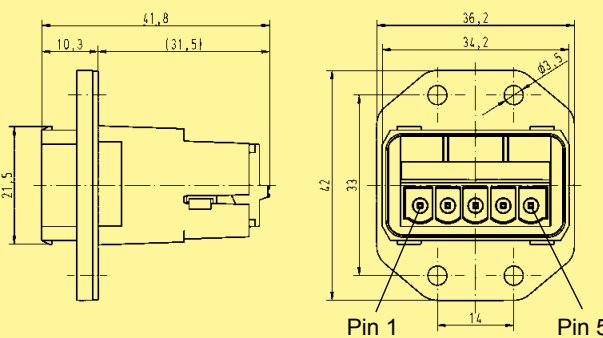



Han® PushPull L Power 4/0 Genderchanger Metal

Features

- High degree of protection IP 65 / IP 67
- Robust metal housing
- Standard PROFINET component of the German automotive production
- Allows usage of different cable types (Type B,C) e.g. in robots application
- Extension of cords according to PROFINET guideline

Technical characteristics

Connector	Han® PushPull L Power 4/0
Locking	PushPull technology
Electrical transmission	16 A / 24 V
Number of contacts	5
Mating cycles	min. 500
Housing material	Aluminium anodized
Dimensions	83.4 x 62 x 40.7 mm (unmated)
Degree of protection acc. to DIN 60529	IP 65 / IP 67 (mated)
Mounting	Wall mountable with 4 screws (type M5)
Temperature range	-20 °C ... +50 °C
Maximum permissible humidity	30 % ... 95 % (no condensation)

Identification

Part No.

Drawing

Dimensions in mm

Han® PushPull L Power 4/0 Genderchanger metal

including housing and printed board with 2 x male insert with solder termination

09 35 431 0501

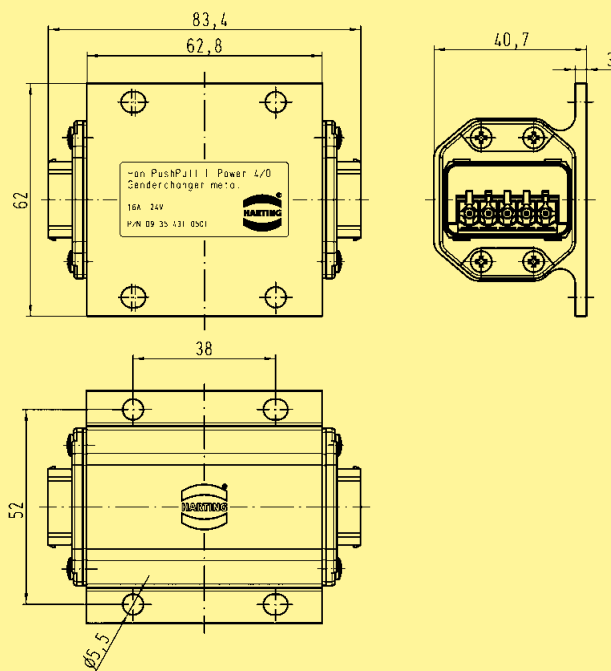



Han® PushPull L Power 4/0 Coupling Metal

Features

- High degree of protection IP 65 / IP 67
- Robust metal housing
- Standard PROFINET component of the German automotive production
- Extension of cords according to PROFINET guideline
- For an easy robot termination and a fast exchange of tube packages

Technical characteristics

Locking	PushPull technology
Electrical transmission	16 A / 24 V
Number of contacts	5
Mating cycles	min. 500
Housing material	Aluminium die-cast
Degree of protection acc. to DIN 60529	IP 65 / IP 67
Temperature range	-40 °C ... +70 °C

Identification

Part No.

Drawing

Dimensions in mm

Han® PushPull L Power 4/0 Coupling metal

including housing, contact insert Power L, bulkhead housing and cable gland

61 04 201 1085

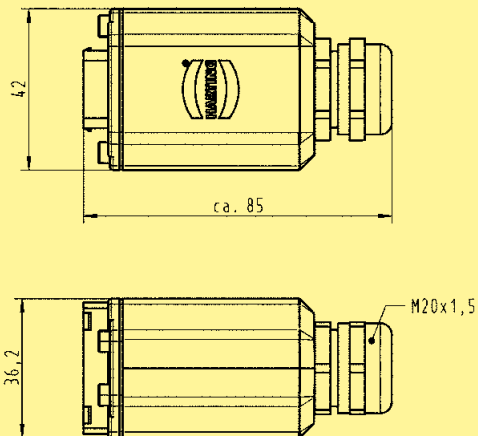

Fixing flange

61 04 600 0183

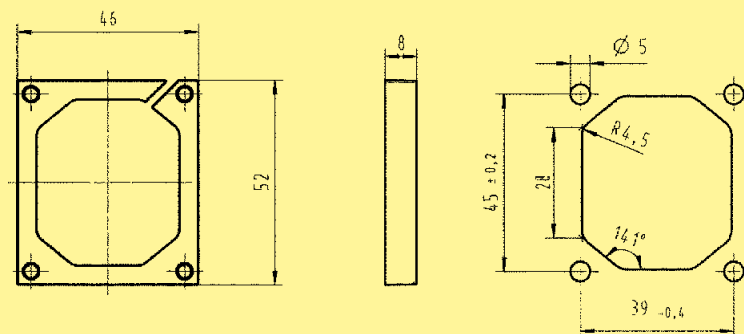



Connector, 5-poles, 24 V, 16 A

Features

- HARTING PushPull technology
- Touch-proof
- Cable side: female
 - spring force connection
- AIDA-conform
(German Domestic Automobile Manufactures)

Technical characteristics

Locking	PushPull technology
Degree of protection	IP 65 / IP 67
Number of contacts	4 + PE
Electrical data	
acc. to DIN EN 61 984	16 A 24 V 4 kV 3
Termination	Spring force connection
Termination cross section	0.75 ... 2.5 mm ²
Mating cycles	min. 500
Temperature range	-40 °C ... +70 °C
Cable diameter	9 – 13 mm
Housing material	Zinc die-cast, nickel plated

Identification

Part No.

Drawing

Dimensions in mm

Connector set, metal

incl. housing
and female insert
with spring force connection

09 35 431 0401

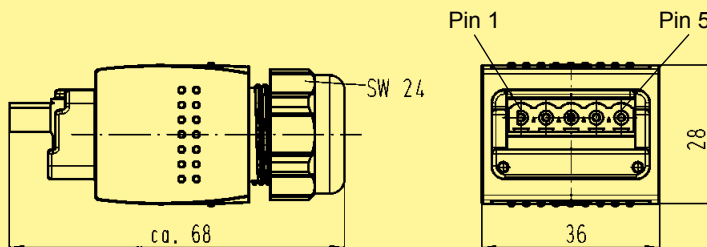

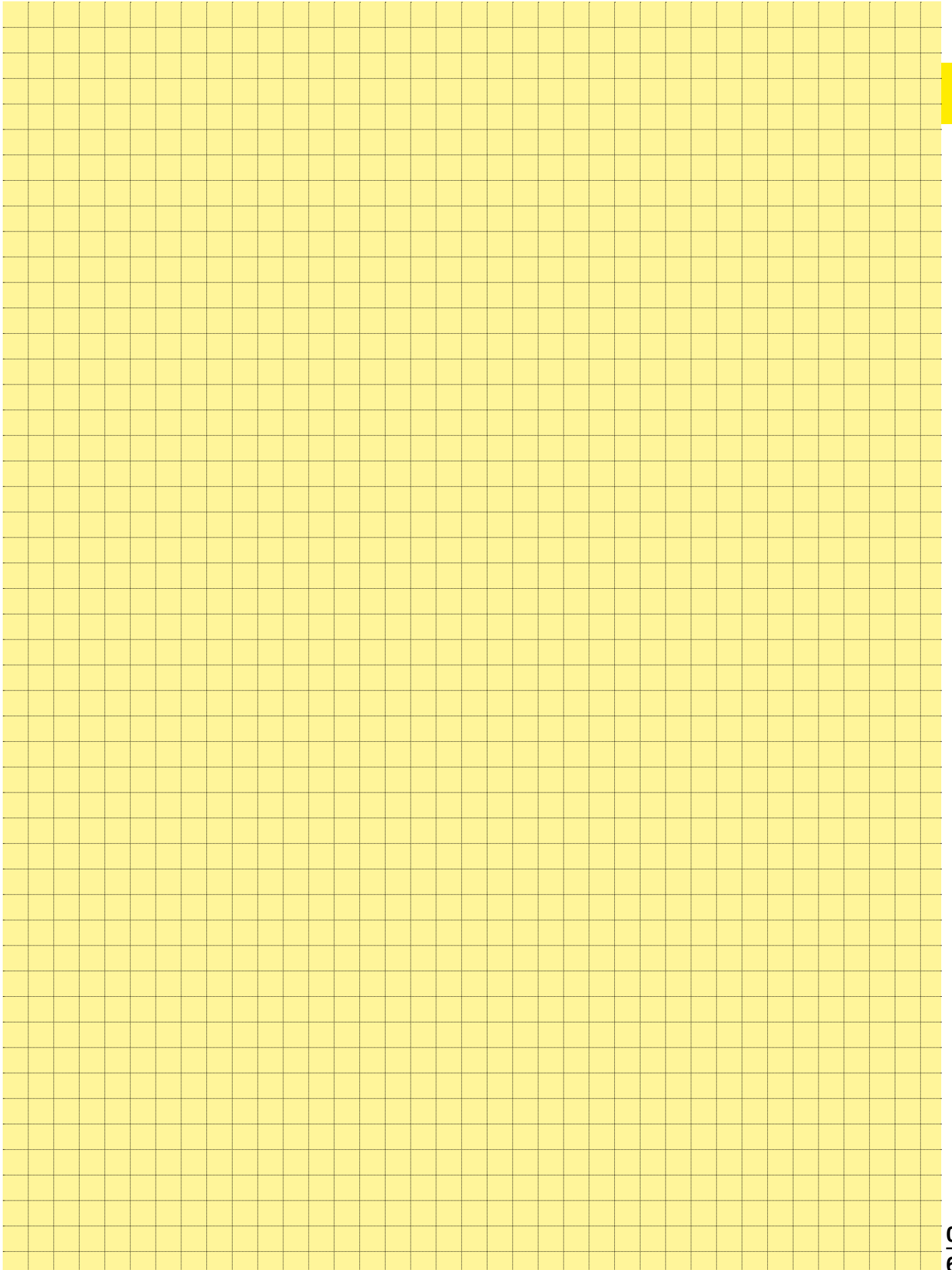

X-ON Electronics

Largest Supplier of Electrical and Electronic Components

Click to view similar products for [harting manufacturer](#):

Other Similar products are found below :

[73550400915](#) [9120052633](#) [9185106813](#) [9200165425](#) [9300160306](#) [9300165422](#) [9300245422](#) [11996000001](#) [14010313110334](#)
[14010813101333](#) [14011213102333](#) [14110213002333](#) [15110102601333](#) [15210262401000](#) [15211002601333](#) [15221002401000](#)
[15250682601333](#) [15150082601333](#) [15150122601333](#) [15150262601333](#) [15220062401000](#) [15220122601000](#) [15220502401000](#)
[15220682401000](#) [15250102601333](#) [15250122601333](#) [17063082203](#) [19000007106](#) [19000007109](#) [19200100290](#) [19200100295](#) [19200100546](#)
[19200320537](#) [19300060292](#) [19300060546](#) [19300067296](#) [19300101430](#) [19300101440](#) [19300101730](#) [19300160757](#) [19300241291](#)
[19300320427](#) [19300480449](#) [1930060291](#) [19302100291](#) [19302100547](#) [19302101250](#) [19302101541](#) [19302161251](#) [19302161291](#)