

Customer Information Sheet

DRAWING No.: M83-LMT2M3NXX-0000-000

SHEET 2 OF 2

IF IN DOUBT - ASK

©

NOT TO SCALE

THIRD ANGLE PROJECTION

ALL DIMENSIONS IN mm

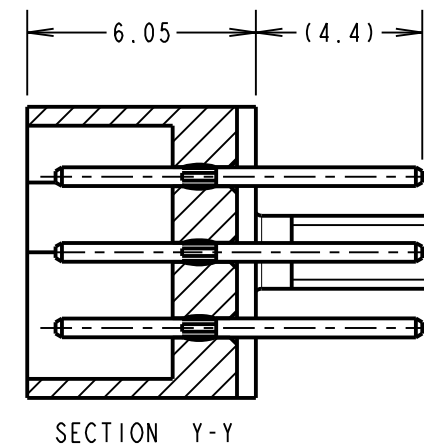
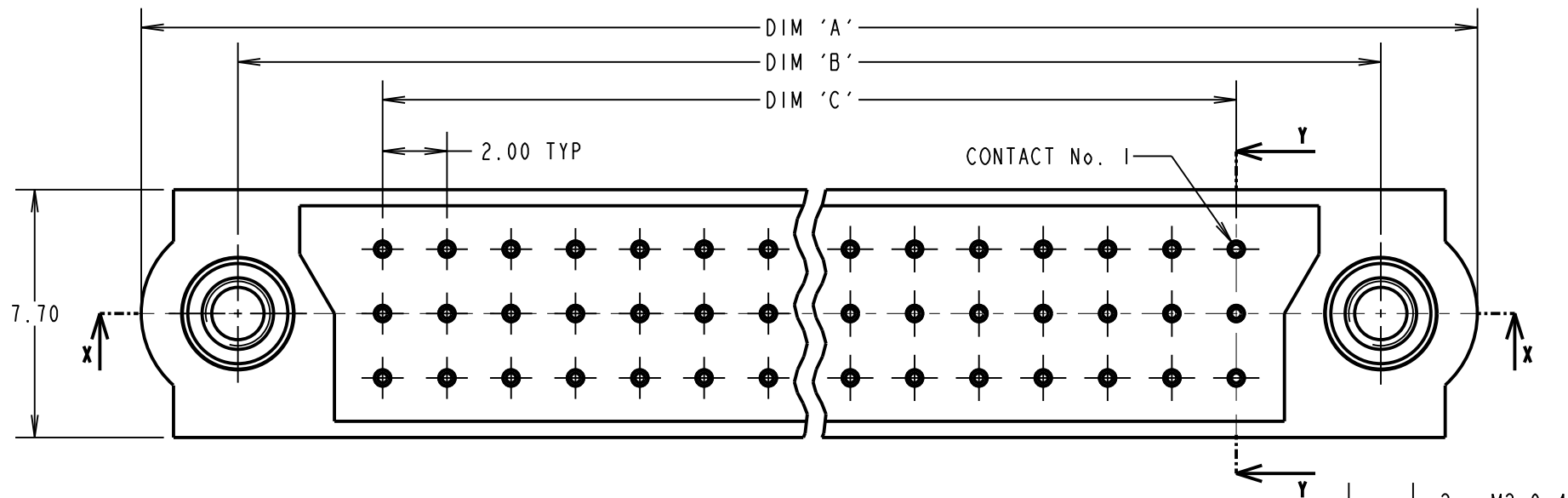

SPECIFICATIONS:

- MATERIAL:**
 MOULDING = GLASS-FILLED PPS, UL94V-0, BLACK
 JACKSCREW = STAINLESS STEEL
 CONTACT = PHOSPHOR BRONZE
- FINISH:**
 CONTACT = 0.75µ GOLD
- ELECTRICAL:**
 CURRENT RATING AT 25°C = 3.0A MAX
 CURRENT RATING AT 85°C = 2.2A MAX
 CONTACT RESISTANCE = 25mΩ MAX
 WORKING VOLTAGE = 120V AC/DC
 VOLTAGE PROOF = 360V AC/DC
 INSULATION RESISTANCE = 100MΩ MIN
- MECHANICAL:**
 DURABILITY = 500 OPERATIONS
- ENVIRONMENTAL:**
 TEMPERATURE RANGE = -55°C TO +125°C
- PACKING:**
 TRAY
 BOARD MOUNT NUTS PACKED SEPERATELY IN A BAG

FOR COMPLETE SPECIFICATION, SEE COMPONENT SPECIFICATION C005XX (LATEST ISSUE)

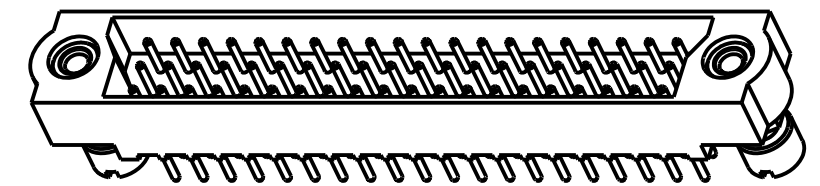
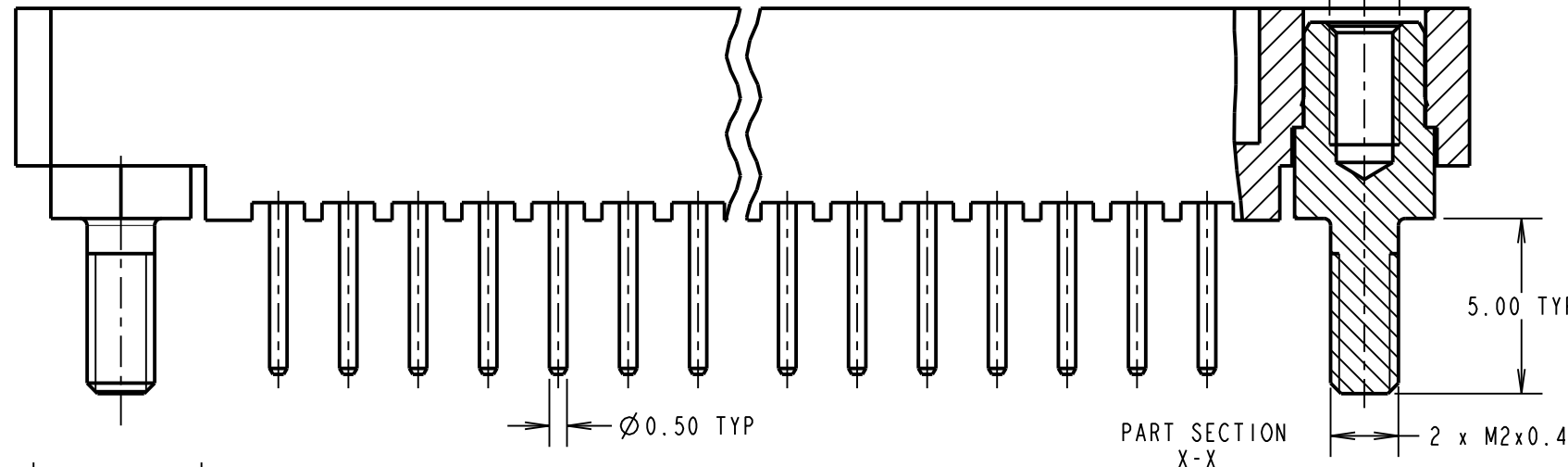

CONNECTORS SHOWN FULLY ASSEMBLED FOR ILLUSTRATION PURPOSES ONLY

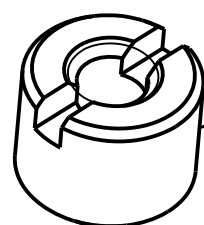
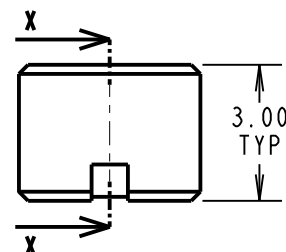
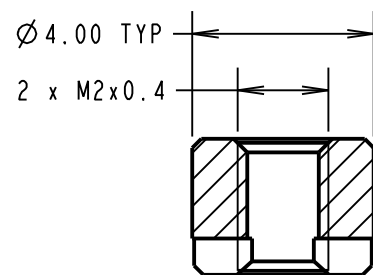

2 x BOARD MOUNT NUT

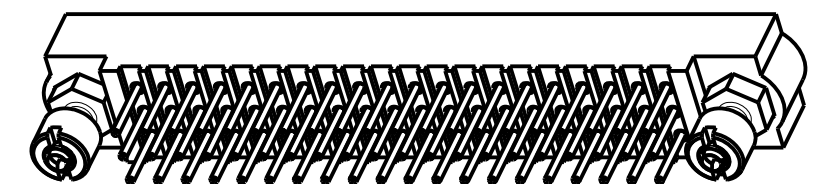

ORDER CODE:
M83-LMT2M3NXX-0000-000

TOTAL No. OF CONTACTS
 18, 27, 36, 54, 60, 63, 72, 96

DIMENSION	CALCULATION
DIM 'A'	((TOTAL No. OF CONTACTS / 3) x 2) + 13
DIM 'B'	((TOTAL No. OF CONTACTS / 3) x 2) + 7
DIM 'C'	((TOTAL No. OF CONTACTS / 3) x 2) - 2
EXAMPLE: CONNECTOR WITH 27 CONTACTS, M83-LMT2M3N27-0000-000 DIM 'A' = 31.00, DIM 'B' = 25.00, DIM 'C' = 16.00	

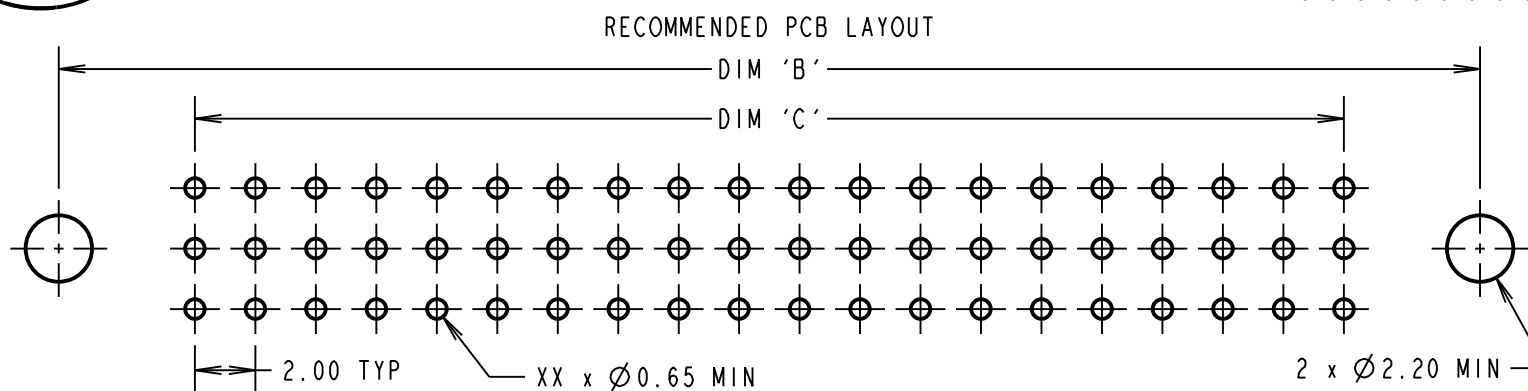

SB	2	06.02.12	11638
NAME	ISS.	DATE	C/NOTE
APPROVED: S.BENNETT			
CHECKED: S.FLOWER			
DRAWN: S. MCCULLAGH			
CUSTOMER REF.:			
ASSEMBLY DRG:			

HARWIN
 www.harwin.com
 technical@harwin.com

THIS DRAWING AND ANY INFORMATION OR DESCRIPTIVE MATTER SET OUT HEREON ARE CONFIDENTIAL AND COPYRIGHT PROPERTY OF THE HARWIN GROUP AND MUST NOT BE DISCLOSED, LOANED, COPIED OR USED FOR MANUFACTURING, TENDERING OR FOR ANY OTHER PURPOSE WITHOUT THEIR WRITTEN PERMISSION.

TOLERANCES
 X. = ±1mm
 X.X = ±0.25mm
 X.XX = ±0.10mm
 X.XXX = ±0.01mm
 ANGLES = ±5°
 UNLESS STATED

MATERIAL:
 SEE ABOVE

FINISH:
 SEE ABOVE

S/AREA:
 mm²

TITLE: JACKSCREW DATAMATE
 3-ROW VERTICAL MALE PC TAIL ASSEMBLY

DRAWING NUMBER:
M83-LMT2M3NXX-0000-000

SHT 2 OF 2

X-ON Electronics

Largest Supplier of Electrical and Electronic Components

Click to view similar products for [Headers & Wire Housings](#) category:

Click to view products by [Harwin](#) manufacturer:

Other Similar products are found below :

[892-18-020-10-001101](#) [58102-G61-06LF](#) [582553-1](#) [0009485154](#) [009176003701906](#) [0050291907](#) [LY20-4P-DT1-P1E-BR](#) [02.125.8002.8](#)
[609-3404](#) [61062-3](#) [622-0430](#) [622-3653LF](#) [63453-116](#) [636-1030](#) [636-1427](#) [636-3427](#) [636-4007](#) [641938-9](#) [641991-4](#) [644827-2](#) [65817-010LF](#)
[65817-015LF](#) [65863-015LF](#) [66207-023LF](#) [67095-007LF](#) [67601157](#) [68648-049](#) [70.362.1628.0](#) [70-4210](#) [70-4226B](#) [70-4853B](#) [707-5020](#) [707-](#)
[5028](#) [71.350.2428.0](#) [71918-208LF](#) [71961-016LF](#) [733-134](#) [733-162](#) [754199-000](#) [760-3052](#) [787-8014-00](#) [79531-3000](#) [FCN-360C032-B](#) [FCN-](#)
[367T-T012/H](#) [FCN-723D010/2](#) [80.063.4001.1](#) [800-90-001-10-001000](#) [800-90-010-10-002000](#) [801-43-002-10-013000](#) [801-43-006-10-002000](#)