

HATCH LED DRIVERS

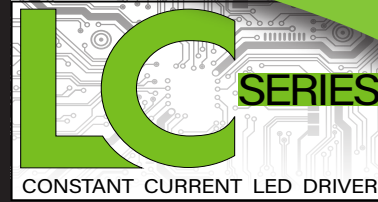

GENERAL INFORMATION

LED Driver Type	Constant Current (Class 2)
Maximum Wattage	16 Watts
Input Voltage	120 VAC ± 10% Dedicated 120 - 277 VAC ± 10% Universal
Input Frequency	50/60Hz
Total Harmonic Distortion	<20%

CASE STYLE Q: POLYCARBONATE



ELECTRICAL SPECIFICATIONS

Watts	Rated Current	Output Voltage	Dimming Type	Input Voltage	Input Power	Input Current	Power Factor	Efficiency	Hatch Part Number
16W	0-10V Dimming								
	350mA	15-46 VDC	0-10V Dimming	120-277 VAC	20W	0.19/0.09A	>0.90	83%	LC16-0350Z-UNV-Q ‡
	500mA	10-32 VDC	0-10V Dimming	120-277 VAC	20W	0.19/0.09A	>0.90	83%	LC16-0500Z-UNV-Q ‡
	700mA	10-23 VDC	0-10V Dimming	120-277 VAC	20W	0.19/0.09A	>0.90	83%	LC16-0700Z-UNV-Q ‡
	Phase Dimming								
	350mA	15-46 VDC	Phase Dimming	120 VAC	20W	0.19A	>0.90	80%	LC16-0350P-120-Q*
	500mA	10-32 VDC	Phase Dimming	120 VAC	20W	0.19A	>0.90	80%	LC16-0500P-120-Q
	700mA	7-23 VDC	Phase Dimming	120 VAC	20W	0.19A	>0.90	80%	LC16-0700P-120-Q
	1050mA	6-15 VDC	Phase Dimming	120 VAC	20W	0.19A	>0.90	80%	LC16-1050P-120-Q

‡Class P *Class 2 US Only

PRODUCT FEATURES

- Short circuit and overload protection
- Suitable for dry and damp locations
- Operating temperature range: -40°C to 90°C (measured at Tcase)
- Surge voltage rating: L-N 2kV, L/N-GND 4kV
- Withstanding Voltage: I/P - O/P 2.8kVDC, 2mA
- Output Current tolerance +/- 5% @ 25°C
- MTBF: 510,000 hrs (0-10V Dimming) @ 40°C ambient case temp
690,00 hrs (Phase Dimming) @ 40°C ambient case temp
- Inrush Current: <10A Max @230VAC for Universal input models
- 0-10 V dimming range: 10%-100%

APPROVALS

- UL 8750 recognized component / Class P
- EN61000-3-2
- EMC: Meets FCC47 CFR Part 15 (Class B) consumer limits
- IP66



Type HL



MECHANICAL SPECIFICATIONS: CASE STYLE Q

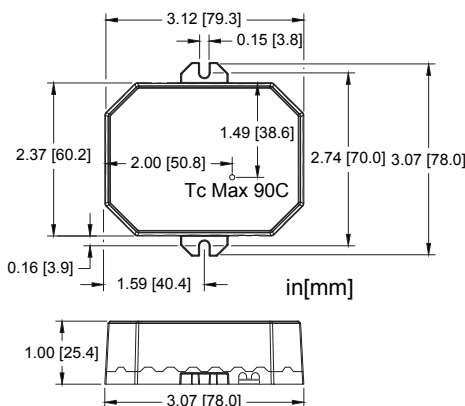

DIMENSIONS [IN/MM]

Length:	3.07 [78.0]
Mounting:	2.74 [69.6]
Width:	3.14 [79.8]
Height:	1.00 [25.4]

WIRING INFORMATION

Input:	12", Black (L), White (N) #18AWG
Output:	12", Red (+), Blue (-) #18AWG #22AWG (with Class 2 Output)
Dimming:	12", Purple (+), Grey (-) #22AWG

PACKAGING INFORMATION

Weight:	6.4 oz
Quantity:	50pc/carton

Specifications subject to change without notice.

PERFORMANCE CURVES

Efficiency VS Output Power

Efficiency vs. Output Power - 0-10V Dimming

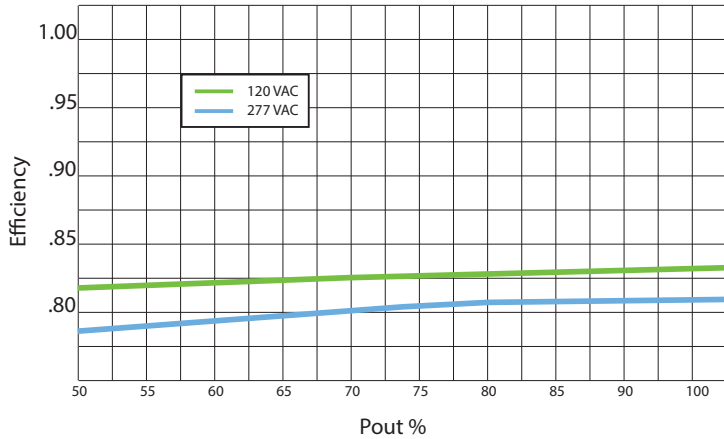

Power Factor VS Output Power

Power Factor vs. Output Power - 0-10V Dimming

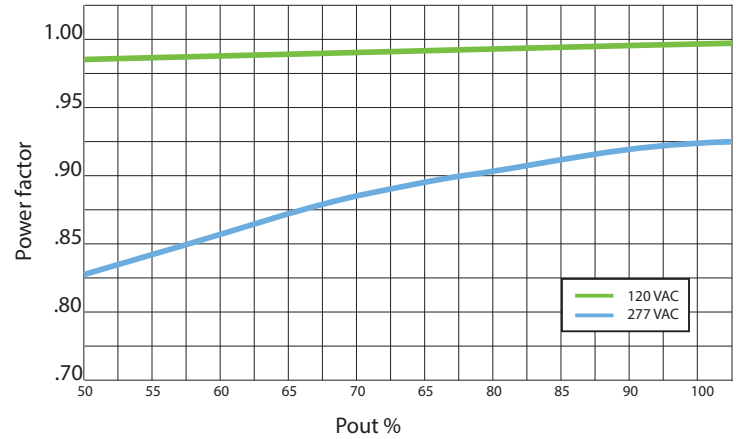

Efficiency vs. Output Power - Phase Dimming

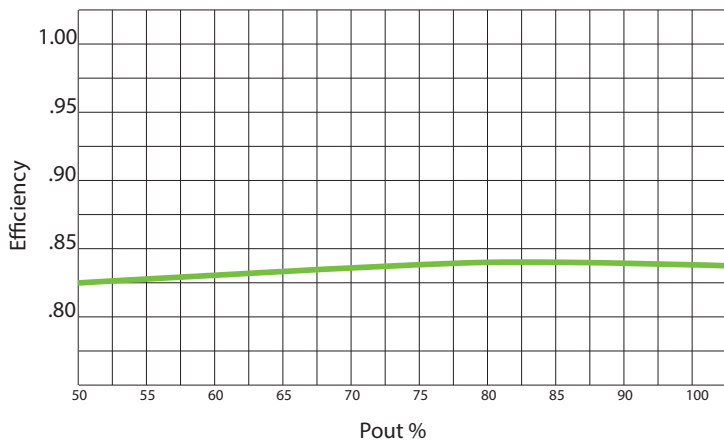

Power Factor vs. Output Power - Phase Dimming

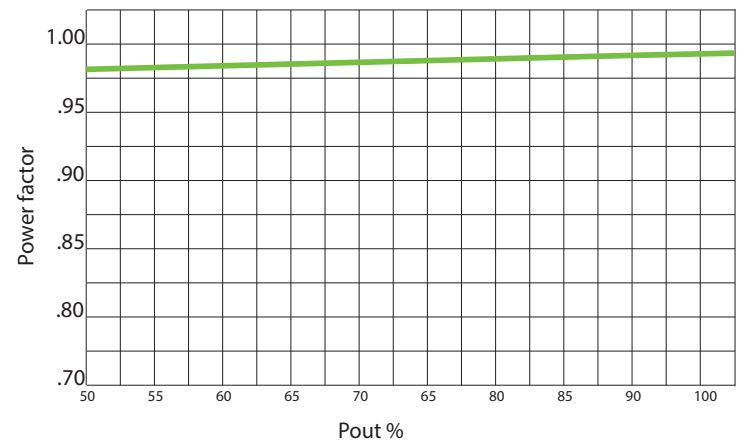

PERFORMANCE CURVES

THD VS Output Power

THD vs Output Power - Phase-Dimming

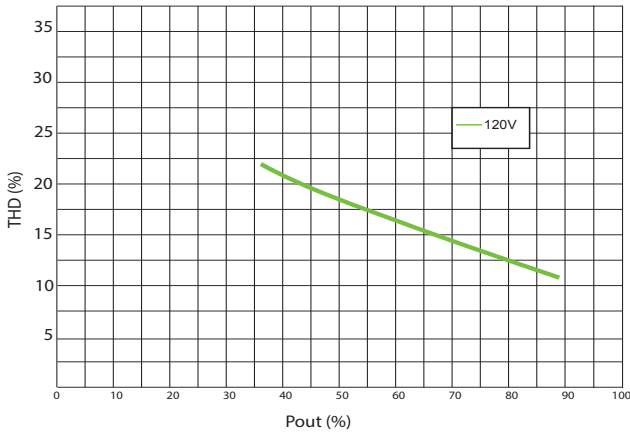

THD vs Output Power - 0-10V Dimming

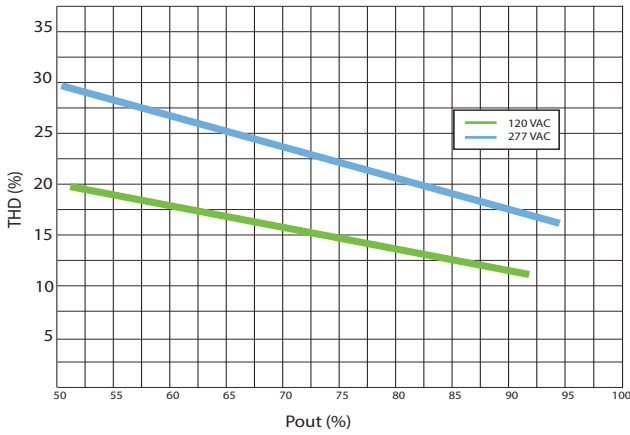

Dimming Curves

Dimming Curve - Phase Dimming

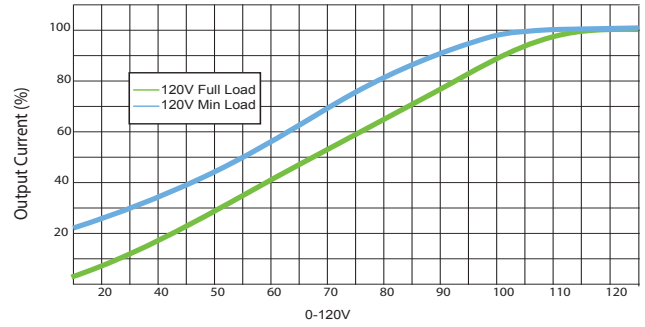

Dimming Curve - 0-10V Dimming

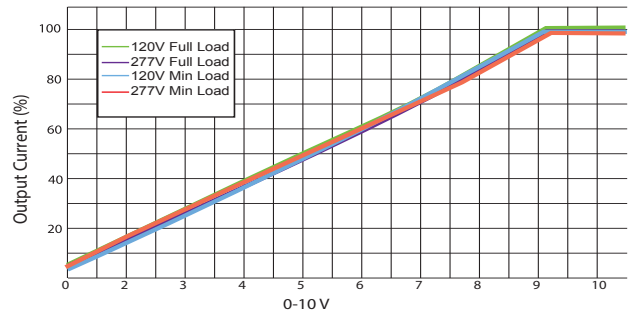

Lifetime VS Case Temperature

Lifetime vs. Case Temperature

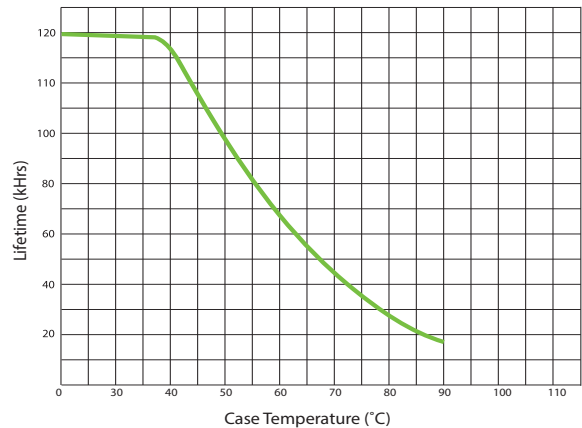

Specifications subject to change without notice.

X-ON Electronics

Largest Supplier of Electrical and Electronic Components

Click to view similar products for [LED Power Supplies](#) category:

Click to view products by [Hatch Lighting](#) manufacturer:

Other Similar products are found below :

[ESS015W-1000-12](#) [PDA-WIFI](#) [PIFC-K250F](#) [PITB-K222A](#) [ALD-514012PJ134](#) [LB240S24KH](#) [LMH020-SPLC-0000-0000001](#) [LMD600-0100-C1A7-7030000](#) [79534](#) [79535](#) [EUG-200S210DT](#) [ESS030W-1050-21](#) [ESS030W-0900-32](#) [BPOXL 4-12-035](#) [ESS010W-0350-24](#) [ESS010W-0200-42](#) [ESM060W-1400-42](#) [PDA080B-1A0G](#) [PDA150B-S1A5G](#) [SLM140W-1.05-130-ZA](#) [ESS015W-0700-18](#) [EUD-150S350DVA](#) [LWA320-C420-ARK-B](#) [HVG-240-48AB](#) [HVG-320-36AB](#) [HVG-320-54AB](#) [ELG-240-C1400AB](#) [EUK-150S105DV](#) [BXCS-12Z-N2P-B1-A](#) [BXPR-WN-01-A](#) [LN1224CV](#) [BXCS-12D-N2P-01-A](#) [BXCS-12W-N2P-01-A](#) [HBG-160-24AB](#) [980100001200394](#) [980060001200376](#) [LC 14W 250-350MA FLEXC R ADV2](#) [LC 24W 500-600MA FLEXC R ADV2](#) [LC 36W 850-900MA FLEXC R ADV2](#) [LC 18W 24V ONE4ALL SC PRE](#) [LC 50W 200-350ML 170V FLEXC LP SNC4](#) [LC 25W 200-350ML 70V FLEXC LP SNC4](#) [LC 35W 200-350ML 121V FLEXC LP SNC4](#) [LCBI 10W 350MA PHASE-CUT/1-10V LP](#) [LC 13W 300MA FIXC C SNC](#) [LC 10W 250MA FIXC SC SNC2](#) [LC 35W 800MA FIXC SR ADV2](#) [LC 38W 900MA FIXC SR ADV2](#) [LC 34W 800MA FIXC SC ADV2](#) [LC 44W 1050MA FIXC SC ADV2](#)