

# HATCH LED DRIVERS

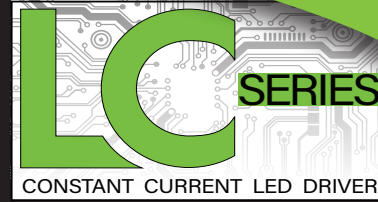

## GENERAL INFORMATION

LED Driver Type	Constant Current
Maximum Wattage	30 Watts
Input Voltage	120 - 277 VAC ± 10% Universal
Input Frequency	50/60Hz
Total Harmonic Distortion	<20%

## CASE STYLE FF: POLYCARBONATE



FOR FUTURE RELEASE

## ELECTRICAL SPECIFICATIONS

Watts	Rated Current	Output Voltage	Dimming Type	Input Voltage	Input Power	Input Current	Power Factor	Efficiency	Hatch Part Number
<b>Dimming Models</b>									
30W	350mA	42 - 85 VDC	0-10V Dimming	120 - 277 VAC	34W	0.36/0.16A	>0.90	89%	LC30-0350Z-UNV-FF
	450mA	34 - 66 VDC	0-10V Dimming	120 - 277 VAC	33W	0.36/0.16A	>0.90	88%	LC30-0450Z-UNV-FF
	700mA	22 - 43 VDC	0-10V Dimming	120 - 277 VAC	33W	0.36/0.16A	>0.90	87%	*LC30-0700Z-UNV-FF

\*Class 2 US

## PRODUCT FEATURES

- Short circuit and overload protection
- Over temperature protection
- Suitable for wet locations
- Withstanding voltage: I/P – O/P 4.0kVDC, 2mA
- Surge rating: 2kV L-N
- Operating temperature range: -40°C to 90°C (measured at Tcase)
- Dimming range: 10%-100%
- Inrush Current: <7A@230VAC, @ 25°C
- MTBF: 324,000 hrs @ 70°C

## APPROVALS

- EN61000-3-2
- EMC: Meets FCC47 CFR Part 15 (Class B) consumer limits
- IP66

TYPE  
HL



## MECHANICAL SPECIFICATIONS: CASE STYLE FF

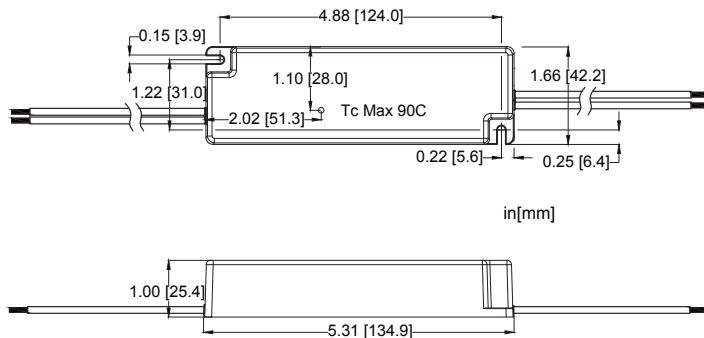

## DIMENSIONS [IN/MM]

Length:	5.31 [134.9]
Mounting:	4.88 [124.0]
Width:	1.66 [42.2]
Height:	1.00 [25.4]

## WIRING INFORMATION

Input:	12", Black (L), White (N) #18AWG
Output:	12", Red (+), Blue (-) #18AWG #22AWG (with Class 2 Output)
Dimming:	12", Purple (+), Grey (-) #22AWG

## PACKAGING INFORMATION

Weight:	8.3oz
Quantity:	40pc/carton

## WARRANTY

- 5 year limited warranty

\* Specifications Subject to Change without notice.

### PERFORMANCE CURVES

#### Efficiency VS Output Power

Efficiency vs. Output Power - 0-10V-Dimming

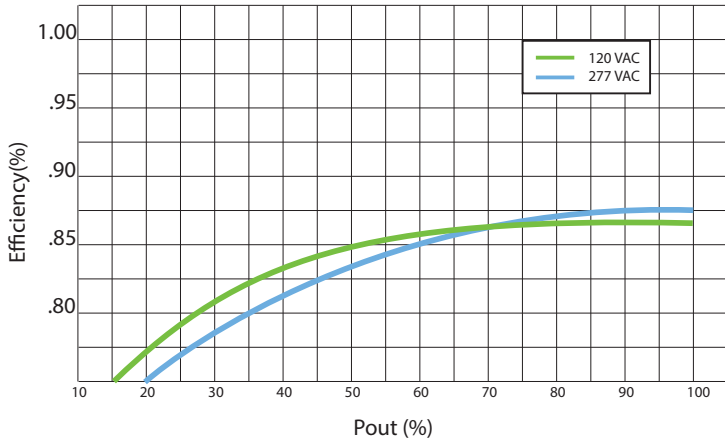

#### Power Factor VS Output Power

Power Factor vs. Output Power - 0-10V Dimming

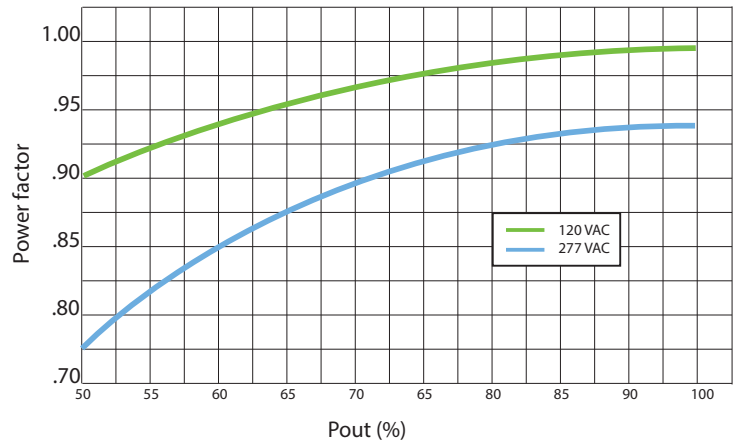

#### THD VS Output Power

THD vs Output Power - 0-10V-Dimming

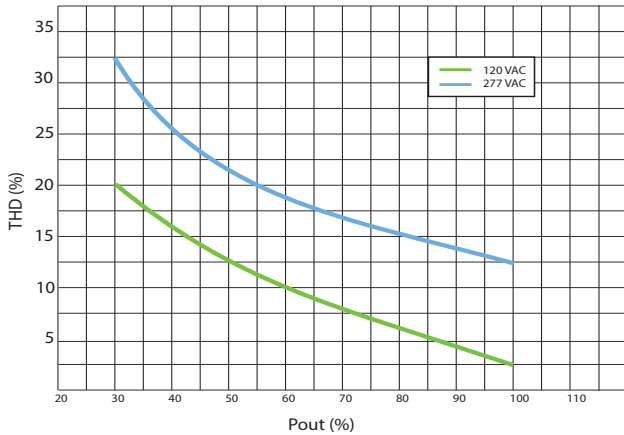

#### Dimming Curves

Dimming Curve - 0-10V Dimming

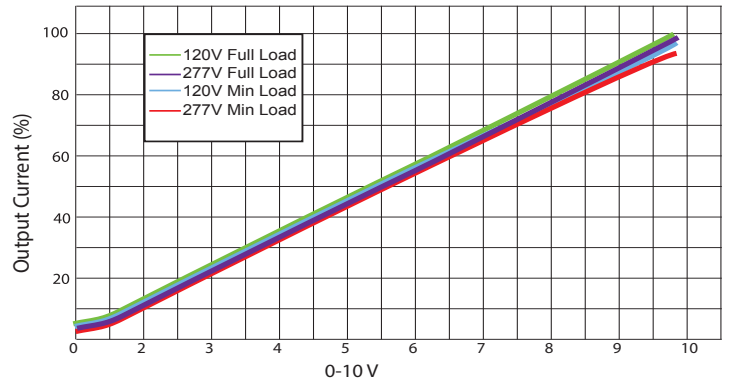

Output voltage range must be maintained throughout entire dimming range.

#### Lifetime VS Case Temperature

Lifetime vs. Case Temperature

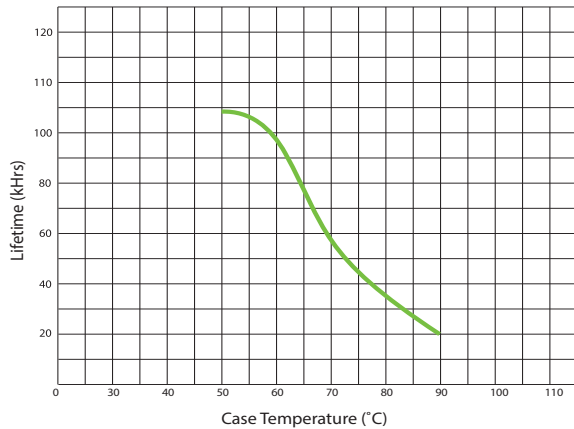

## X-ON Electronics

Largest Supplier of Electrical and Electronic Components

*Click to view similar products for [LED Power Supplies](#) category:*

*Click to view products by [Hatch Lighting](#) manufacturer:*

Other Similar products are found below :

[ESS015W-1000-12](#) [PDA-WIFI](#) [PIFC-K250F](#) [PITB-K222A](#) [ALD-514012PJ134](#) [LB240S24KH](#) [LMH020-SPLC-0000-0000001](#) [LMD600-0100-C1A7-7030000](#) [79534](#) [79535](#) [EUG-200S210DT](#) [ESS030W-1050-21](#) [ESS030W-0900-32](#) [BPOXL 4-12-035](#) [ESS010W-0350-24](#) [ESS010W-0200-42](#) [ESM060W-1400-42](#) [PDA080B-1A0G](#) [PDA150B-S1A5G](#) [SLM140W-1.05-130-ZA](#) [ESS015W-0700-18](#) [EUD-150S350DVA](#) [LWA320-C420-ARK-B](#) [HVG-240-48AB](#) [HVG-320-36AB](#) [HVG-320-54AB](#) [ELG-240-C1400AB](#) [EUK-150S105DV](#) [BXCS-12Z-N2P-B1-A](#) [BXPR-WN-01-A](#) [LN1224CV](#) [BXCS-12D-N2P-01-A](#) [BXCS-12W-N2P-01-A](#) [HBG-160-24AB](#) [980100001200394](#) [980060001200376](#) [LC 14W 250-350MA FLEXC R ADV2](#) [LC 24W 500-600MA FLEXC R ADV2](#) [LC 36W 850-900MA FLEXC R ADV2](#) [LC 50W 200-350ML 170V FLEXC LP SNC4](#) [LC 25W 200-350ML 70V FLEXC LP SNC4](#) [LC 35W 200-350ML 121V FLEXC LP SNC4](#) [LCBI 10W 350MA PHASE-CUT/1-10V LP](#) [LC 13W 300MA FIXC C SNC](#) [LC 10W 250MA FIXC SC SNC2](#) [LC 35W 800MA FIXC SR ADV2](#) [LC 38W 900MA FIXC SR ADV2](#) [LC 34W 800MA FIXC SC ADV2](#) [LC 44W 1050MA FIXC SC ADV2](#) [LC 38W 900MA 42V FIXC SRL ADV2](#)