

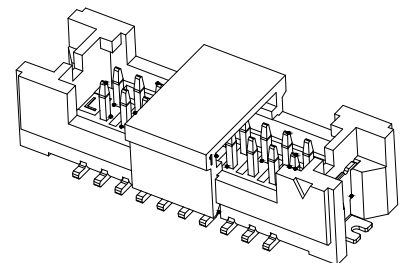

Specifications:
 Poles: 10 to 50
 Contact resistance: ≤30mΩ
 Insulation resistance: ≥500MΩ
 Rated voltage: 150V AC DC
 Rated current: 1.0A AC DC
 Withstand Voltage: 500V AC/minute
 Temperature Range: -25°C ~ +85°C
 Housing: PA9T UL94V-0, Natural (Beige)
 CAP: PA9T UL94V-0, Natural (Beige)
 Contacts: Brass/Sn-plated or Gold-flash
 Solder Tabs: Brass/Sn-plated or Gold-flash



Circuit	Part NO.	Dimensions mm		
		A	B	C
5	HC-1.25-2x5PLT-G	5.00	12.50	6.10
10	HC-1.25-2x10PLT-G	11.25	18.75	12.35
15	HC-1.25-2x15PLT-G	17.50	25.00	18.60
20	HC-1.25-2x20PLT-G	23.75	31.25	24.85
25	HC-1.25-2x25PLT-G	30.00	37.50	31.10

			GENERAL TOLERANCE		制图 DRAWING		 深圳市华灿天禄电子有限公司 ShenzhenhuacantianluELECTRONICS CO.,LTD			
			DIM	TOL	审核 CHECK					
			X.X	±0.30	批准 APPROVAL		产品名称 TITLE	1.25 双排 立贴 (带盖)	版本 REV.	A
1 初版发行			X.XX	±0.20	比例 SCALE		产品料号 PART NO.	HC-1.25-2xNPLT-G	单位 UNITS	mm
序号 No.	变更内容 MODIFY CONTENT	日期 MODIFY DATE	X.XXX	±0.10	投影 Projection		材料 MATERIAL		页次 SHEET	1/2
			Angle	±3.0°						

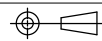
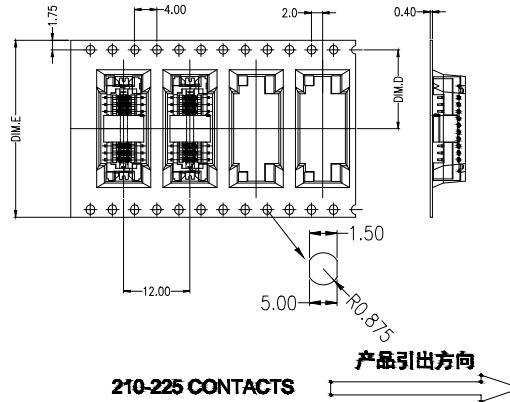
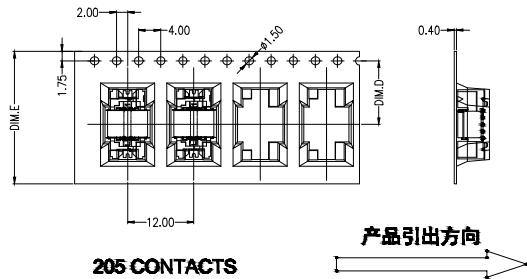

Circuit	D	E	pcs/box	boxes/Carton	Pcs/Box
2x5PLT	11.50	24.00	1000	15	15000
2x10PLT	14.20	32.00	1000	11	11000
2x15PLT	20.20	44.00	1000	8	8000
2x20PLT	20.20	44.00	1000	8	8000
2x25PLT	26.20	56.00	1000	7	7000

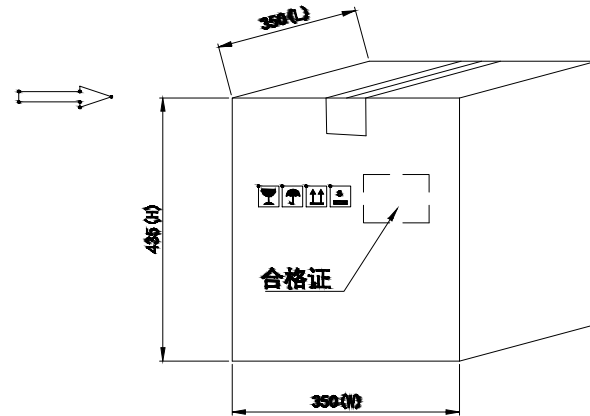
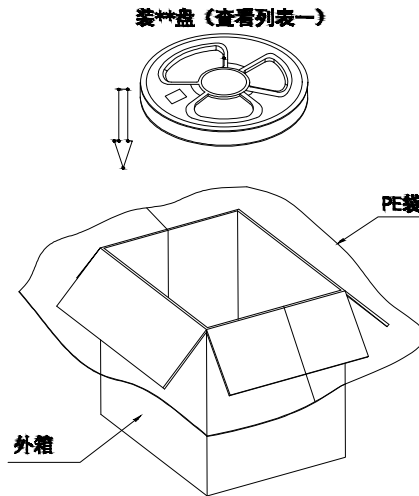
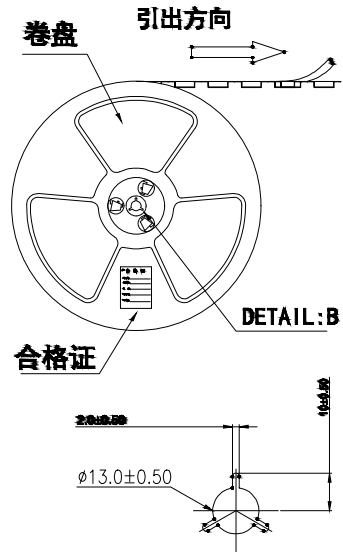
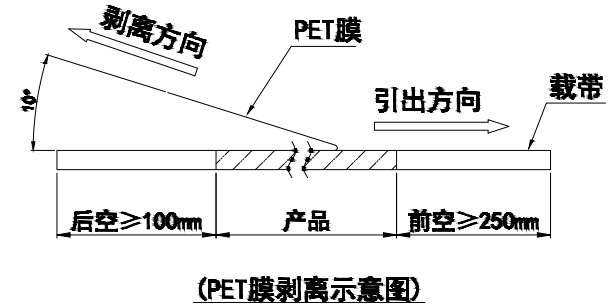

			GENERAL TOLERANCE		制图		深圳市华灿天禄电子有限公司		
			DIM	TOL	DRAWING		ShenzhenhuacantianluELECTRONICS CO.,LTD		
			X.X	±0.30	审核				
			X.XX	±0.20	CHECK				
			X.XXX	±0.10	批准		产品名称		版本
			Angle	±3.0°	APPROVAL		TITLE		REV.
					比例		产品料号		UNIT
					SCALE		PART NO.		SCALE
					投影		材料		UNIT
					Projection		MATERIAL		SHEET
1	初版发行						1.25 双排 立贴(带盖)-包装图		A
序号 No.	变更内容 MODIFY CONTENT	日期 MODIFY DATE					HC-1.25-2xNPLT-G	单位 UNITS	mm
								页次 SHEET	2/2

X-ON Electronics

Largest Supplier of Electrical and Electronic Components

Click to view similar products for [Headers & Wire Housings](#) category:

Click to view products by [HCTL](#) manufacturer:

Other Similar products are found below :

[57102-F02-18ULF](#) [58102-G61-06LF](#) [582553-1](#) [009176003701906](#) [01.001.5753.1](#) [0050291907](#) [02.125.8002.8](#) [609-3404](#) [61062-3](#)
[CSU011177004](#) [622-0430](#) [622-3653LF](#) [63453-116](#) [636-1030](#) [636-1427](#) [636-3427](#) [636-4007](#) [641938-9](#) [65495-038](#) [65692-001LF](#) [65781-018](#)
[65781-047](#) [65817-010LF](#) [65817-015LF](#) [66207-023LF](#) [67095-007LF](#) [67601157](#) [68631-112](#) [68645-018](#) [699319-000](#) [M90C108951C](#)
[70.362.1628.0](#) [70-4210](#) [70-4226B](#) [70-4853B](#) [707-5028](#) [71.350.2428.0](#) [71961-016LF](#) [733-134](#) [733-162](#) [754199-000](#) [760-3052](#) [80.063.4001.1](#)
[800-90-001-10-001000](#) [800-90-010-10-002000](#) [801-43-002-10-013000](#) [801-43-006-10-002000](#) [803-41-018-10-001000](#) [803-43-024-10-](#)
[001000](#) [803-93-012-10-001000](#)