

# 深圳市华灿天禄电子有限公司

## 物料承认书

### SPECIFICATION FOR APPROVAL

客户名称:

Customer: \_\_\_\_\_

产品名称:

Description: \_\_\_\_\_

规格型号:

Modelno: \_\_\_\_\_

PHB系列

物料编号:

Cust P/N: \_\_\_\_\_

出厂签章

校 对 Issuer

审 核 Engineer

批 准 Approver

李攀进

/

罗观彬

承认签章 CUSTOMER

校 对 Issuer

审 核 Engineer

批 准 Approver

地址: 深圳市宝安区40区安乐科技创新园B栋726

TEL:0755-29785550 FAX:0755-29785862

胡先生: 18058866958

Http://www.HCTLDZ.com

E-mail: 18058866958@163.com

确认合格后烦请回签一份给我司存档, 谢谢!

Pls. sign acknowledge and re-turn document to us after confirming, thank you !

# 产 品 承 认 书 目 录

1、封面	1-1
2、目录	2-2
3、技术规范	3-9
4、产品图纸	10-17

## 1、SCOPE

### 适用范围

**The contents of specifications for PHB series connector strip, including product performance, test methods and inspection requirements**

本规格书内容适用于 PHB 系列条形连接器，包含了产品的性能、试验方法和检验要求

## 2、APPLICABLE STANDARDS

### 适用的标准

- |     |          |   |
|-----|----------|---|
| 2.1 | GB/T2421 | <b>Testing method for Environmental of Electrical Connectors Class 1 :<br/>General Principles</b> |
|     | GB/T2421 | 电工电子产品环境试验 第一部分 总则  |
| 2.2 | GB/T2423 | <b>Testing method for Environmental of Electrical Connectors</b>                                  |
|     | GB/T2423 | 电工电子产品环境试验方法  |
| 2.3 | GB/T2424 | <b>Testing method for Environmental of Electrical Connectors</b>                                  |
|     | GB/T2424 | 电工电子产品环境试验导则  |
| 2.4 | GB/T5095 | <b>Testing Procedure/method for components of electric equipment</b>                              |
|     |          | 电子设备用机电元件基本试验规程及测量方法  |

## 3、USE CONDITION

### 使用条件

- 3.1 Ambient temperature Range:-25℃~+85℃**  
环境温度：-25℃~+85℃
- 3.2 Applicable Wire Sizes:AWG#22~#28**  
适用线规：AWG#22~#28
- 3.3 Applicable PC board thickness:1.6mm**  
适用 PC 板厚度：1.6mm

## 4、Appearance and Dimension

### 外观及尺寸

- 4.1 Appearance:Product surface without defect、dirt、crack、and mechanical damang,  
Contact without rust,plating not oxidized and not peeled.**  
产品表面不应有对制品有害的缺陷、污垢、裂痕及机械损伤；接触件无锈蚀、镀层氧化、脱落等现象.
- 4.2 Dimension:According to drawings**  
外形尺寸：依照附图
- 4.3 Exchangable:Exchangable with same specification products.**  
互换性：相同规格应能互换

## 5、Material

### 材 料

P/N 零件名称	Type 类 型	Material 材 料	Finish 表面处理	Expain 说 明
Terminal 端 子	Contact 插 簧	Phosphor bronze 锡青磷铜 厚 0.20mm	Tin Plating:3~5 μ m 镀锡: 3~5 μ m	RoHS
Housing 孔 座	Plastic 塑 壳	Nylon66 UL94V-0	Color: White 颜色: 白色	
Wafer 针 座	Plastic 塑 壳	Nylon66 UL94V-0	Color: Beige 颜色: 米色	
	Contact 插 针	Brass 黄铜 厚□0.50mm	Tin Plating:2.5~5 μ m 镀锡: 2.5~5 μ m	

## 6、Electrical Performance

### 电 气 性 能

N0. 序号	Ltem 项 目	Test mode 试 验 方 法	Requirement 技 术 要 求
6.1	Current Rated 额定电流		3A AC DC
6.2	Voltage Rated 额定电压		250V AC DC
6.3	ContactResistance 接触电阻	A maximum voltage of 20mV and a maximum current of 100mA are applied to the Mate connector 组合状态下的连接器, 两端施以最大测试电压 20 mV 以及最大测试电流 100 mA  Does not include wire resistance 不包含电线阻抗	Initial value Less than 20m Ω  初始值 ≤ 20 m Ω
6.4	withstandvoltage 耐电压	Apply 800V AC(rms)for 1 minute and the leakage current shall not exceed 0.5mA to the adjacent terminal and ground of the Mate connectors  组合状态下的连接器, 相邻两导体末端各施以电压 800V AC(有效值)时间 1 分钟, 且漏电流必须小于 0.5mA(毫安培)	No breakdownor flashover  无击穿或者产生火花
6.5	InsulationResistance 绝缘电阻	Apply 500V DC(rms)for 1 minute between adjacent contacts to measure the insulation resistance  相邻两接触导体, 1 分钟时间内施予 500V DC 电压, 测量期间的绝缘阻抗值	More than 1000 M Ω  ≥ 1000M Ω

## 7、Mechanical Performance:

### 机械性能

NO. 序号	Ltem 项目	Test mode 试验方法		Requirement 技术要求
7.1	Terminal crimping wire strength 端子压接导线强度	Terminal crimping wires, axial per minute to 25 ± 3mm rate of the pullout force  端子所压接电线，以每分钟 25±3mm 速率之轴向拔出力	AWG#22 wire AWG#22 导线	More than 50N ≥50N
			AWG#24 wire AWG#24 导线	More than 30N ≥30N
			AWG#26 wire AWG#26 导线	More than 20N ≥20N
			AWG#28 wire AWG#28 导线	More than 13N ≥13N
7.2	Fixed terminals and hole seat 端子与孔座固定力	The terminal and the hole seat, at a rate per minute to 25 ± 3mm along the wire direction are pulled out from the hole in the seat capacity  端子与孔座配合，以每分钟 25±3mm 的速率沿导 线方向将端子从孔座中拔出的力		Per contact 单一接触点  More than 15N ≥15N
7.3	Singlecontact insertion force 单接触插入力	The Housing together with the terminal ends with Wafer matched, at a rate per minute to 25 ± 3mm, inserting force test  孔座连同端子与针座两端互配,以每分钟 25±3mm 的速率,作插入力测试		Less than 6N  ≤6N
7.4	Single contact withdrawal force 单接触拔出力	The Housing together with the terminal ends with Wafer matched, at a rate per minute to 25 ± 3mm, as the pull-out test  孔座连同端子与针座两端互配,以每分钟 25±3mm 的速率,作拔出力测试		More than 0.5N  ≥0.5N
7.5	Pin Retention force PIN 针固定力	Exerts a force on the pin end, at a rate per minute 25 ± 3mm, until the needle exit seat pull-out force  在针脚前端施加力,以每分钟 25±3mm 的速率, 直到针退出针座的拔出力		Per contact 单一接触点  More than 15N ≥15N
7.6	Durability 耐久性	Mate connectors up 30 cycles at a Maximun rate of 10cycles per minute prior toenvironmental test  组合状态下的连接器且未经环境测试,每分钟内 进行 10 次嵌入与拔出,连续 30 次嵌入与拔出往 返测试		Contact Resistance ≤30 mΩ 接触电阻≤30 mΩ

NO. 序号	Ltem 项目	Test mode 试验方法	Requirement 技术要求
7.7	Vibration 振动	<p>Connector combination state of the welding circuit board as test samples, the request in accordance with the following specifications, resistance to vibration test, whether to produce discontinuous current determined during the experiment (off) phenomenon, after the experiment measuring contact resistance</p> <p>组合状态下的连接器焊接电路板上作为试验样品, 依照如下规格要求, 进行耐振动试验, 试验过程中确定是否产生不连续电流(断电)现象, 试验过后测量接触电阻值</p> <p>Frequency(频率):10-55-10 Hz/minute Amplitude(振幅):1.5mm p-p Direction(方向):            1、 Axis of up and down 上下轴向(Y轴)            2、 Axis of right the left 左右轴向(X轴)            3、 Axis of front and back 前后轴向(Z轴)            Period(周期):2 hous for each direction            每一个轴向持续 2 小时</p>	<p>Appearance: No damage 外观: 无损伤</p> <p>Contact Resistance  <math>\leq 30 \text{ m}\Omega</math>            接触电阻 <math>\leq 30 \text{ m}\Omega</math></p> <p>current Discontinuity:            1 micro second Max            电流中断: <math>1 \mu \text{ sec Max}</math></p>

## 8、Endurance Characteristics:

### 环境性能

NO. 序号	Ltem 项目	Test mode 试验方法	Requirement 技术要求
8.1	Thermal Aging 高温老化试验	<p>Connector combination condition is placed in the oven, the request in accordance with the following specifications, high temperature aging test, after the test and measurement of contact resistance</p> <p>组合状态下的连接器放置于加热烤箱中, 依照如下规格要求, 进行高温老化试验, 试验后并测量接触电阻值</p> <p>Temperature: <math>85 \pm 2 \text{ }^\circ\text{C}</math>            Period: 96 hours continuously            温度: <math>85 \pm 2 \text{ }^\circ\text{C}</math>            周期: 持续 96 小时</p>	<p>Appearance: No damage 外观: 无损伤</p> <p>Contact Resistance  <math>\leq 30 \text{ m}\Omega</math>            接触电阻 <math>\leq 30 \text{ m}\Omega</math></p>

NO. 序号	Ltem 项 目	Test mode 试验方法	Requirement 技术要求
8.2	Temperature 温升	<p>Mate connector measure the temperature rise of contact when the maximum rated current is passed</p> <p>组合状态下的连接器，通过最大容许电流测量导体温度上升值</p>	30°C Max
8.3	Humidity 恒定潮湿	<p>Connector combination under the condition of constant temperature and humidity place space, in accordance with the requirements of the following specifications, constant temperature and humidity test, after the experiment measuring contact resistance, insulation resistance and withstand voltage test</p> <p>组合状态下的连接器放置恒定温度的湿气空间，依照如下规格要求，进行恒温恒湿试验，试验过后测量接触电阻、绝缘电阻以及耐电压测试</p> <p>Temperature: 40 ± 2 °C Relative humidity:90-95%RH Period:96 hours continuously</p> <p>温度:40±2°C 相对湿度:90-95% 周期：持续 96 小时</p>	<p>Appearance: No damage 外观：无损伤</p> <p>Contact Resistance: ≤30m Ω 接触电阻：≤30 m Ω</p> <p>Insulation Resistance: ≥500M Ω 绝缘电阻：≥500M Ω</p> <p>No breakdown or flashover 无击穿或者产生火花</p>
8.4	Temperature cycling 温度循环	<p>The combined state of connectors as test samples, in accordance with the requirements of the following specifications, thermal shock test, after the test measuring contact resistance, insulation resistance, and resistance to voltage</p> <p>组合状态下的连接器作为试验样品，依照如下规格要求，进行冷热冲击试验，试验后测量接触电阻、绝缘电阻、以及耐电压测试</p> <p>One cycle consists of: -55 ± 3°C,30min,Room temp.10-15 min 85 ± 3°C,30min,Room temp.10-15 min Total cycle: 5 cycle</p> <p>-55 ± 3°C,30 分钟，放置转换时间 10-15 分钟 85 ± 3°C,30 分钟，放置转换时间 10-15 分钟 循环次数：5 次</p>	Same as paragraph 8.3 同 8.3 章节

NO. 序号	Ltem 项目	Test mode 试验方法	Requirement 技术要求
8.5	Salt spray 盐雾	<p>The combined state of connector as test samples, salt spray test according to the following specifications, test samples will be clean again with the water to dry naturally, measurement of contact resistance 组合状态下的连接器作为试验样品，依照如下规格要求进行盐水喷雾试验，试验后将样品用清水冲干净自然凉干，测量接触电阻值</p> <p>Temperature: 35±3℃ Solution: 5±1% Period: Stamping after tin plated for 8 hours Stamping before tin plated for 24 hours 温度: 35±3℃ 浓度: 5±1% 周期: 先电镀后冲压 8 小时 先冲压后电镀 24 小时</p>	<p>Appearance: No damage 外观: 无损伤</p> <p>Contact Resistance: ≤30mΩ 接触电阻: ≤30 mΩ</p>
8.6	Solder ability 可焊性	<p>In accordance with the following specifications were placed tin soldering test 放置锡炉中依照如下规格进行焊锡试验</p> <p>Solder Temperature:245±5℃ Immersion period:3±0.5S 焊锡温度: 245±5℃ 沉浸周期: 3±0.5S</p>	<p>Area of Soldering: ≥90% 焊锡面积: ≥90%</p>
8.7	Resistance to soldering heat 耐焊接热	<p>anual soldering tin process Soldering time: 3±0.5S Soldering pot: 350±5℃ 手工烙铁焊锡工艺 焊接时间: 3±0.5S 焊接温度: 350±5℃</p> <p>Mode of operation: 操作方式: Position DIP type needle solder, conductor or a fixed piece at the end of the 1.5mm distance DIP 型针座焊锡位置，距离导体或固定片末端 1.5mm</p> <p>Wave soldering tin soldering process Soldering time: 5±0.5S Soldering pot: 230±5℃ 波峰焊焊锡工艺 焊接时间: 5±0.5S 焊接温度: 230±5℃</p>	<p>Appearance: No damage 外观: 无损伤</p>



## 9、Packaging Transportation Storage

包装、运输、贮存

### 9.1 Packaging

包装

- (1) **Terminal packaging for the dish material packaging, rubber shell packaging for plastic bags, packaging bags or plastic box seat for packaging, loading (paste) into the certificate, indicate the product name, specifications, quantity production date and other information**

端子内包装为盘装带料包装、胶壳内包装为塑料袋，针座包装为袋装或吸塑盒包装，装（贴）入合格证，注明产品名称、规格型号、数量生产日期等信息

- (2) **Exterior package is carton, facing the packing list, the packing list marked with product name, specification model, quantity, date of dispatch.**

外包装为纸箱，贴装箱单、装箱单上注明产品名称、规格型号、数量、出货日期

- (3) **The product in the box must not rock**

产品在箱内不晃动

### 9.2 Transportation

运输

**Any vehicle can be adopted for the transportation, but moisture-proof and no mechanical damage, transport temperature to  $-20^{\circ}\text{C} \sim +50^{\circ}\text{C}$**

允许用任何方式运输，但需避免雨雪直淋和阳光照射，不能有碰撞和挤压等机械损伤，运输环境温度为 $-20^{\circ}\text{C} \sim +50^{\circ}\text{C}$

### 9.3 Storage

贮存

- (1) **The connector of packing finished should be in the ambient temperature between  $-10^{\circ}\text{C}$  to  $+40^{\circ}\text{C}$ , Relative humidity  $\leq 80\%$ . To store in storehouse does not have acidic, alkaline air and other corrosive gas in the ambient air.**

包装完毕的连接器应在环境温度为 $-20^{\circ}\text{C} \sim +40^{\circ}\text{C}$ ，相对湿度 $\leq 80\%$ ，周围空气中没有酸性，碱性及其它腐蚀性气体的库房中贮存

- (2) **Re-qualification test shall be conducted immediately while the storing duration exceed 6 months**

贮存期为6个月，超期6个月需从新检查

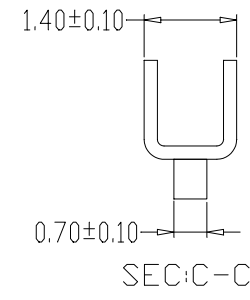
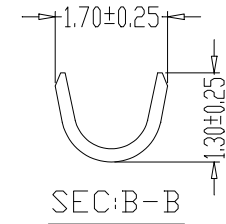
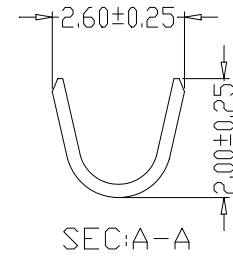
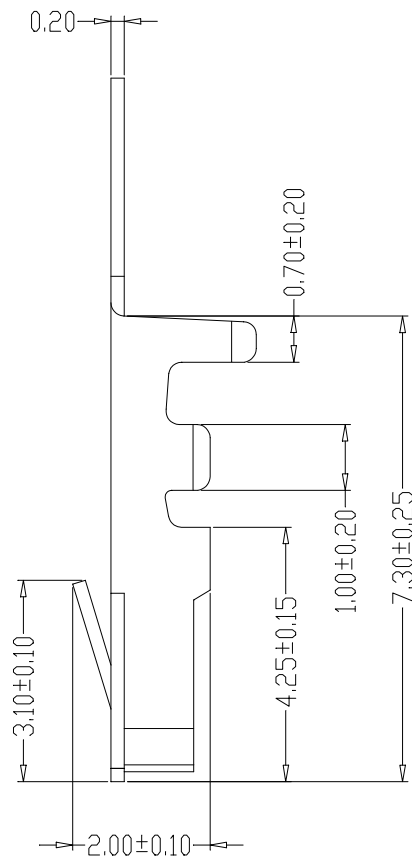
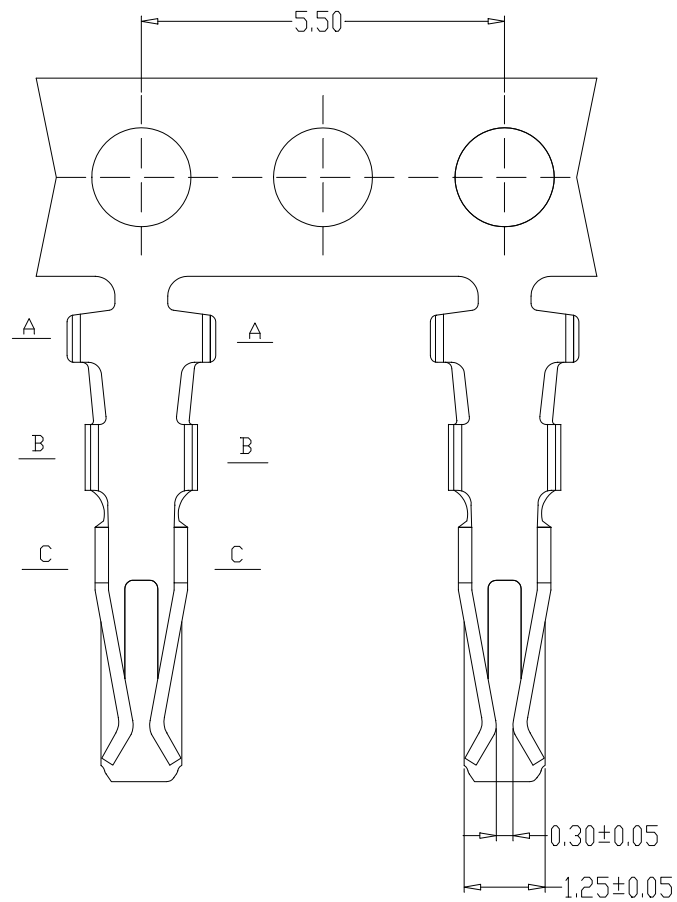

**SPECIFICATIONS**

- 1、Current Rating: 3A AC, DC
- 2、Voltage Rating: 250V AC, DC
- 3、Temperatuer Range: -25°C~+85°C
- 4、Contact Resistance: 20mΩ Max
- 5、Insulation Resistance: 1000MΩ Min
- 6、Withstanding Voltang: 800V AC/minute
- 7、Material:Phosphoric bronze Tin-plated
- 8、Applicable Wire Sizes:AWG#22~28#

制图 DRAWN	变更内容 DESCRIPTION	日期 DATE	GENERAL TOLERANCE		制图 DRAWING	钱岳生 2020、05、20	料号 PART NO.	HC-PHB-T	版本 REV.	A
			X.±0.25	X.°±2°						
			.X±0.20	.X°±1°	审核 CHECK	张名 2020、05、21	品名 TITLE	PHB端子	页次 SHEET	1/1
			.XX±0.15	.XX°±0.5°	核准 APPROVAL	张名 2020、05、22	客户料号 CUTL. NO.			
			.XXX±0.10	.XXX°±0.5°	单位 UNITS	MM	比例 SCALE	1:1		

深圳市华灿天禄电子有限公司

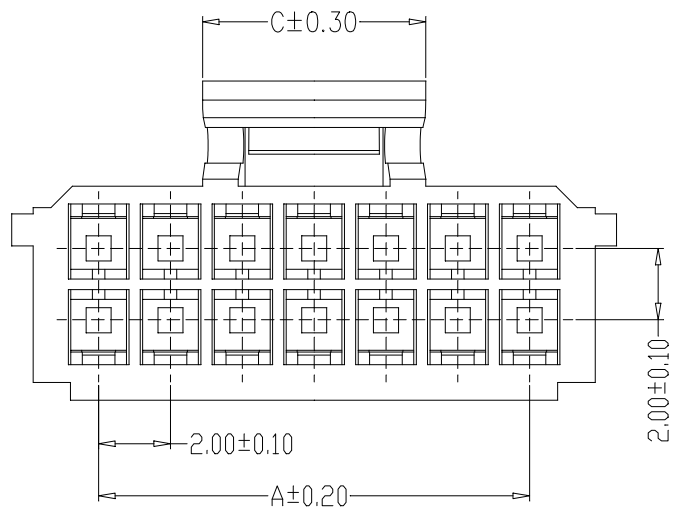
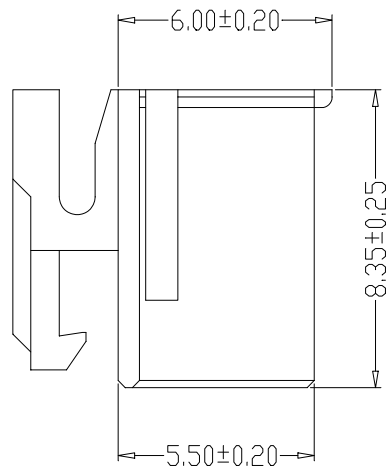
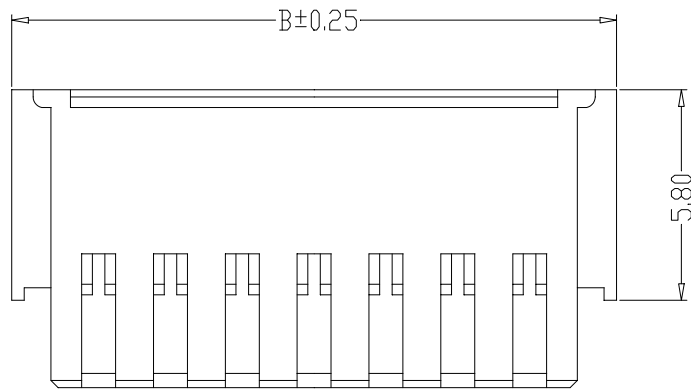

### SPECIFICATIONS

1. Current Rating: 3A AC, DC
2. Voltage Rating: 250V AC, DC
3. Temperature Range:  $-25^{\circ}\text{C} \sim +85^{\circ}\text{C}$
4. Contact Resistance:  $20\text{m}\Omega$  Max
5. Insulation Resistance:  $1000\text{M}\Omega$  Min
6. Withstanding Voltage: 800V AC/minute
7. Material: Nylon66, UL94V-0

编号	尺寸 (mm)		
	A	B	C
HC-PHB-2*2Y	2.00	07.00	3.00
HC-PHB-2*3Y	4.00	09.00	3.00
HC-PHB-2*4Y	6.00	11.00	5.30
HC-PHB-2*5Y	8.00	13.00	6.30
HC-PHB-2*6Y	10.00	15.00	8.30
HC-PHB-2*7Y	12.00	17.00	8.30
HC-PHB-2*8Y	14.00	19.00	12.30
HC-PHB-2*9Y	16.00	21.00	12.30
HC-PHB-2*10Y	18.00	23.00	12.30
HC-PHB-2*11Y	20.00	25.00	16.30
HC-PHB-2*12Y	22.00	27.00	16.30
HC-PHB-2*13Y	24.00	29.00	16.30
HC-PHB-2*14Y	26.00	31.00	16.30
HC-PHB-2*15Y	28.00	33.00	16.30
HC-PHB-2*16Y	30.00	35.00	16.30
HC-PHB-2*17Y	32.00	37.00	16.30
HC-PHB-2*18Y	34.00	39.00	16.30
HC-PHB-2*19Y	36.00	41.00	16.30
HC-PHB-2*20Y	38.00	43.00	16.30

制图 DRAWN	变更内容 DESCRIPTION	日期 DATE	GENERAL TOLERANCE		制图 DRAWING	钱岳生 2013.07.01	料号 PART NO.	HC-PHB-2*NY	版本 REV.	A										
			X.±0.25	X.*±2°							审核 CHECK	张名 2013.07.03	品名 TITLE	PHB孔座	页次 SHEET	1/1				
			.X±0.20	.X*±1°													核准 APPROVAL	张名 2013.07.05	客户料号 CUTL. NO.	
			.XX±0.15	.XX*±0.5°																
.XXX±0.10	.XXX*±0.5°																			
深圳市华灿天禄电子有限公司																				

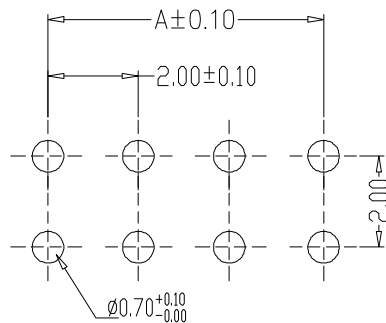
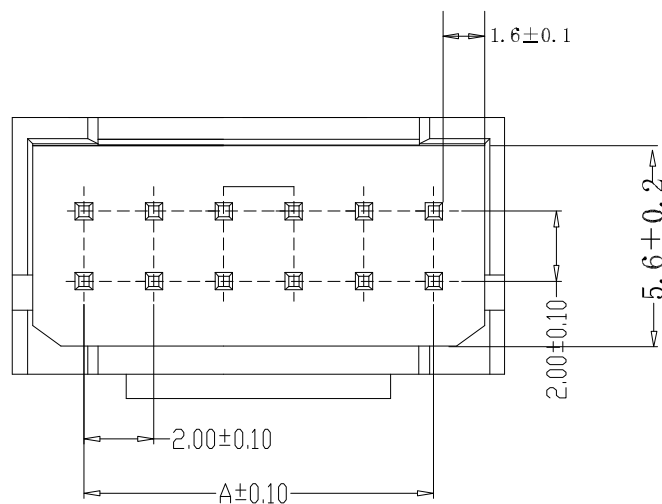
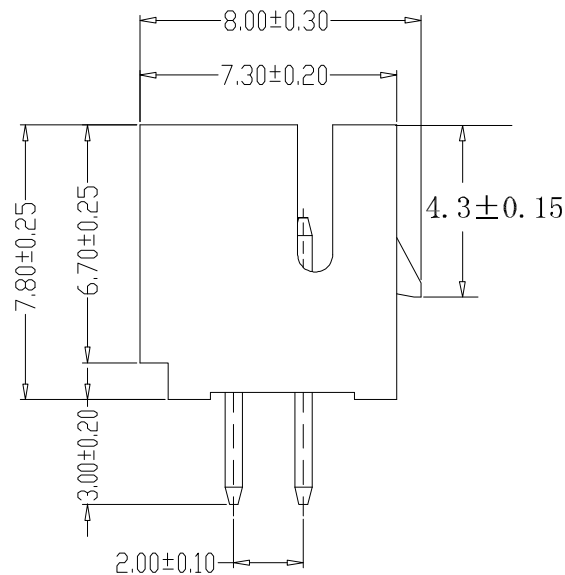
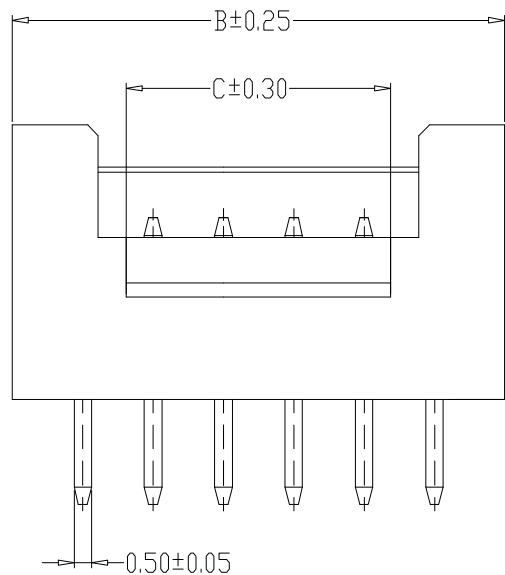

**PCB LAYOUT**

**SPECIFICATIONS**

- 1、Current Rating: 3A AC, DC
- 2、Voltage Rating: 250V AC, DC
- 3、Temperatuer Range:  $-25^{\circ}\text{C} \sim +85^{\circ}\text{C}$
- 4、Contact Resistance:  $20\text{m}\Omega$  Max
- 5、Insulation Resistance:  $1000\text{M}\Omega$  Min
- 6、Withstanding Voltang: 800V AC/minute
- 7、Material: Wafer Nylon66, UL94V-0  
PIN Brass (H65) Tin-plated

编号	尺寸 (mm)		
	A	B	C
HC-PHB-2*2A	2.00	6.00	3.00
HC-PHB-2*3A	4.00	8.00	3.00
HC-PHB-2*4A	6.00	10.00	3.00
HC-PHB-2*5A	8.00	12.00	5.00
HC-PHB-2*6A	10.00	14.00	7.00
HC-PHB-2*7A	12.00	16.00	9.00
HC-PHB-2*8A	14.00	18.00	11.00
HC-PHB-2*9A	16.00	20.00	13.00
HC-PHB-2*10A	18.00	22.00	15.00
HC-PHB-2*11A	20.00	24.00	17.00
HC-PHB-2*12A	22.00	26.00	19.00
HC-PHB-2*13A	24.00	28.00	21.00
HC-PHB-2*14A	26.00	30.00	23.00
HC-PHB-2*15A	28.00	32.00	25.00
HC-PHB-2*16A	30.00	34.00	27.00
HC-PHB-2*17A	32.00	36.00	29.00
HC-PHB-2*18A	34.00	38.00	31.00
HC-PHB-2*19A	36.00	40.00	33.00
HC-PHB-2*20A	38.00	42.00	35.00

制图 DRAWN	变更内容 DESCRIPTION	日期 DATE	GENERAL TOLERANCE		制图 DRAWING 2013、07、01	料号 PART NO. HC-PHB-2*NA	版本 REV. A					
			X.±0.25	X.*±2'				审核 CHECK 2013、07、03	品名 TITLE PHB直针 WAFER DIP TYPE	页次 SHEET 1/1		
			.X±0.20	.X*±1'							核准 张名	客户料号 CUTL. NO.
			XX+0.15	XX*±0.5'								

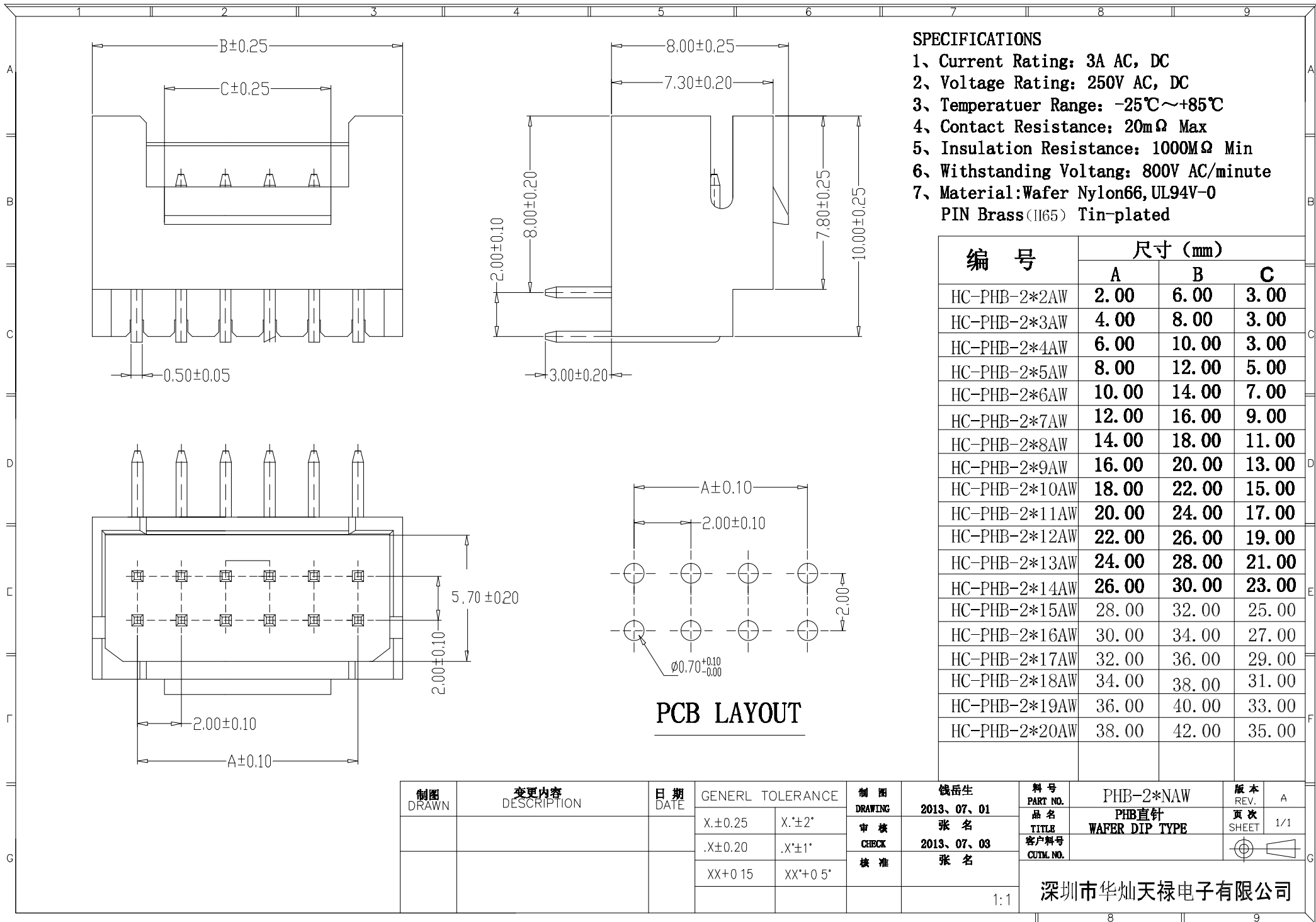

**SPECIFICATIONS**

- 1、Current Rating: 3A AC, DC
- 2、Voltage Rating: 250V AC, DC
- 3、Temperatuer Range: -25℃~+85℃
- 4、Contact Resistance: 20mΩ Max
- 5、Insulation Resistance: 1000MΩ Min
- 6、Withstanding Voltang: 800V AC/minute
- 7、Material: Wafer Nylon66, UL94V-0  
PIN Brass (H65) Tin-plated

编 号	尺寸 (mm)		
	A	B	C
HC-PHB-2*2AW	2.00	6.00	3.00
HC-PHB-2*3AW	4.00	8.00	3.00
HC-PHB-2*4AW	6.00	10.00	3.00
HC-PHB-2*5AW	8.00	12.00	5.00
HC-PHB-2*6AW	10.00	14.00	7.00
HC-PHB-2*7AW	12.00	16.00	9.00
HC-PHB-2*8AW	14.00	18.00	11.00
HC-PHB-2*9AW	16.00	20.00	13.00
HC-PHB-2*10AW	18.00	22.00	15.00
HC-PHB-2*11AW	20.00	24.00	17.00
HC-PHB-2*12AW	22.00	26.00	19.00
HC-PHB-2*13AW	24.00	28.00	21.00
HC-PHB-2*14AW	26.00	30.00	23.00
HC-PHB-2*15AW	28.00	32.00	25.00
HC-PHB-2*16AW	30.00	34.00	27.00
HC-PHB-2*17AW	32.00	36.00	29.00
HC-PHB-2*18AW	34.00	38.00	31.00
HC-PHB-2*19AW	36.00	40.00	33.00
HC-PHB-2*20AW	38.00	42.00	35.00

**PCB LAYOUT**

制图 DRAWN	变更内容 DESCRIPTION	日期 DATE	GENERAL TOLERANCE		制图 DRAWING	钱岳生 2013、07、01	料号 PART NO.	PHB-2*NAW	版本 REV.	A										
			X.±0.25	X.'±2'							审核 CHECK	张名 2013、07、03	品名 TITLE	PHB直针 WAFER DIP TYPE	页次 SHEET	1/1				
			.X±0.20	.X'±1'													核准	张名	客户料号 CUTM. NO.	
			XX+0.15	XX'+0.5'																

### SPECIFICATIONS

- 1、Current Rating: 3A AC, DC
- 2、Voltage Rating: 250V AC, DC
- 3、Temperatuer Range: -25°C~+85°C
- 4、Contact Resistance: 20mΩ Max
- 5、Insulation Resistance: 1000MΩ Min
- 6、Withstanding Voltang: 800V AC/minute
- 7、Material: Wafer LCP, UL94V-0  
PIN Brass Tin-plated

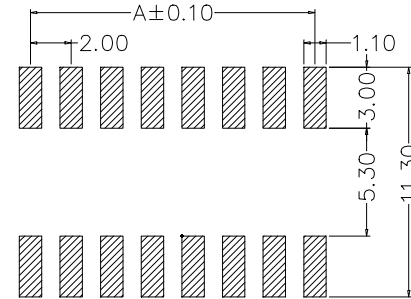
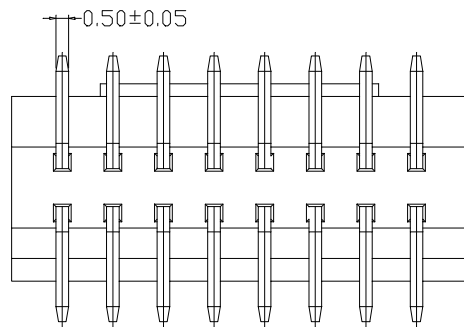
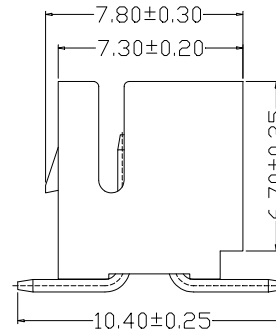
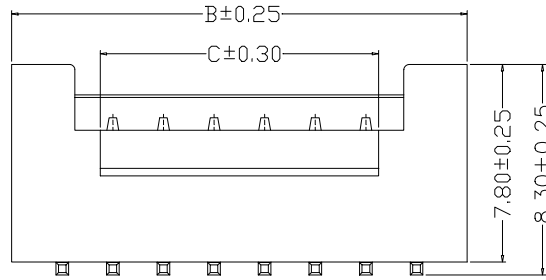
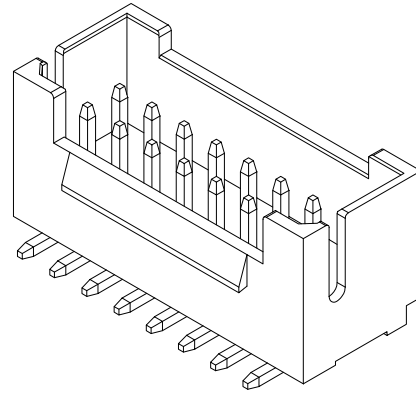
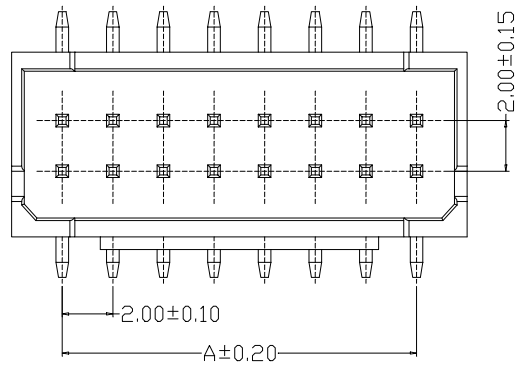

PCB LAYOUT

编号	尺寸 (mm)		
	A	B	C
HC-PHB-2*2AW	2.00	6.00	3.00
HC-PHB-2*3AW	4.00	8.00	3.00
HC-PHB-2*4AW	6.00	10.00	3.00
HC-PHB-2*5AW	8.00	12.00	5.00
HC-PHB-2*6AW	10.00	14.00	7.00
HC-PHB-2*7AW	12.00	16.00	9.00
HC-PHB-2*8AW	14.00	18.00	11.00
HC-PHB-2*9AW	16.00	20.00	13.00
HC-PHB-2*10AW	18.00	22.00	15.00
HC-PHB-2*11AW	20.00	24.00	17.00
HC-PHB-2*12AW	22.00	26.00	19.00
HC-PHB-2*13AW	24.00	28.00	21.00
HC-PHB-2*14AW	26.00	30.00	23.00
HC-PHB-2*15AW	28.00	32.00	25.00
HC-PHB-2*16AW	30.00	34.00	27.00
HC-PHB-2*17AW	32.00	36.00	29.00
HC-PHB-2*18AW	34.00	38.00	31.00
HC-PHB-2*19AW	36.00	40.00	33.00
HC-PHB-2*20AW	38.00	42.00	35.00

制图 DRAWN	变更内容 DESCRIPTION	日期 DATE	GENERAL TOLERANCE		制图 DRAWING	钱岳生 2016、10、24	料号 PART NO.	HC-PHB-2*NALT	版本 REV.	A
			X.±0.25	X.°±2°	审核 CHECK	张名 2016、10、24	品名 TITLE	PHB立贴 WAFER SMT TYPE	页次 SHEET	1/1
			.X±0.20	.X°±1°	核准 APPROVAL	张名 2016、10、25	客户料号 CUSTM. NO.			
			.XX±0.15	.XX°±0.5°	单位 UNITS	MM	比例 SCALE	1:1	深圳市华灿天禄电子有限公司	
			.XXX±0.10	.XXX°±0.5°						

## X-ON Electronics

Largest Supplier of Electrical and Electronic Components

*Click to view similar products for [Headers & Wire Housings](#) category:*

*Click to view products by [HCTL](#) manufacturer:*

Other Similar products are found below :

[57102-F02-18ULF](#) [58102-G61-06LF](#) [582553-1](#) [0009485154](#) [009176003701906](#) [0050291907](#) [00-9021-0611-00-339](#) [02.125.8002.8](#) [609-3404](#)  
[61062-3](#) [622-0430](#) [622-3653LF](#) [63453-116](#) [636-1030](#) [636-1427](#) [636-3427](#) [636-4007](#) [641938-9](#) [65495-038](#) [65692-001LF](#) [65781-018](#) [65781-](#)  
[047](#) [65817-015LF](#) [66207-023LF](#) [67016-026LF](#) [67095-007LF](#) [68631-112](#) [68645-018](#) [68648-049](#) [699319-000](#) [M90C108951C](#) [70.362.1628.0](#)  
[70-4210](#) [70-4226B](#) [70-4853B](#) [707-5020](#) [707-5028](#) [71.350.2428.0](#) [71961-016LF](#) [733-134](#) [754199-000](#) [760-3052](#) [787-8014-00](#) [FCN-367T-](#)  
[T012/H](#) [80.063.4001.1](#) [800-90-001-10-001000](#) [801-43-002-10-013000](#) [801-43-006-10-002000](#) [803-41-018-10-001000](#) [803-43-014-20-001000](#)