



深圳市华灿天禄电子有限公司

物料承认书

SPECIFICATION FOR APPROVAL

客户名称: _____
 Customer: _____
 产品名称: _____
 Description: PHB 2.0 系列
 规格型号: _____
 Modelno: _____
 物料编号: _____
 Cust P/N: _____

出厂签章

校对 Issuer

审核 Engineer

批准 Approver

李攀进	/	罗观彬
-----	---	-----

承认签章 CUSTOMER

校对 Issuer

审核 Engineer

批准 Approver

--	--	--

地址: 深圳市宝安区40区安乐科技创新园B栋726
 TEL:0755-27204342 FAX:0755-29785862
 Http://www.HCTLDZ.com
 E-mail: jinpan.hu@hctldz.com

确认合格后烦请回签一份给我司存档, 谢谢!

Pls. sign acknowledge and re-turn document to us after confirming, thank you !

产 品 承 认 书 目 录

1、封面	1-1
2、目录	2-2
3、技术规范	3-12
4、产品图纸	13-**



TITLE: 2.00MM PITCH PHB CONNECTOR DOUBLE ROW TYPE

PART No. : HC-PHB - ****

RELEASE DATE: 2019/7/25

REVISION: A

ECN No. :

PAGE: 3 OF 12

1、Scope

适用范围

The contents of specifications for PHB series connector strip including product performance, test methods and inspection requirements

本规格书内容适用于 PHB 系列条形连接器，包含了产品的性能，试验方法和试验要求

2、APPLICABLE STANDARDS

适用的标准

- 2.1 GB/T2421 Testing method for Environmental of Electrical Connectors Class 1:
General Principles
GB/T2421 电工电子产品环境试验 第一部分 总则
- 2.2 GB/T2423 Testing method for Environmental of Electrical Connectors
GB/T2423 电工电子产品环境试验方法
- 2.3 GB/T2424 Testing method for Environmental of Electrical Connectors
GB/T2424 电工电子产品环境试验导则
- 2.4 GB/T5095 Testing procedure/method for components of electric equipment
GB/T5095 电子设备机电元件基本试验规则及测量方法

3、USE CONDITION

使用条件

- 3.1 Ambient temperature Range: $-25^{\circ}\text{C} \sim +85^{\circ}\text{C}$
环境温度: $-25^{\circ}\text{C} \sim +85^{\circ}\text{C}$
- 3.2 Applicable Wire Sizes: AWG #22~#28
适用线规: AWG #22~#28
- 3.3 Applicable PC board thickness: 1.6mm
适用PC板厚度: 1.6mm

4、Appearance and Dimension

外观尺寸

- 4.1 Appearance : Product surface without defect 、dirt、crack、and mechanical damage, Contact without rust plating not oxides and not peeled
产品表面不应有对制品有害的缺陷、污垢、裂痕及机械损伤；接触件无锈蚀、镀层氧化、脱落等现象。
- 4.2 Dimension: According to drawings
外观尺寸: 依照附图
- 4.3 Exchangeable: Exchangeable with same specification products.
互换性: 相同规格应能互换



深圳市华灿天禄电子有限公司

TITLE: 2.00MM PITCH PHB CONNECTOR DOUBLE ROW TYPE

PART No. : HC-PHB - ****

RELEASE DATE: 2019/7/25

REVISION: A

ECN No. :

PAGE: 4 OF 14

5、Material

材料

No. 序号	P/N 零件名称	Type 类型	Material 材料	Finish 表面处理	Explain 说明
5.1	Terminal 端子-PT	Contact 插簧	Phosphor bronze 锡青磷铜厚0.2mm	Tin plating:3~5μ m 镀锡: 3~5μ m	ROHS
5.2	Housing 孔座-P	Plastic 塑壳	Nylon66 UL94V-0	Color: White 颜色: 白色	
5.3	Wafer 针座	Plastic 塑壳	Nylon66 UL94V-0	Color: Beige 颜色: 米色	
		Contact 插针	Brass 黄铜 厚 0.50mm	Tin plating:2.5~5μ m 镀锡: 2.5~5μ m	



TITLE: 2.00MM PITCH PHB CONNECTOR DOUBLE ROW TYPE

PART No. : HC-PHB - ****

RELEASE DATE: 2019/7/25

REVISION: A

ECN No. :

PAGE: 5 OF 12

6、Electrical Performance

电气性能

No. 序号	Item 项目	Test mode 试验方法	Requirement 技术要求
6.1	Current Rated 额定电流		3A AC DC
6.2	Voltage Rated 额定电压		250V AC DC
6.3	Contact Resistance 接触电阻	<p>A maximum voltage of 20mV and maximum current of 100mA are applied to the Mate connector</p> <p>组合状态下的连接器，两端施以最大测试电压20 mV以及最大测试电流100 mA</p> <p>Does not include wire resistance</p> <p>不包含电线阻抗</p>	<p>Initial value less than 20mΩ</p> <p>初始值 ≤ 20Ω</p>
6.4	Withstand voltage 耐电压	<p>Apply 800V AC(rms) for 1 minute and the leakage current shall not exceed 0.5mA to the adjacent terminal and ground of the mate connectors</p> <p>组合状态下的连接器，相邻两导体末端各施以电压800V AC（有效值）时间1分钟，且漏电流必须小于0.5mA（毫安培）</p>	<p>No breakdown or flashover</p> <p>无击穿或者产生火花</p>
6.5	Insulation Resistance 绝缘电阻	<p>Apply 500V DC(rms) for 1 minute between adjacent contacts to measure the insulation resistance</p> <p>相邻两接触导体，一分钟内施以 500V DC电压，测量期间的绝缘阻抗值</p>	<p>More than 1000 MΩ</p> <p>≥1000MΩ</p>



TITLE: 2.00MM PITCH PHB CONNECTOR DOUBLE ROW TYPE

PART No.: HC-PHB - ****

RELEASE DATE: 2019/7/25

REVISION: A

ECN No.:

PAGE: 6 OF 12

7、 Mechanical Performance:

机械性能

No. 序号	Item 项目	Test mode 试验方法	Requirement 技术要求
7.1	Terminal crimping Wire strength 端子压接导线强度	Terminal crimping wire Axial per minute to 25 ±3mm rate of the pullout force 端子所压接电线，以每分钟 25±3mm 速之轴向拔出力	AWG#22wire AWG#22导线 More than 50N ≥50N
			AWG#24wire AWG#24导线 More than 30N ≥30N
			AWG#26wire AWG#26导线 More than 20N ≥20N
			AWG#28wire AWG#28导线 More than 13N ≥13N
7.2	Fixed terminals And hole seat 端子与孔座固定力	The terminal and the hole seat at a react per minute to 25 ±3mm along the write direction are pulled out from the hole in the seat capacity 端子与孔座配合以每分钟 25±3mm 的速度 沿导线方向, 将端子从孔座中拔出的力	Percontact 单一接触点 More than 15N ≥15N
7.3	Single contact insertion force 单接触插入力	The housing together with the terminal ends with wafer matched at a rate per minute to 25±3mm inserting force test 孔座连同端子与针座两端互配以每分钟 25 ±3mm 的速度作插入力测试	Less than 6N≤6N
7.4	Single contact Withdrawal force 单接触拔出力	The housing together with the terminal ends with wafer matched at a rate per minute to 25±3mm inserting force test 孔座连同端子与针座两端互配以每分钟 25 ±3mm 的速度作拔出力测试	More than 0.5N ≥0.5N
7.5	Pin Retention Force pin Pin针固定力	Exerts a force on the pin end at a rate per Minute 25±3mm until the needle exit Seat pull-out force 在脚端施加力以每分钟 25±3mm 的速度直到 针退出针座的拔出力	Percontact 单一接触点 More than 15N ≥15N



TITLE: 2.00MM PITCH PHB CONNECTOR DOUBLE ROW TYPE

PART No.: HC-PHB - ****

RELEASE DATE: 2019/7/25

REVISION: A

ECN No.:

PAGE: 7 OF 12

7、 Mechanical Performance:

机械性能

No. 序号	Item 项目	Test mode 试验方法	Requirement 技术要求
7.6	Durability 耐久性	<p>Mate connectors up 30 cycles at a Maximum rate of 10 cycles per minute prior to environmental test</p> <p>组合状态下的连接器且未经环境测试每分钟内进行10次嵌入与拔出，连续30次嵌入与拔出往返测试</p>	<p>Contact Resistance $\leq 30m \Omega$</p> <p>接触电阻 $\leq 30m \Omega$</p>
7.7	Vibration 振动	<p>Mate connector combination state of the welding circuit board as test samples the request in accordance with the following specification resistance to vibration test whether to produce discontinuous current determined during the experiment (off) phenomenon after the experiment measuring contact resistance</p> <p>组合状态下的连接器焊接电路板上作为实验样品，依照如下规格要求，进行耐震动实验，实验过程中确定是否产生不连续电流（断电）现象，实验过后测量接触电阻值</p> <p>Frequency (频率): 10-55-10Hz/minute Amplitude (振幅): 1.5mm p-p Direction (方向): 1、 Axis of up and down 上下轴向 (Y轴) 2、 Axis of right the left 左右轴向 (X轴) 3、 Axis of front and back 前后轴向 (Z轴)</p> <p>Period (周期): 2hour for each direction 每一个轴向持续2小时</p>	<p>Appearance: No damage 外观: 无损伤</p> <p>Contact Resistance $\leq 30m \Omega$ 接触电阻 $\leq 30m \Omega$</p> <p>Current Discontinuity I micro second Max 电流中断: 1 μ sec Max</p>



TITLE: 2.00MM PITCH PHB CONNECTOR DOUBLE ROW TYPE

PART No.: HC-PHB - ****

RELEASE DATE: 2019/7/25

REVISION: A

ECN No.:

PAGE: 8 OF 12

8、 Endurance Characteristics:

环境性能

No. 序号	Item 项目	Test mode 试验方法	Requirement 技术要求
8.1	Thermal Aging 高温老化实验	<p>Connector combination condition is placed in the accordance with the following specifications high temperature aging test after the test and measurement of contact resistance</p> <p>组合状态下的连接器放置与加热烤箱中，依照如下规格要求，进行高温老化实验，试验后并测量接触电阻值</p> <p>Temperature: 85± 2℃ Period: 96 hours continuously 温度: 85±2℃ 周期: 持续96小时</p>	<p>Appearance: No damage 外观: 无损伤</p> <p>Contact Resistance ≤30m Ω 接触电阻 ≤30m Ω</p>
8.2	Temperature 温升	<p>Mate connector measure the temperature rise of contact when the maximum rated current is passed</p> <p>组舍状态下的连接器，通过最大容许电流测量导体温度上升值</p>	30℃ Max



TITLE: 2.00MM PITCH PHB CONNECTOR DOUBLE ROW TYPE

PART No.: HC-PHB - ****

RELEASE DATE: 2019/7/25

REVISION: A

ECN No.:

PAGE: 9 OF 12

8、 Endurance Characteristics:

环境性能

No. 序号	Item 项目	Test mode 试验方法	Requirement 技术要求
8.3	Humidity 恒定潮湿	<p>Connector combination under the condition of constant temperature of the following specifications constant temperature and humidity test after the experiment measuring contact resistance insulation resistance and withstand voltage test</p> <p>组合状态下的连接器放置恒定温度的湿气空间，依照如下规格要求，进行恒温恒湿实验，实验过后测量接触电阻、绝缘电阻以及耐电压测试</p> <p>Temperature: 40±2 °C (温度: 40±2 °C)</p> <p>Relative humidity: 90-95% (RH 相对湿度: 90-95%)</p> <p>Period: 96 hours continuously (周期: 持续96小时)</p>	<p>Appearance: No damage 外观: 无损伤</p> <p>Contact Resistance ≤30m Ω 接触电阻 ≤30m Ω</p> <p>Insulation Resistance ≥500m Ω</p> <p>No breakdown or flashover 无击穿或者产生火</p>
8.4	Temperature cycling 温度循环	<p>The combined state of connectors as test samples in accordance with the requirements of the following specifications thermal shock test after the test measuring contact resistance insulation resistance and resistance to voltage</p> <p>组合状态下的连接器作为实验样品，依照如下规格要求进行冷热冲击实验，试验后测量接触电阻、绝缘电阻、以及耐电压测试</p> <p>One cycle consists of -55±3 °C 30min, room temp 10-15min 85±3 °C 30min, room temp 10-15min Total cycle :5cycle -55±3°C 30分钟，放置转换时间10-15分钟 85±3°C 30分钟，放置转换时间10-15分钟 钟循环次数: 5次</p>	<p>Same as paragraph 8.3 同8.3章节</p>



TITLE: 2.00MM PITCH PHB CONNECTOR DOUBLE ROW TYPE

PART No.: HC-PHB - ****

RELEASE DATE: 2019/7/25

REVISION: A

ECN No.:

PAGE: 10 OF 12

8、 Endurance Characteristics:

环境性能

No. 序号	Item 项目	Test mode 试验方法	Requirement 技术要求
8.5	Salt spray 盐雾	<p>The combined state of connector as test samples salt spray test according to the following specifications test samples will be clean again with the water to dry naturally measurement of contact resistance</p> <p>组合状态下的连接器作为实验样品，依照如下规格要求进行盐水喷雾实验，实验后将样品用清水冲干净自然晾干测量接触电阻值</p> <p>Temperature :35 ±3 °C Solution:5± 1 % Period: Stamping after tin plated for 8 hours Stamping before tin plated for 24 hours</p> <p>温度： 35±3 °C 浓度： 5±1% 周期： 先电镀后冲压8小时 先冲压后电镀24小时（接触区）</p>	<p>Appearance: No damage 外观：无损伤</p> <p>Contact Resistance ≤30m Ω 接触电阻 ≤30m Ω</p>
8.6	Solder ability 可焊性	<p>In accordance with the following specifications were placed tin soldering test</p> <p>放置锡炉中依照如下规格进行焊锡实验</p> <p>Solder temperature : 245± 5° C Immersion period:: 3 ± 0.5S 焊锡温度： 245±5° C 沉浸周期： 3±0.5S</p>	<p>Area of soldering: ≥90 % 焊锡面积： ≥90 %</p>



TITLE: 2.00MM PITCH PHB CONNECTOR DOUBLE ROW TYPE

PART No.: HC-PHB - ****

RELEASE DATE: 2019/7/25

REVISION: A

ECN No.:

PAGE: 11 OF 12

8、 Endurance Characteristics:

环境性能

No. 序号	Item 项目	Test mode 试验方法	Requirement 技术要求
8.7	Resistance to soldering heat 耐焊接热	<p>Annual soldering tin process Soldering time: 3 ± 0.5S Soldering pot : 350 ± 5° C 手工烙铁焊锡工艺 焊接时间: 3 ± 0.5S 焊接温度: 350 ± 5 °C</p> <p>Mode of operation: 操作方式:</p> <p>Position DIP type needle solder conducto or a fixed piece at the end of the 1.5mm distance DIP型针座焊锡位置, 距离导体或固定片末端1.5mm</p> <p>Wave soldering tin soldering process Soldering time : 5 ± 0.5S Soldering pot: 230 ± 5 ° C 波峰焊焊锡工艺 焊接时间: 5 ± 0.5S 焊接温度: 230 ± 5 °C</p>	<p>Appearance: No damage 外观: 无损伤</p>



TITLE: 2.00MM PITCH PHB CONNECTOR DOUBLE ROW TYPE

PART No.: HC-PHB - ****

RELEASE DATE: 2019/7/25

REVISION: A

ECN No.:

PAGE: 12 OF 12

9、Packaging Transportation Storage

包装、运输、储存

9.1 Packaging

包装

(1) Terminal within the Packaging for disc loading material Packaging plastic shell packaging for plastic has seat plates tubes mounted (paste) into the certificate indicate the product name specifications quantity production date and other information

端子内包装为盘装带料包装、胶壳内包装为塑料带，针座包装为盘装，袋装，(贴) 装入合格证，注明产品名称、规格型号、数量、出货日期等信息。

(2) Exterior package is carton facing the packing list the packing list marked with product name specification model quantity date of dispatch

外包装为纸箱，贴装箱单，装箱单上注明产品名称、规格型号、数量、出货日期

(3) The product in the box must not rock

产品在箱内不晃动

9.2 Transportation

运输

Any vehicle can be adopted for the transportation but moisture-proof and no mechanical damage Transport temperature to $-20\text{ }^{\circ}\text{C} \sim +50\text{ }^{\circ}\text{C}$

允许用任何方式运输，但须避免雨雪直淋和阳光照射。不能有碰撞和挤压等机械损伤，运输环境温度为 $-20\text{ }^{\circ}\text{C} \sim +50\text{ }^{\circ}\text{C}$

9.3 Storage

贮存

(1) The connector of packing finished should be in the ambient temperature between $-20\text{ }^{\circ}\text{C} \sim +40\text{ }^{\circ}\text{C}$ relative humidity $\leq 80\%$ to store in storehouse air and other corrosive gas in the ambient air

包装完毕的连接器应在环境温度为 $-20\text{ }^{\circ}\text{C} \sim +40\text{ }^{\circ}\text{C}$ ，相对湿度 $\leq 80\%$ ，周围空气中没有酸性，碱性及其它腐蚀性气体的库房中贮存

(2) Re-qualification test shall be conducted immediately while the storing duration exceed 6 mouths

贮存期为6个月，超期6个月需从新检查

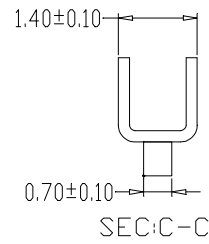
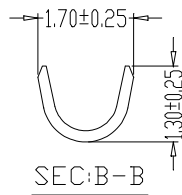
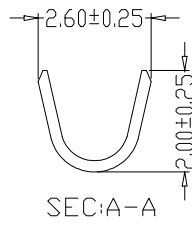
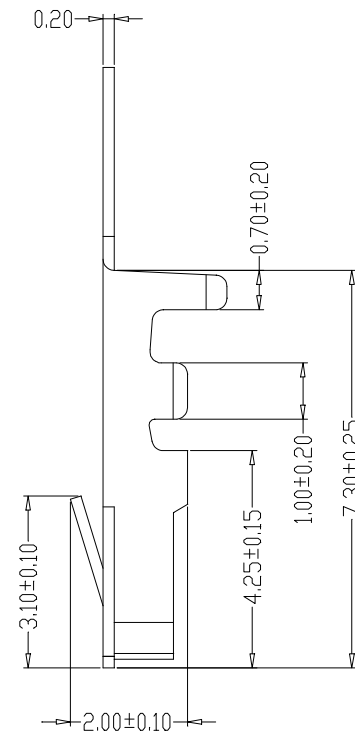
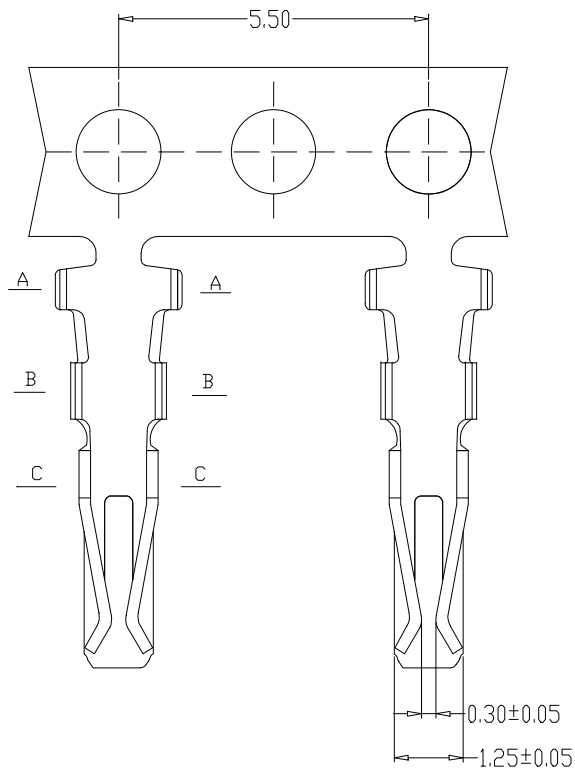

SPECIFICATIONS

- 1、Current Rating: 3A AC, DC
- 2、Voltage Rating: 250V AC, DC
- 3、Temperatuer Range: -25℃~+85℃
- 4、Contact Resistance: 20mΩ Max
- 5、Insulation Resistance: 1000MΩ Min
- 6、Withstanding Voltang: 800V AC/minute
- 7、Material:Phosphoric bronze Tin-plated
- 8、Applicable Wire Sizes:AWG#22~28#

			GENERAL TOLERANCE		制图 DRAWING	 深圳市华灿天禄电子有限公司 ShenzhenhuacantianluELECTRONICS CO.,LTD			
			DIM	TOL	审核 CHECK				
			X.X	±0.30	批准 APPROVAL	产品名称 TITLE	端子	版本 REV.	A
			X.XX	±0.20	比例 SCALE	产品料号 PART NO.	HC-PHB-T	单位 UNITS	mm
			X.XXX	±0.10		投影 Projection	材料 MATERIAL	页次 SHEET	1/1
1	初版发行								
序号 No.	变更内容 MODIFY CONTENT	日期 MODIFY DATE							

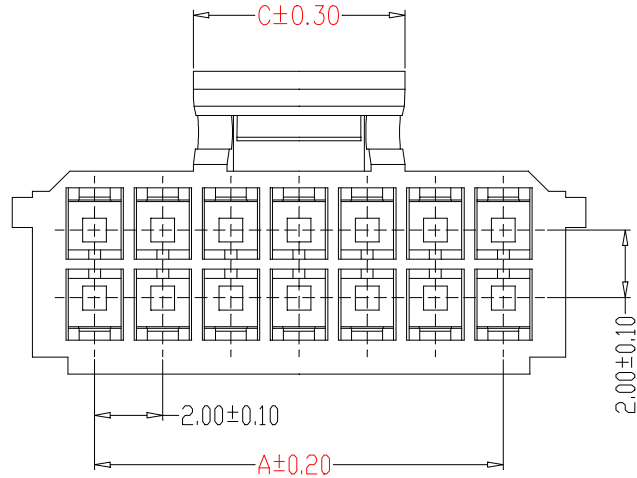
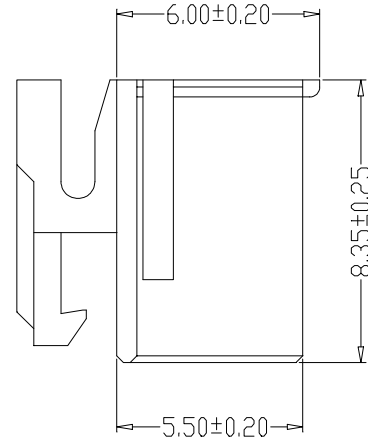
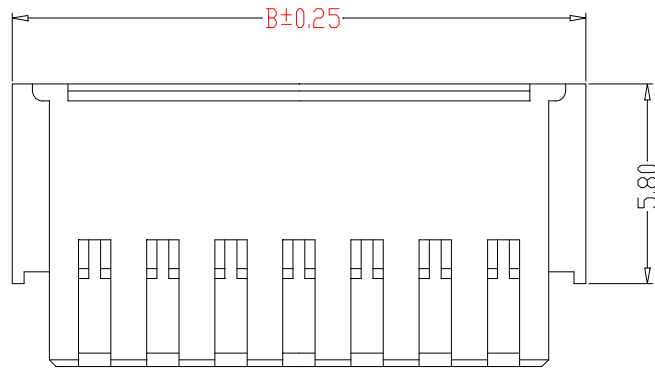

SPECIFICATIONS

- 1、Current Rating: 3A AC, DC
- 2、Voltage Rating: 250V AC, DC
- 3、Temperatuer Range: -25℃~+85℃
- 4、Contact Resistance: 20mΩ Max
- 5、Insulation Resistance: 1000 MΩ Min
- 6、Withstanding Voltang: 800V AC/minute
- 7、Material:Nylon66,UL94V-0

Circuit	Part NO.	Dimensions mm		
		A	B	C
2	HC-PHB-2x2Y	2.00	7.00	3.00
3	HC-PHB-2x3Y	4.00	9.00	3.00
4	HC-PHB-2x4Y	6.00	11.00	5.30
5	HC-PHB-2x5Y	8.00	13.00	6.30
6	HC-PHB-2x6Y	10.00	15.00	8.30
7	HC-PHB-2x7Y	12.00	17.00	8.30
8	HC-PHB-2x8Y	14.00	19.00	12.30
9	HC-PHB-2x9Y	16.00	21.00	12.30
10	HC-PHB-2x10Y	18.00	23.00	12.30
11	HC-PHB-2x11Y	20.00	25.00	16.30
12	HC-PHB-2x12Y	22.00	27.00	16.30
13	HC-PHB-2x13Y	24.00	29.00	16.30
14	HC-PHB-2x14Y	26.00	31.00	16.30
15	HC-PHB-2x15Y	28.00	33.00	16.30
16	HC-PHB-2x16Y	30.00	35.00	16.30
17	HC-PHB-2x17Y	32.00	37.00	16.30
18	HC-PHB-2x18Y	34.00	39.00	16.30
19	HC-PHB-2x19Y	36.00	41.00	16.30
20	HC-PHB-2x20Y	38.00	43.00	16.30

			GENEERL TOLERANCE	制图 DRAWING	 深圳市华灿天禄电子有限公司 ShenzhenhuacantianluELECTRONICS CO.,LTD			
			DIM TOL	审核 CHECK				
			X.X ±0.30	批准 APPROVAL	产品名称 TITLE	双排孔座	版本 REV.	A
			X.XX ±0.20	比例 SCALE	产品料号 PART NO.	HC-PHB-2xNY	单位 UNITS	mm
			X.XXX ±0.10	投影 Projection	材料 MATERIAL		页次 SHEET	1/1
1	初版发行	日期	Angle ±3.0°					
序号 No.	变更内容 MODIFY CONTENT	日期 MODIFY DATE						

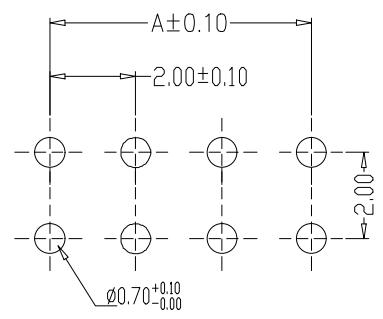
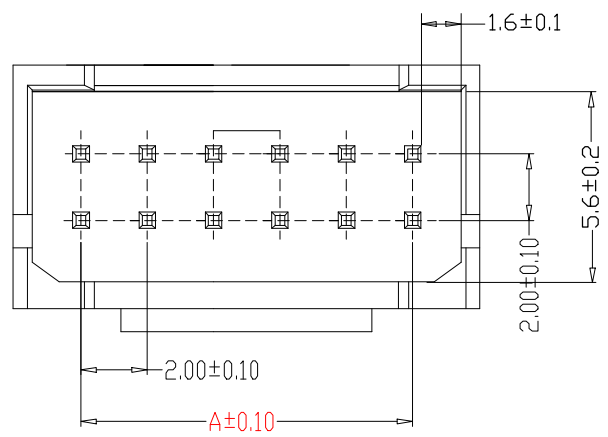
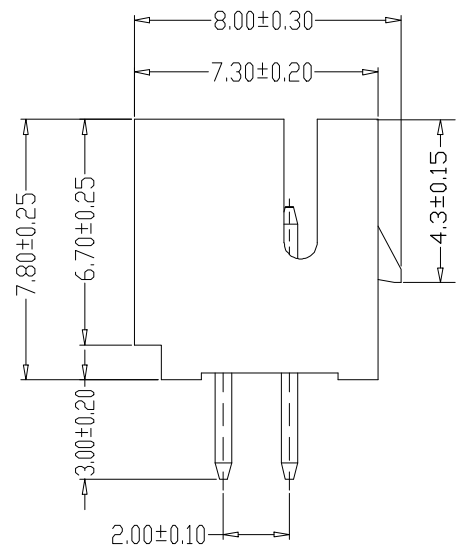
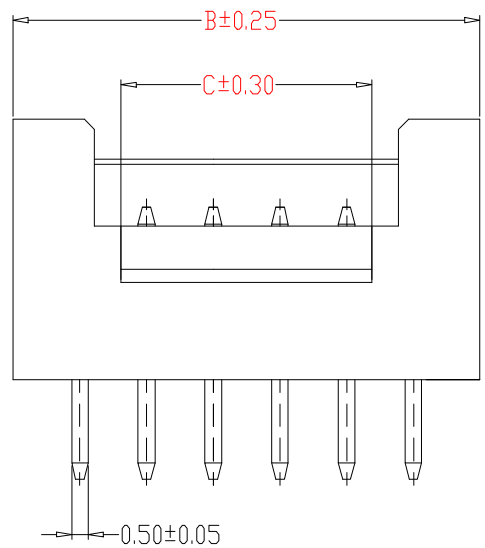

PCB LAYOUT

SPECIFICATIONS

- 1、Current Rating: 3A AC, DC
- 2、Voltage Rating: 250V AC, DC
- 3、Temperatuer Range: -25℃~+85℃
- 4、Contact Resistance: 20mΩ Max
- 5、Insulation Resistance: 1000MΩ Min
- 6、Withstanding Voltang: 800V AC/minute
- 7、Material: Wafer Nylon66, UL94V-0
PIN Brass(H65) Tin-plated

Circuit	Part NO.	Dimensions mm		
		A	B	C
2	HC-PHB-2x02A	2.00	6.00	3.00
3	HC-PHB-2x03A	4.00	8.00	3.00
4	HC-PHB-2x04A	6.00	10.00	3.00
5	HC-PHB-2x05A	8.00	12.00	5.00
6	HC-PHB-2x06A	10.00	14.00	7.00
7	HC-PHB-2x07A	12.00	16.00	9.00
8	HC-PHB-2x08A	14.00	18.00	11.00
9	HC-PHB-2x09A	16.00	20.00	13.00
10	HC-PHB-2x10A	18.00	22.00	15.00
11	HC-PHB-2x11A	20.00	24.00	17.00
12	HC-PHB-2x12A	22.00	26.00	19.00
13	HC-PHB-2x13A	24.00	28.00	21.00
14	HC-PHB-2x14A	26.00	30.00	23.00
15	HC-PHB-2x15A	28.00	32.00	25.00
16	HC-PHB-2x16A	30.00	34.00	27.00
17	HC-PHB-2x17A	32.00	36.00	29.00
18	HC-PHB-2x18A	34.00	38.00	31.00
19	HC-PHB-2x19A	36.00	40.00	33.00
20	HC-PHB-2x20A	38.00	42.00	35.00

			GENEERL TOLERANCE		制图 DRAWING		 深圳市华灿天禄电子有限公司 ShenzhenhuacantianluELECTRONICS CO.,LTD			
			DIM	TOL	审核 CHECK					
			X.X	±0.30	批准 APPROVAL		产品名称 TITLE	双排直针	版本 REV.	A
			X.XX	±0.20	比例 SCALE		产品料号 PART NO.	HC-PHB-2xNA	单位 UNITS	mm
			X.XXX	±0.10	投影 Projection		材料 MATERIAL		页次 SHEET	1/1
序号 No.	变更内容 MODIFY CONTENT	日期 MODIFY DATE	Angle ±3.0°							

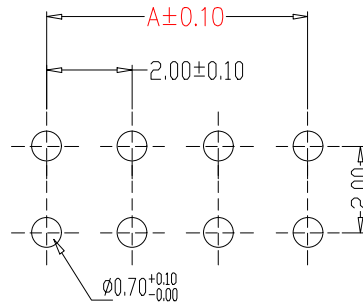
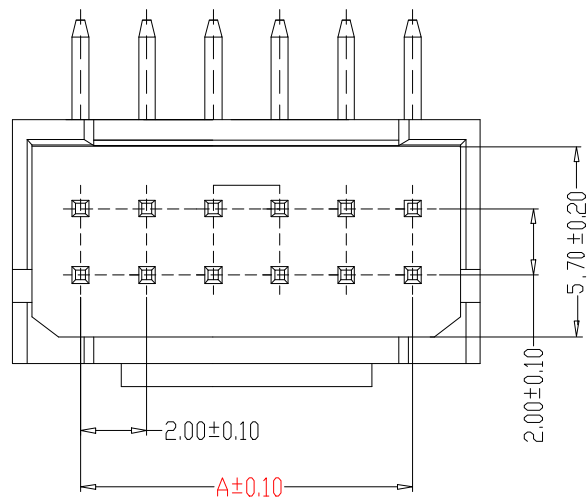
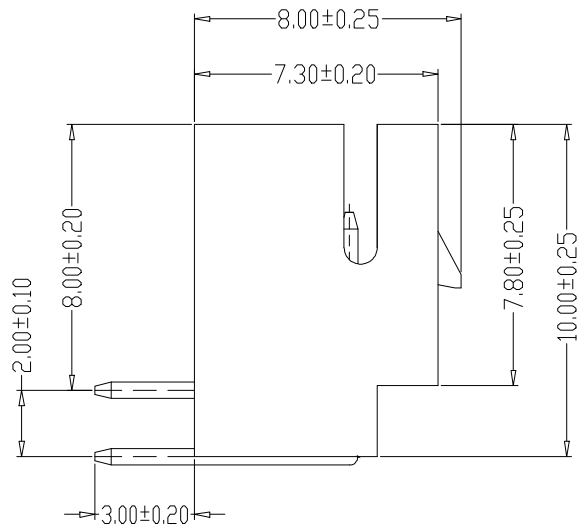
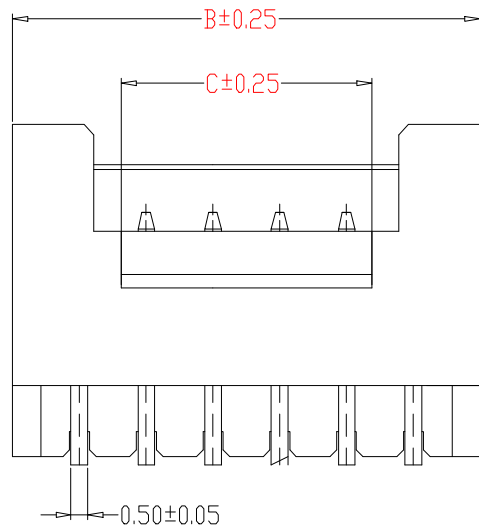

PCB LAYOUT

SPECIFICATIONS

- 1、Current Rating: 3A AC, DC
- 2、Voltage Rating: 250V AC, DC
- 3、Temperatuer Range: -25℃~+85℃
- 4、Contact Resistance: 20mΩ Max
- 5、Insulation Resistance: 1000MΩ Min
- 6、Withstanding Voltang: 800V AC/minute
- 7、Material:Wafer Nylon66, UL94V-0
PIN Brass(H65) Tin-plated

Circuit	Part NO.	Dimensions mm		
		A	B	C
2	HC-PHB-2x02AW	2.00	6.00	3.00
3	HC-PHB-2x03AW	4.00	8.00	3.00
4	HC-PHB-2x04AW	6.00	10.00	3.00
5	HC-PHB-2x05AW	8.00	12.00	5.00
6	HC-PHB-2x06AW	10.00	14.00	7.00
7	HC-PHB-2x07AW	12.00	16.00	9.00
8	HC-PHB-2x08AW	14.00	18.00	11.00
9	HC-PHB-2x09AW	16.00	20.00	13.00
10	HC-PHB-2x10AW	18.00	22.00	15.00
11	HC-PHB-2x11AW	20.00	24.00	17.00
12	HC-PHB-2x12AW	22.00	26.00	19.00
13	HC-PHB-2x13AW	24.00	28.00	21.00
14	HC-PHB-2x14AW	26.00	30.00	23.00
15	HC-PHB-2x15AW	28.00	32.00	25.00
16	HC-PHB-2x16AW	30.00	34.00	27.00
17	HC-PHB-2x17AW	32.00	36.00	29.00
18	HC-PHB-2x18AW	34.00	38.00	31.00
19	HC-PHB-2x19AW	36.00	40.00	33.00
20	HC-PHB-2x20AW	38.00	42.00	35.00

			GENEAL TOLERANCE	制图 DRAWING	深圳市华灿天禄电子有限公司 ShenzhenhuacantianluELECTRONICS CO., LTD			
			DIM TOL	审核 CHECK	产品名称 TITLE	双排弯针	版本 REV.	A
			X.X ±0.30	批准 APPROVAL	产品料号 PART NO.	HC-PHB-2xNAW	单位 UNITS	mm
			X.XX ±0.20	投影 Projection	材料 MATERIAL		页次 SHEET	1/1
			X.XXX ±0.10					
1	初版发行	日期	Angle ±3.0°					
序号 No.	变更内容 MODIFY CONTENT	日期 MODIFY DATE						

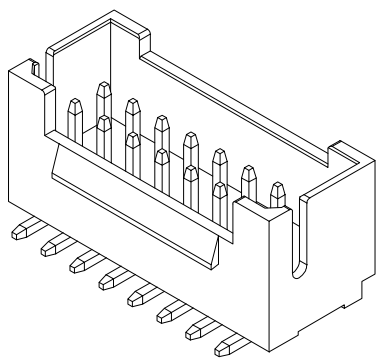
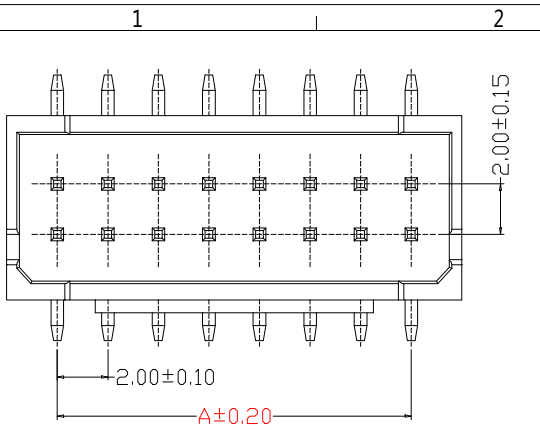

SPECIFICATIONS

- 1、Current Rating: 3A AC, DC
- 2、Voltage Rating: 250V AC, DC
- 3、Temperatuer Range: -25℃~+85℃
- 4、Contact Resistance: 20mΩ Max
- 5、Insulation Resistance: 1000MΩ Min
- 6、Withstanding Voltang: 800V AC/minute
- 7、Material: Wafer LCP, UL94V-0
PIN Brass Tin-plated

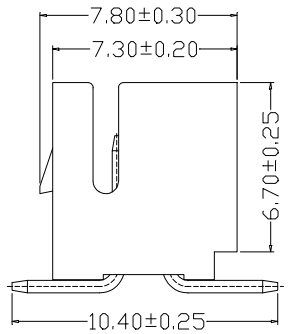
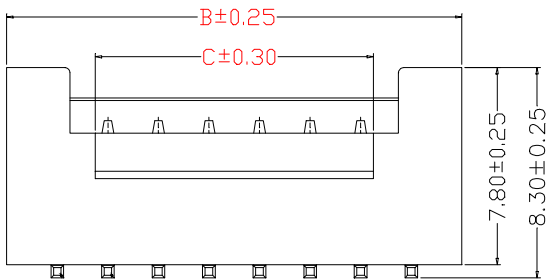

Circuit	Part NO.	Dimensions mm		
		A	B	C
2	HC-PHB-2x2ALT	2.00	6.00	3.00
3	HC-PHB-2x3ALT	4.00	8.00	3.00
4	HC-PHB-2x4ALT	6.00	10.00	3.00
5	HC-PHB-2x5ALT	8.00	12.00	5.00
6	HC-PHB-2x6ALT	10.00	14.00	7.00
7	HC-PHB-2x7ALT	12.00	16.00	9.00
8	HC-PHB-2x8ALT	14.00	18.00	11.00
9	HC-PHB-2x9ALT	16.00	20.00	13.00
10	HC-PHB-2x10ALT	18.00	22.00	15.00
11	HC-PHB-2x11ALT	20.00	24.00	17.00
12	HC-PHB-2x12ALT	22.00	26.00	19.00
13	HC-PHB-2x13ALT	24.00	28.00	21.00
14	HC-PHB-2x14ALT	26.00	30.00	23.00
15	HC-PHB-2x15ALT	28.00	32.00	25.00
16	HC-PHB-2x16ALT	30.00	34.00	27.00
17	HC-PHB-2x17ALT	32.00	36.00	29.00
18	HC-PHB-2x18ALT	34.00	38.00	31.00
19	HC-PHB-2x19ALT	36.00	40.00	33.00
20	HC-PHB-2x20ALT	38.00	42.00	35.00

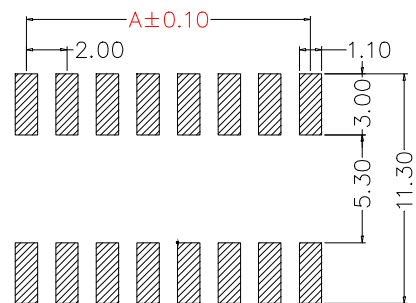
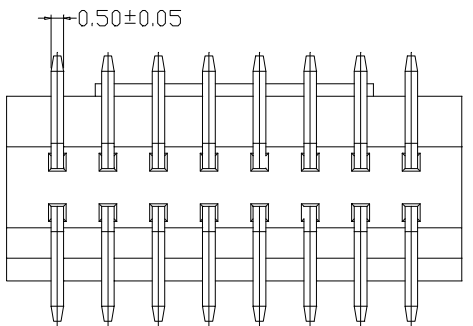

PCB LAYOUT

			GENERAL TOLERANCE	制图 DRAWING	深圳市华灿天禄电子有限公司 ShenzhenhuacantianluELECTRONICS CO., LTD			
			DIM TOL	审核 CHECK	产品名称 TITLE	双排立贴	版本 REV.	A
			X.X ±0.30	批准 APPROVAL	产品料号 PART NO.	HC-PHB-2xNALT	单位 UNITS	mm
1	初版发行		X.XX ±0.20	比例 SCALE	材料 MATERIAL		页次 SHEET	1/1
序号 No.	变更内容 MODIFY CONTENT	日期 MODIFY DATE	X.XXX ±0.10	投影 Projection				
			Angle ±3.0°					

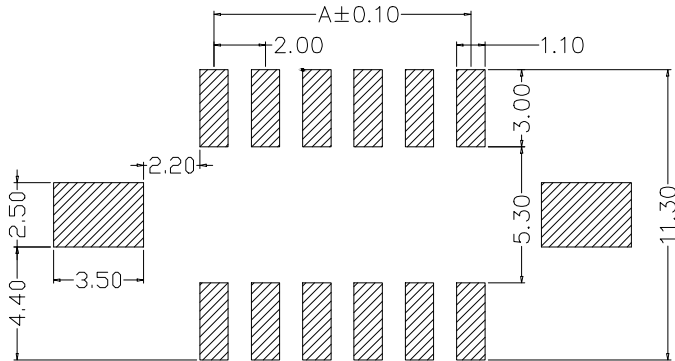
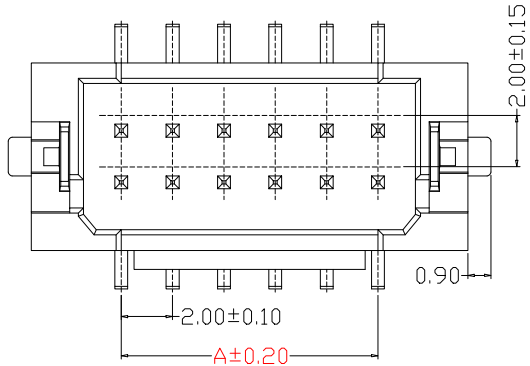

PCB LAYOUT

SPECIFICATIONS

- 1、Current Rating: 3A AC, DC
- 2、Voltage Rating: 250V AC, DC
- 3、Temperatuer Range: -25℃~+85℃
- 4、Contact Resistance: 20mΩ Max
- 5、Insulation Resistance: 1000MΩ Min
- 6、Withstanding Voltang: 800V AC/minute
- 7、Material:Wafer LCP,UL94V-0
PIN Brass Tin-plated

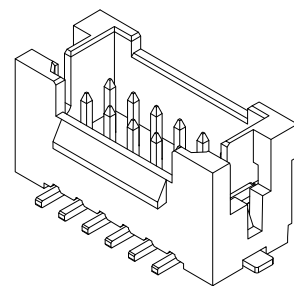
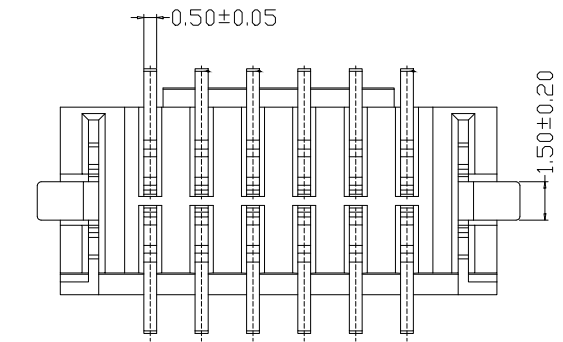
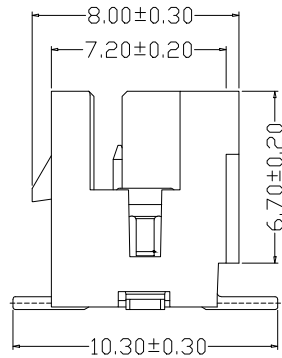
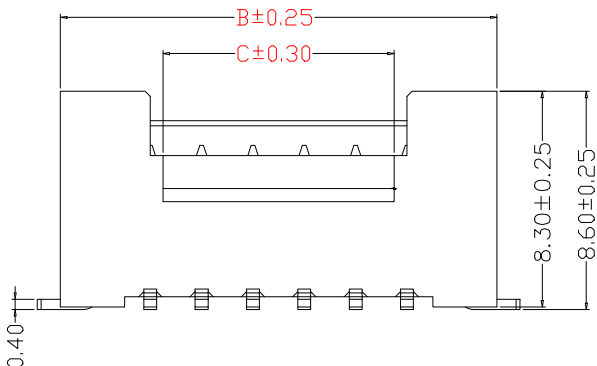

Circuit	Part NO.	Dimensions mm		
		A	B	C
2	HC-PHB-2x2ALT-B	2.00	9.00	3.00
3	HC-PHB-2x3ALT-B	4.00	11.00	3.00
4	HC-PHB-2x4ALT-B	6.00	13.00	3.00
5	HC-PHB-2x5ALT-B	8.00	15.00	5.00
6	HC-PHB-2x6ALT-B	10.00	17.00	7.00
7	HC-PHB-2x7ALT-B	12.00	19.00	9.00
8	HC-PHB-2x8ALT-B	14.00	21.00	11.00
9	HC-PHB-2x9ALT-B	16.00	23.00	13.00
10	HC-PHB-2x10ALT-B	18.00	25.00	15.00
11	HC-PHB-2x11ALT-B	20.00	27.00	17.00
12	HC-PHB-2x12ALT-B	22.00	29.00	19.00
13	HC-PHB-2x13ALT-B	24.00	31.00	21.00
14	HC-PHB-2x14ALT-B	26.00	33.00	23.00
15	HC-PHB-2x15ALT-B	28.00	35.00	25.00
16	HC-PHB-2x16ALT-B	30.00	37.00	27.00
17	HC-PHB-2x17ALT-B	32.00	39.00	29.00
18	HC-PHB-2x18ALT-B	34.00	41.00	31.00
19	HC-PHB-2x19ALT-B	36.00	43.00	33.00
20	HC-PHB-2x20ALT-B	38.00	45.00	35.00

			GENERAL TOLERANCE	制图 DRAWING				
			DIM TOL	审核 CHECK				
			X.X ±0.30	批准 APPROVAL	产品名称 TITLE	双排立贴-B款	版本 REV.	A
1	初版发行		X.XX ±0.20	比例 SCALE	产品料号 PART NO.	HC-PHB-2xNALT-B	单位 UNITS	mm
序号 No.	变更内容 MODIFY CONTENT	日期 MODIFY DATE	X.XXX ±0.10	投影 Projection	材料 MATERIAL		页次 SHEET	1/1
			Angle ±3.0°					

深圳市华灿天禄电子有限公司
ShenzhenhuacantianluELECTRONICS CO.,LTD

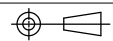

SPECIFICATIONS

- 1、Current Rating: 3A AC, DC
- 2、Voltage Rating: 250V AC, DC
- 3、Temperatuer Range: -25℃~+85℃
- 4、Contact Resistance: 20mΩ Max
- 5、Insulation Resistance: 1000MΩ Min
- 6、Withstanding Voltang: 800V AC/minute
- 7、Material: Wafer LCP, ULS4V-0
PIN Brass Tin-plated

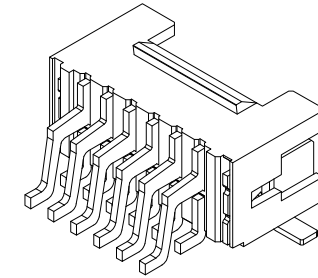

Circuit	Part NO.	Dimensions mm			
		A	B	C	D
2	HC-PHB-2x2AWT	2.00	4.90	3.00	9.00
3	HC-PHB-2x3AWT	4.00	6.90	3.00	11.00
4	HC-PHB-2x4AWT	6.00	8.90	3.00	13.00
5	HC-PHB-2x5AWT	8.00	10.90	5.00	15.00
6	HC-PHB-2x6AWT	10.00	12.90	7.00	17.00
7	HC-PHB-2x7AWT	12.00	14.90	9.00	19.00
8	HC-PHB-2x8AWT	14.00	16.90	11.00	21.00
9	HC-PHB-2x9AWT	16.00	18.90	13.00	23.00
10	HC-PHB-2x10AWT	18.00	20.90	15.00	25.00
11	HC-PHB-2x11AWT	20.00	22.90	17.00	27.00
12	HC-PHB-2x12AWT	22.00	24.90	19.00	29.00
13	HC-PHB-2x13AWT	24.00	26.90	21.00	31.00
14	HC-PHB-2x14AWT	26.00	28.90	23.00	33.00
15	HC-PHB-2x15AWT	28.00	30.90	25.00	35.00
16	HC-PHB-2x16AWT	30.00	32.90	27.00	37.00
17	HC-PHB-2x17AWT	32.00	34.90	29.00	39.00
18	HC-PHB-2x18AWT	34.00	36.90	31.00	41.00
19	HC-PHB-2x19AWT	36.00	38.90	33.00	43.00
20	HC-PHB-2x20AWT	38.00	40.90	35.00	45.00

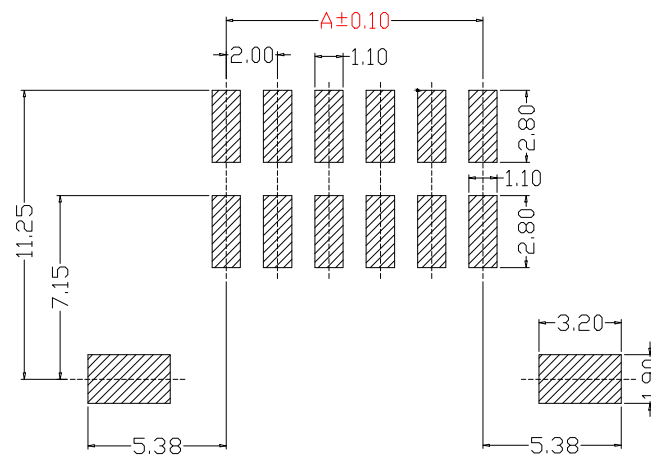

PCB LAYOUT

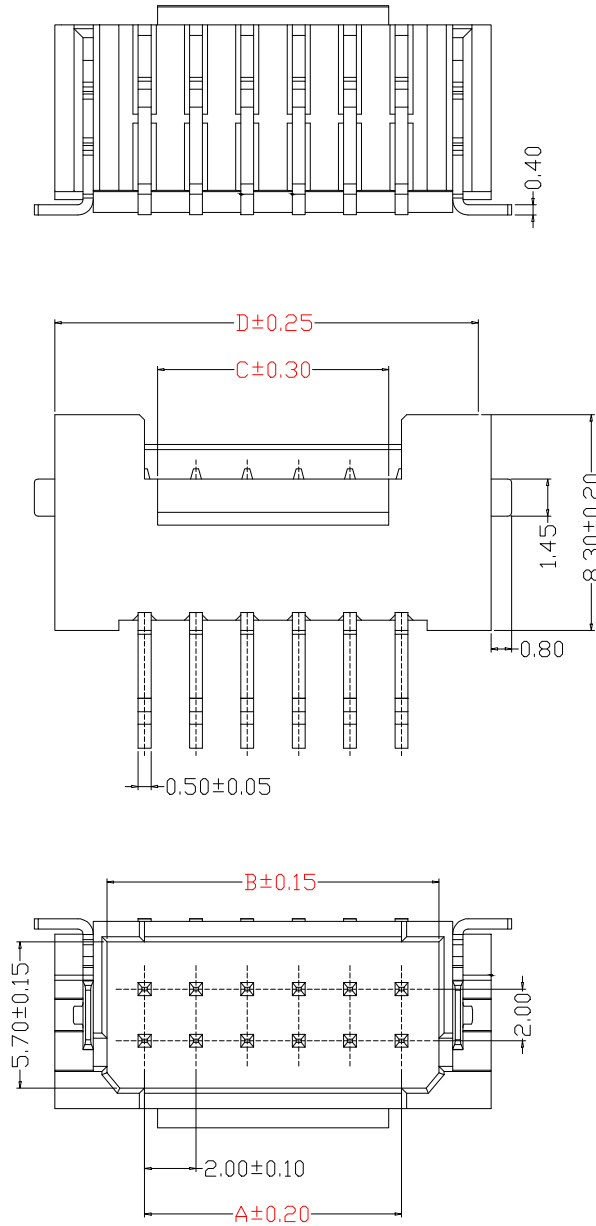

		GENERAL TOLERANCE		制图 DRAWING	
		DIM	TOL	审核 CHECK	
		X.X	±0.30	批准 APPROVAL	
		X.XX	±0.20	比例 SCALE	
		X.XXX	±0.10	投影 Projection	
		Angle	±3.0°		
1	初版发行				
序号 No.	变更内容 MODIFY CONTENT	日期 MODIFY DATE			

 深圳市华灿天禄电子有限公司
ShenzhenhuacantianluELECTRONICS CO.,LTD

产品名称 TITLE	双排卧贴	版本 REV.	A
产品料号 PART NO.	HC-PHB-2xNAWT	单位 UNITS	mm
材料 MATERIAL		页次 SHEET	1/1

X-ON Electronics

Largest Supplier of Electrical and Electronic Components

Click to view similar products for [Headers & Wire Housings](#) category:

Click to view products by [HCTL](#) manufacturer:

Other Similar products are found below :

[57102-F02-18ULF](#) [58102-G61-06LF](#) [582553-1](#) [009176003701906](#) [01.001.5753.1](#) [0050291907](#) [02.125.8002.8](#) [609-3404](#) [61062-3](#)
[CSU011177004](#) [622-0430](#) [622-3653LF](#) [63453-116](#) [636-1030](#) [636-1427](#) [636-3427](#) [636-4007](#) [641938-9](#) [65495-038](#) [65692-001LF](#) [65781-018](#)
[65781-047](#) [65817-010LF](#) [65817-015LF](#) [66207-023LF](#) [67095-007LF](#) [67601157](#) [68631-112](#) [699319-000](#) [M90C108951C](#) [70.362.1628.0](#) [70-](#)
[4210](#) [70-4226B](#) [70-4853B](#) [707-5028](#) [71.350.2428.0](#) [71961-016LF](#) [733-134](#) [733-162](#) [754199-000](#) [760-3052](#) [80.063.4001.1](#) [800-90-001-10-](#)
[001000](#) [801-43-002-10-013000](#) [801-43-006-10-002000](#) [803-41-018-10-001000](#) [803-43-024-10-001000](#) [803-93-012-10-001000](#) [8-1437020-4](#)
[819-22-004-30-001101](#)