

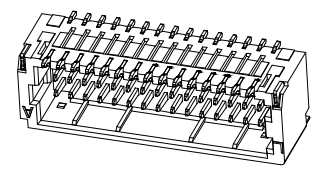

Specifications:
 Poles:10 to 50
 Contact resistance:≤20mΩ
 Insulation resistance:≥100MΩ
 Rated voltage:50V AC DC
 Rated current:1.0A AC DC(AWG#28)
 Withstand Voltage: 500V AC/minute
 Temperature Range:-25°C~ +85°C
 Housing:PA9T UL94V-0,Natural(Beige)
 Contacts:Phosphor Bronze Au/Sn-plated
 Solder Tabs:Brass Sn-plated

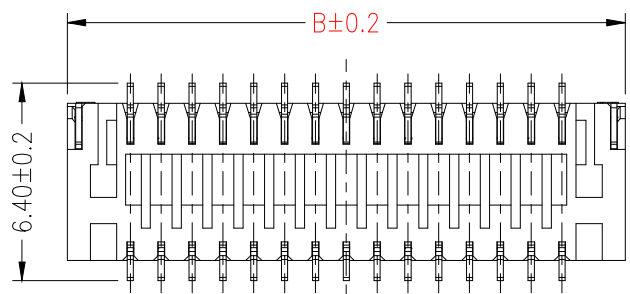
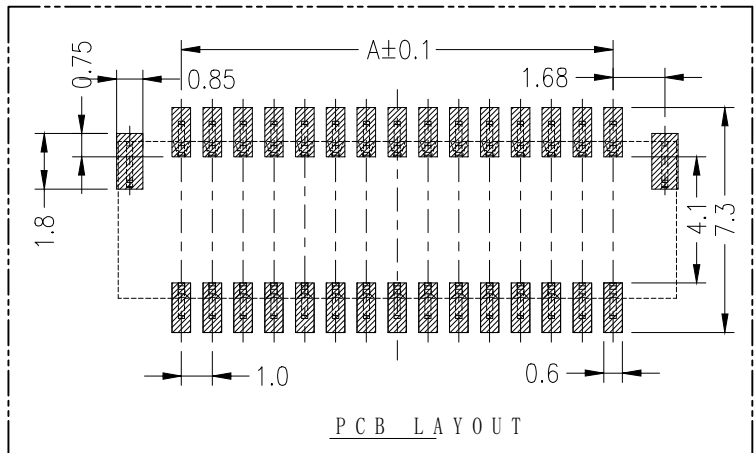
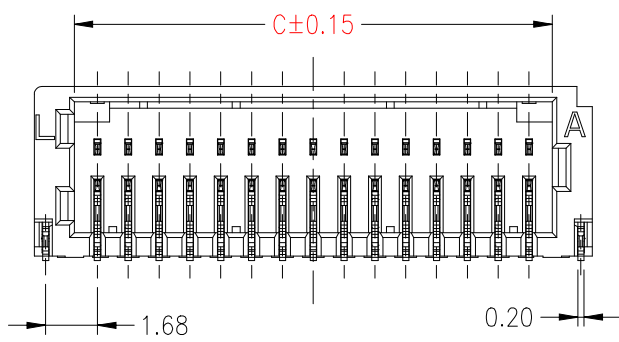

Circuit	Part NO.	Dimensions mm		
		A	B	C
5	HC-SHD-2x5PWT-G-04	4.00	8.10	5.50
6	HC-SHD-2x6PWT-G-04	5.00	9.10	6.50
7	HC-SHD-2x7PWT-G-04	6.00	10.10	7.50
8	HC-SHD-2x8PWT-G-04	7.00	11.10	8.50
9	HC-SHD-2x9PWT-G-04	8.00	12.10	9.50
10	HC-SHD-2x10PWT-G-04	9.00	13.10	10.50
15	HC-SHD-2x15PWT-G-04	14.00	18.10	15.50
20	HC-SHD-2x20PWT-G-04	19.00	23.10	20.50
25	HC-SHD-2x25PWT-G-04	24.00	28.10	25.50

Circuits	pcs/box	boxs/Carton	Pcs/Box
2x5~2x10 Pin	900	15	13500
2x15 Pin	900	11	9900
2x20~2x25 Pin	900	8	7200

GENREL TOLERANCE		制图 DRAWING
DIM	TOL	审核 CHECK
X.X	±0.30	批准 APPROVAL
X.XX	±0.20	比例 SCALE
X.XXX	±0.10	投影 Projection
Angle	±3.0°	



深圳市华灿天禄电子有限公司
 ShenzhenhuacantianluELECTRONICS CO.,LTD

产品名称 TITLE	1.0 双排 卧贴 (Au)	版本 REV.	A
产品料号 PART NO.	HC-SHD-2xNPWT-G-04	单位 UNITS	mm
材料 MATERIAL		页次 SHEET	1/1

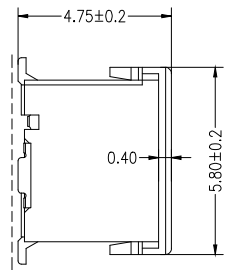
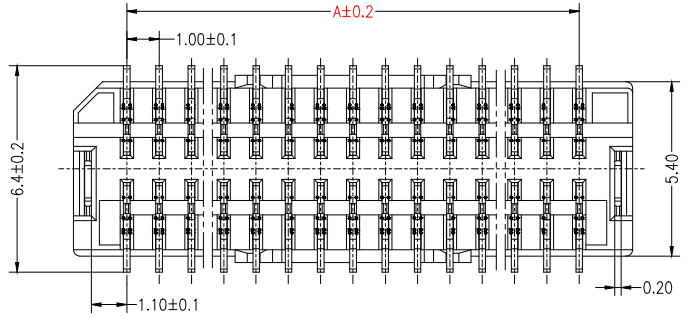
序号 No.	变更内容 MODIFY CONTENT	日期 MODIFY DATE
1	初版发行	

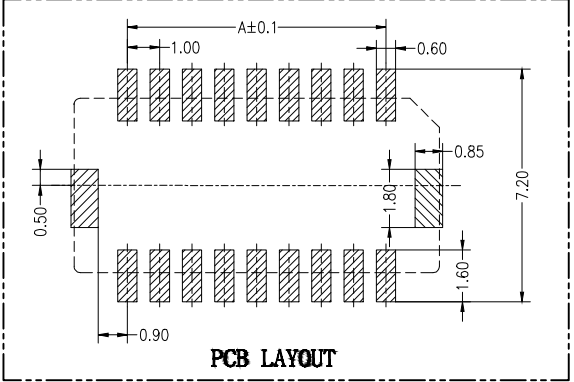
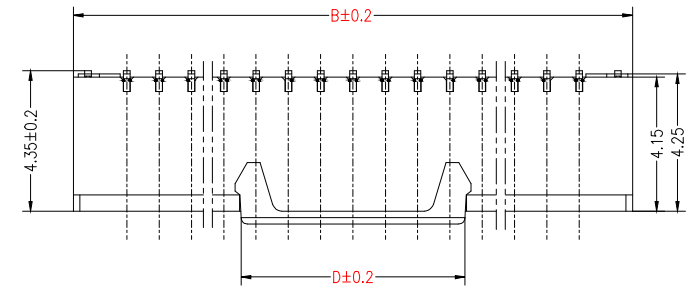

0.12



PCB LAYOUT

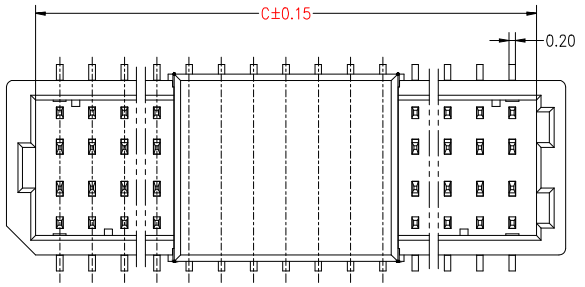

Specifications

- Poles : 4 to 50
- Contact resistance : $\leq 20m\Omega$
- Insulation resistance : $\geq 100M\Omega$
- Rated voltage : 50V AC DC
- Rated current : 1.0A AC DC (AWG28#线)
- Withstand Voltage : 500V AC/minute
- Temperature Range : -25°C ~ +85°C

Circuit	Part NO.	Dimensions mm				
		A	B	C	D	
2	HC-SHD-2x2PLT-G-04	1.00	4.30	2.50		麦拉
3	HC-SHD-2x3PLT-G-04	2.00	5.30	3.50		
4	HC-SHD-2x4PLT-G-04	3.00	6.30	4.50		
5	HC-SHD-2x5PLT-G-04	4.00	7.30	5.50		
6	HC-SHD-2x6PLT-G-04	5.00	8.30	6.50		4.00
7	HC-SHD-2x7PLT-G-04	6.00	9.30	7.50		
8	HC-SHD-2x8PLT-G-04	7.00	10.30	8.50		
9	HC-SHD-2x9PLT-G-04	8.00	11.30	9.50		
10	HC-SHD-2x10PLT-G-04	9.00	12.30	10.50		7.00
11	HC-SHD-2x11PLT-G-04	10.00	13.30	11.50		
12	HC-SHD-2x12PLT-G-04	11.00	14.30	12.50		
14	HC-SHD-2x14PLT-G-04	13.00	16.30	14.50		
15	HC-SHD-2x15PLT-G-04	14.00	17.30	15.50		
16	HC-SHD-2x16PLT-G-04	15.00	18.30	16.50		
18	HC-SHD-2x18PLT-G-04	17.00	20.30	18.50		
20	HC-SHD-2x20PLT-G-04	19.00	22.30	20.50		
25	HC-SHD-2x25PLT-G-04	24.00	27.30	25.50		

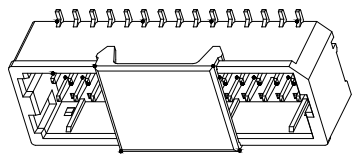
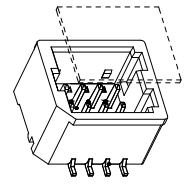

Circuits	pcs/box	boxes/Carton	Pcs/Box
2x2~2x5 Pin	1000	20	20000
2x6~2x12 Pin	1000	15	15000
2x14~2x18 Pin	1000	11	11000
2x20~2x25 Pin	1000	8	8000

GENERAL TOLERANCE		制图	深圳市华灿天禄电子有限公司		
DIM	TOL	DRAWING	ShenzhenhuacantianluELECTRONICS CO.,LTD		
X.X	±0.30	审核	产品名称	1.0 双排 立贴 (Au)	版本
X.XX	±0.20	CHECK	TITLE		REV.
X.XXX	±0.10	批准	产品料号	HC-SHD-2xNPLT-G-04	单位
Angle	±3.0°	APPROVAL	PART NO.		UNITS
		比例			mm
序号	变更内容	日期	材料		页次
No.	MODIFY CONTENT	MODIFY DATE	MATERIAL		SHEET

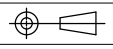

材料		页次	1/1
----	--	----	-----

X-ON Electronics

Largest Supplier of Electrical and Electronic Components

Click to view similar products for [Headers & Wire Housings](#) category:

Click to view products by [HCTL](#) manufacturer:

Other Similar products are found below :

[57102-F02-18ULF](#) [58102-G61-06LF](#) [582553-1](#) [009176003701906](#) [01.001.5753.1](#) [0050291907](#) [02.125.8002.8](#) [609-3404](#) [61062-3](#)
[CSU011177004](#) [622-0430](#) [622-3653LF](#) [63453-116](#) [636-1030](#) [636-1427](#) [636-3427](#) [636-4007](#) [641938-9](#) [65495-038](#) [65692-001LF](#) [65781-018](#)
[65781-047](#) [65817-010LF](#) [65817-015LF](#) [66207-023LF](#) [67095-007LF](#) [67601157](#) [68631-112](#) [68645-018](#) [699319-000](#) [M90C108951C](#)
[70.362.1628.0](#) [70-4210](#) [70-4226B](#) [70-4853B](#) [707-5028](#) [71.350.2428.0](#) [71961-016LF](#) [733-134](#) [733-162](#) [754199-000](#) [760-3052](#) [80.063.4001.1](#)
[800-90-001-10-001000](#) [800-90-010-10-002000](#) [801-43-002-10-013000](#) [801-43-006-10-002000](#) [803-41-018-10-001000](#) [803-43-024-10-](#)
[001000](#) [803-93-012-10-001000](#)