

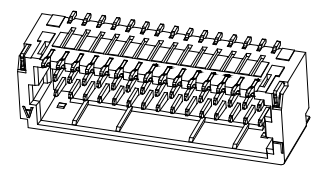

Specifications:  
 Poles:10 to 50  
 Contact resistance:≤20mΩ  
 Insulation resistance:≥100MΩ  
 Rated voltage:50V AC DC  
 Rated current:1.0A AC DC(AWG#28)  
 Withstand Voltage: 500V AC/minute  
 Temperature Range:-25°C~ +85°C  
 Housing:PA9T UL94V-0,Natural(Beige)  
 Contacts:Phosphor Bronze Au/Sn-plated  
 Solder Tabs:Brass Sn-plated

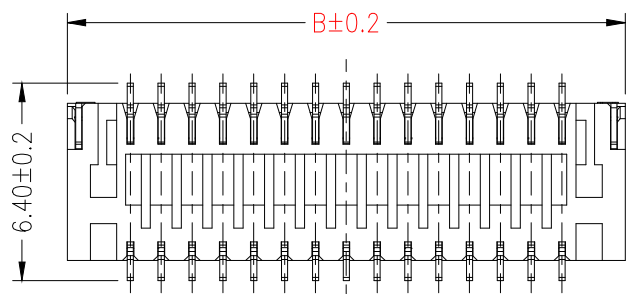
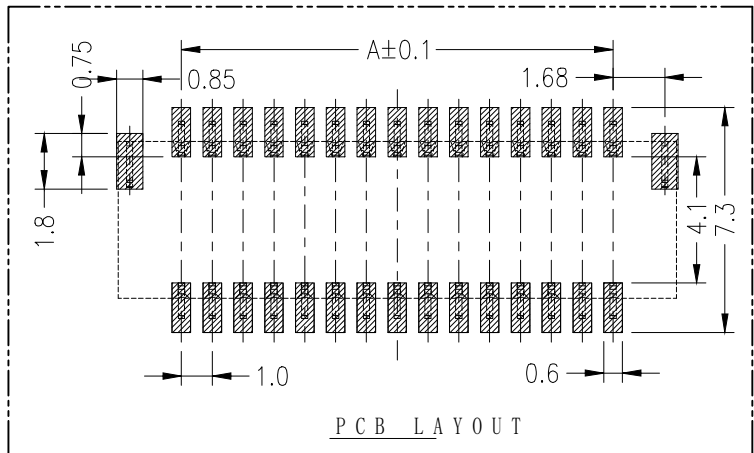
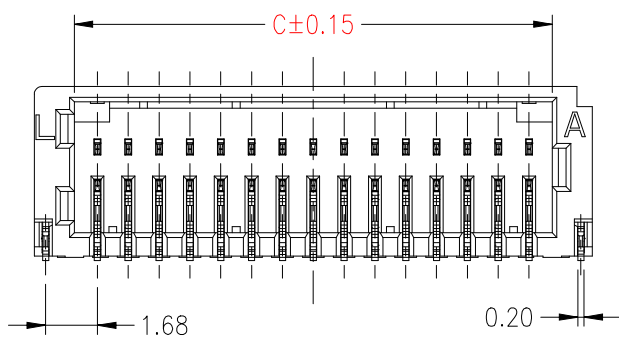

| Circuit | Part NO.            | Dimensions mm |       |       |
|---------|---------------------|---------------|-------|-------|
|         |                     | A             | B     | C     |
| 5       | HC-SHD-2x5PWT-G-04  | 4.00          | 8.10  | 5.50  |
| 6       | HC-SHD-2x6PWT-G-04  | 5.00          | 9.10  | 6.50  |
| 7       | HC-SHD-2x7PWT-G-04  | 6.00          | 10.10 | 7.50  |
| 8       | HC-SHD-2x8PWT-G-04  | 7.00          | 11.10 | 8.50  |
| 9       | HC-SHD-2x9PWT-G-04  | 8.00          | 12.10 | 9.50  |
| 10      | HC-SHD-2x10PWT-G-04 | 9.00          | 13.10 | 10.50 |
| 15      | HC-SHD-2x15PWT-G-04 | 14.00         | 18.10 | 15.50 |
| 20      | HC-SHD-2x20PWT-G-04 | 19.00         | 23.10 | 20.50 |
| 25      | HC-SHD-2x25PWT-G-04 | 24.00         | 28.10 | 25.50 |

| Circuits      | pcs/box | boxs/Carton | Pcs/Box |
|---------------|---------|-------------|---------|
| 2x5~2x10 Pin  | 900     | 15          | 13500   |
| 2x15 Pin      | 900     | 11          | 9900    |
| 2x20~2x25 Pin | 900     | 8           | 7200    |

| GENREL TOLERANCE |       | 制图<br>DRAWING    |
|------------------|-------|------------------|
| DIM              | TOL   | 审核<br>CHECK      |
| X.X              | ±0.30 | 批准<br>APPROVAL   |
| X.XX             | ±0.20 | 比例<br>SCALE      |
| X.XXX            | ±0.10 | 投影<br>Projection |
| Angle            | ±3.0° |                  |



**深圳市华灿天禄电子有限公司**  
 ShenzhenhuacantianluELECTRONICS CO.,LTD

|                  |                    |             |     |
|------------------|--------------------|-------------|-----|
| 产品名称<br>TITLE    | 1.0 双排 卧贴 (Au)     | 版本<br>REV.  | A   |
| 产品料号<br>PART NO. | HC-SHD-2xNPWT-G-04 | 单位<br>UNITS | mm  |
| 材料<br>MATERIAL   |                    | 页次<br>SHEET | 1/1 |

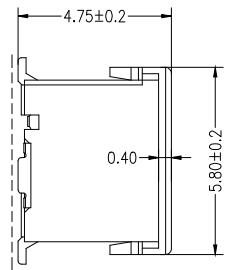
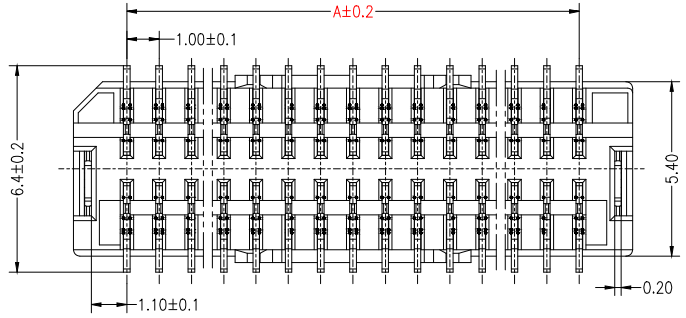
| 序号<br>No. | 变更内容<br>MODIFY CONTENT | 日期<br>MODIFY DATE |
|-----------|------------------------|-------------------|
| 1         | 初版发行                   |                   |

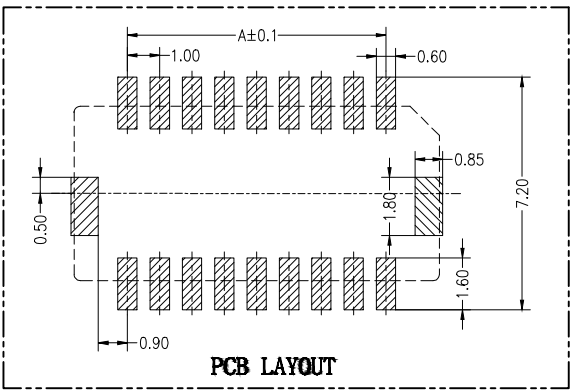
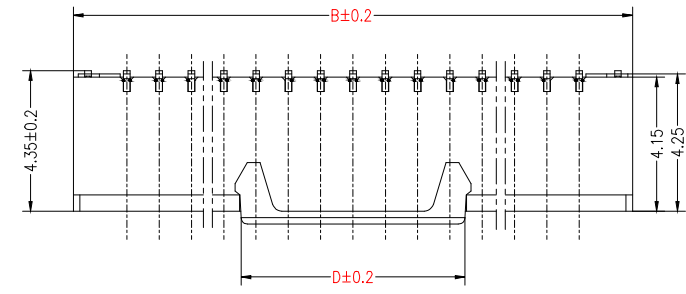

0.12



PCB LAYOUT

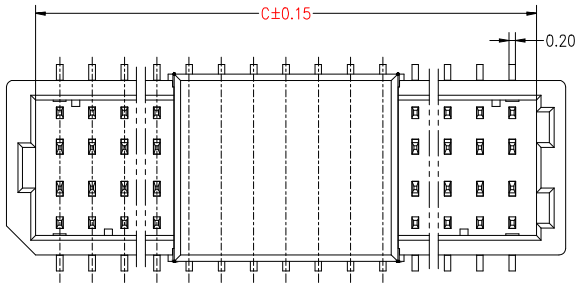

### Specifications

- Poles : 4 to 50
- Contact resistance :  $\leq 20m\Omega$
- Insulation resistance :  $\geq 100M\Omega$
- Rated voltage : 50V AC DC
- Rated current : 1.0A AC DC (AWG28#线)
- Withstand Voltage : 500V AC/minute
- Temperature Range : -25°C ~ +85°C

| Circuit | Part NO.            | Dimensions mm |       |       |   |      |
|---------|---------------------|---------------|-------|-------|---|------|
|         |                     | A             | B     | C     | D |      |
| 2       | HC-SHD-2x2PLT-G-04  | 1.00          | 4.30  | 2.50  |   | 麦拉   |
| 3       | HC-SHD-2x3PLT-G-04  | 2.00          | 5.30  | 3.50  |   |      |
| 4       | HC-SHD-2x4PLT-G-04  | 3.00          | 6.30  | 4.50  |   |      |
| 5       | HC-SHD-2x5PLT-G-04  | 4.00          | 7.30  | 5.50  |   |      |
| 6       | HC-SHD-2x6PLT-G-04  | 5.00          | 8.30  | 6.50  |   | 4.00 |
| 7       | HC-SHD-2x7PLT-G-04  | 6.00          | 9.30  | 7.50  |   |      |
| 8       | HC-SHD-2x8PLT-G-04  | 7.00          | 10.30 | 8.50  |   |      |
| 9       | HC-SHD-2x9PLT-G-04  | 8.00          | 11.30 | 9.50  |   |      |
| 10      | HC-SHD-2x10PLT-G-04 | 9.00          | 12.30 | 10.50 |   | 7.00 |
| 11      | HC-SHD-2x11PLT-G-04 | 10.00         | 13.30 | 11.50 |   |      |
| 12      | HC-SHD-2x12PLT-G-04 | 11.00         | 14.30 | 12.50 |   |      |
| 14      | HC-SHD-2x14PLT-G-04 | 13.00         | 16.30 | 14.50 |   |      |
| 15      | HC-SHD-2x15PLT-G-04 | 14.00         | 17.30 | 15.50 |   |      |
| 16      | HC-SHD-2x16PLT-G-04 | 15.00         | 18.30 | 16.50 |   |      |
| 18      | HC-SHD-2x18PLT-G-04 | 17.00         | 20.30 | 18.50 |   |      |
| 20      | HC-SHD-2x20PLT-G-04 | 19.00         | 22.30 | 20.50 |   |      |
| 25      | HC-SHD-2x25PLT-G-04 | 24.00         | 27.30 | 25.50 |   |      |

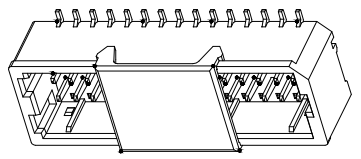
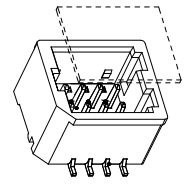

| Circuits      | pcs/box | boxes/Carton | Pcs/Box |
|---------------|---------|--------------|---------|
| 2x2~2x5 Pin   | 1000    | 20           | 20000   |
| 2x6~2x12 Pin  | 1000    | 15           | 15000   |
| 2x14~2x18 Pin | 1000    | 11           | 11000   |
| 2x20~2x25 Pin | 1000    | 8            | 8000    |

| GENERAL TOLERANCE |                | 制图          | 深圳市华灿天禄电子有限公司                           |                    |       |
|-------------------|----------------|-------------|-----------------------------------------|--------------------|-------|
| DIM               | TOL            | DRAWING     | ShenzhenhuacantianluELECTRONICS CO.,LTD |                    |       |
| X.X               | ±0.30          | 审核          | 产品名称                                    | 1.0 双排 立贴 (Au)     | 版本    |
| X.XX              | ±0.20          | CHECK       | TITLE                                   |                    | REV.  |
| X.XXX             | ±0.10          | 批准          | 产品料号                                    | HC-SHD-2xNPLT-G-04 | 单位    |
| Angle             | ±3.0°          | APPROVAL    | PART NO.                                |                    | UNITS |
|                   |                | 比例          |                                         |                    | mm    |
| 序号                | 变更内容           | 日期          | 材料                                      |                    | 页次    |
| No.               | MODIFY CONTENT | MODIFY DATE | MATERIAL                                |                    | SHEET |
|                   |                |             |                                         |                    | 1/1   |

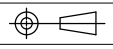

## X-ON Electronics

Largest Supplier of Electrical and Electronic Components

*Click to view similar products for [Headers & Wire Housings](#) category:*

*Click to view products by [HCTL](#) manufacturer:*

Other Similar products are found below :

[57102-F02-18ULF](#) [58102-G61-06LF](#) [582553-1](#) [009176003701906](#) [01.001.5753.1](#) [0050291907](#) [02.125.8002.8](#) [609-3404](#) [61062-3](#)  
[CSU011177004](#) [622-0430](#) [622-3653LF](#) [63453-116](#) [636-1030](#) [636-1427](#) [636-3427](#) [636-4007](#) [641938-9](#) [65495-038](#) [65692-001LF](#) [65781-018](#)  
[65781-047](#) [65817-010LF](#) [65817-015LF](#) [66207-023LF](#) [67095-007LF](#) [67601157](#) [68631-112](#) [68645-018](#) [699319-000](#) [M90C108951C](#)  
[70.362.1628.0](#) [70-4210](#) [70-4226B](#) [70-4853B](#) [707-5028](#) [71.350.2428.0](#) [71961-016LF](#) [733-134](#) [733-162](#) [754199-000](#) [760-3052](#) [80.063.4001.1](#)  
[800-90-001-10-001000](#) [800-90-010-10-002000](#) [801-43-002-10-013000](#) [801-43-006-10-002000](#) [803-41-018-10-001000](#) [803-43-024-10-](#)  
[001000](#) [803-93-012-10-001000](#)