

- 特性:
- 电气性能: ELECTRICAL
 - 额定电流: 5.0A
 - 接触阻抗: 40 MILLIOHMS MAX
 - 耐电压: 100V AC / 1 mA MAX
 - 绝缘阻抗: 150V DC/100 MEGA OHMS MIN
 - 机械性能:
 - 插入力: 5°20N ; 拨出力: 8°20N
 - 使用寿命: 10000次
 - 材料: MATERIAL
 - 电镀: FINISH
 - 端子: 接触点镀金1u~MIN
PIN脚焊接区域镀金G/F
 - 外壳: 镀镍80u~MIN
 - 电镀品需做粘锡测试; 粘锡面积达到95%以上。
 - SMT回流焊 (峰值260° C±5° C) 不能起泡、熔胶、变色不良 (变形在公差范围以内)
 - 工作温度: -55° C~+85° C
 - 盐雾测试: 通过48H在浓度为5±1%盐水的盐雾测试无生锈现象

USB TYPE-C PIN ASSIGNMENTS

PIN NUMBER	SIGNAL NAME	PIN NUMBER	SIGNAL NAME
A1	GND	B12	GND
A4	VBUS	B9	VBUS
A5	CC1	B8	SBU2
A6	Dp1	B7	Dn2
A7	Dn1	B6	Dp2
A8	SBU1	B5	CC2
A9	VBUS	B4	VBUS
A12	GND	B1	GND

P/N	(L)	COLOR	额定电流
HC-TYPE-C-16P-FLS7.2-5A-11	14.00mm	黑色	5A

Ordering Information

HC-TYPE-C - 16P - * * * - *A - F* - * - 11

Pin	Type	Current	Foot	Colour
4P	T=Top Mount (板上)	5A	长度	默认:Black
6P	DS=DF+SMT (表面贴)	5A	长度	White
9P	M=Mid Mount (中)	5A	长度	Blue
12P	CH=Center Height (中)	10A	长度	Green
16P	V=Vertical SMT (垂直贴)	5A	长度	Orange
24P	DF=DF (中)	5A	长度	Purple
	CP=Clip (夹)			Yellow
	FL=Flag (插)			
	FLS=Flag SMT (表面贴)			

② Moding	1	C7025 T=0.15mm Au 1u" SUS301 T=0.15mm; LCP黑色 H=7.2 半结构
① 外壳	1	SUS304 T=0.30mm Ni 50u~Min
NO. NAME	QT* Y	MATERIAL

GENERAL TOLERANCE		制图	
DIM	TOL	DRAWING	CHECK
X.X	±0.30	审核	
X.XX	±0.20	批准	
X.XXX	±0.10	比例	
Angle	±3.0°	投影	

深圳市华灿天禄电子有限公司
ShenzhenhuacantianluELECTRONICS CO.,LTD

产品名称 TITLE	TYPE CF 16P 侧面贴片 CH7.2mm L14.0mm 无弹无柱	版本 REV.	A
产品料号 PART NO.	HC-TYPE-C-16P-FLS7.2-5A-11	单位 UNITS	mm
材料 MATERIAL		页次 SHEET	1/2

序号 No.	变更内容 MODIFY CONTENT	日期 MODIFY DATE
1	初版发行	

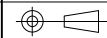

pcs/box	boxs/Carton	Pcs/Box
400	8	3200

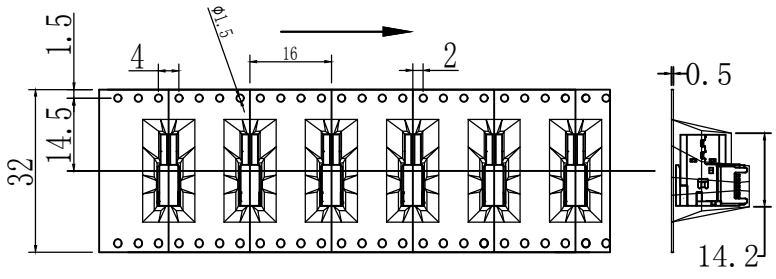
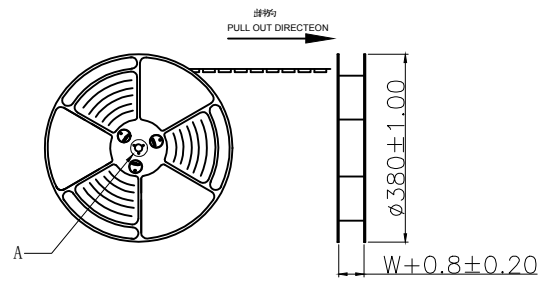

NOTES

1. 帶子引導長度
LEAD TAPE LENGTH
出料方向
PULL OUT DIRECTION

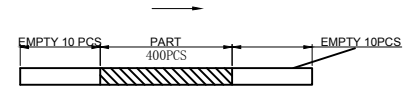

2. 上帶 剝力力為: $0.1 \sim 1.3N(10.2gf \sim 130gf)$
PEELING OFF FORCE OF TOP TAPE: $0.1 \sim 1.3N(10.2gf \sim 130gf)$
出貨'運輸過程中一定注意:
THIS REQUIREMENT SHOULD BE APPLIED AT SHIPMENT:
卷帶在運輸過程中不能散開
PEELING OFF SHOULD NOT BE ALLOWED DURING TRANSPORTATION

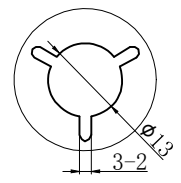
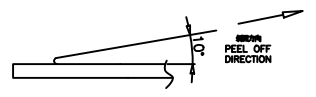

DETAIL: A
10:1

Location of label sticking (label)
at small positioning hole of the carrier tape side.
標籤黏貼處 (朝捲裝包材的小定位孔一側)

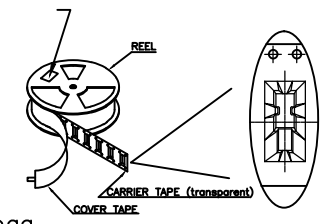
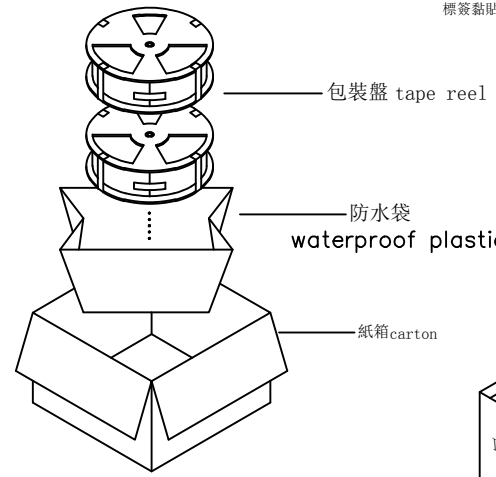

包裝盤 tape reel

防水袋
waterproof plastic bag

紙箱 carton

外箱标签

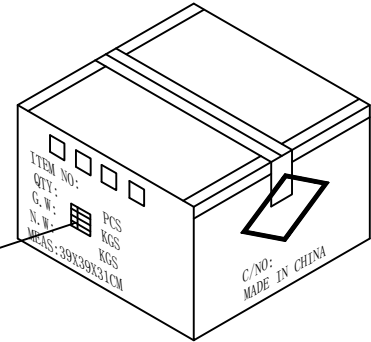

NOTE:

1. 每捲包裝數量及每箱裝箱數量如左下表格。
Packing q'ty of each reel & carton as below table shown.
2. 將裝滿產品的卷盤放入紙箱並以膠帶封口
Put reels in the carton and use adhesive tape to seal up.

			GENREL TOLERANCE		制 图 DRAWING		深圳市华灿天禄电子有限公司 ShenzhenhuacantianluELECTRONICS CO.,LTD			
			DIM	TOL	审 核 CHECK		产品名称 TITLE		版本 REV.	A
			X.X	± 0.30	批 准 APPROVAL		TYPE CF 16P 侧面贴片 CH7.2mm L14.0mm 无弹无柱-包装图			
			X.XX	± 0.20	比 例 SCALE		产品料号 PART NO.		单 位 UNITS	mm
			X.XXX	± 0.10	投 影 Projection		HC-TYPE-C-16P-FLS7.2-5A-11		页 次 SHEET	2/2
序号 No.	变更内容 MODIFY CONTENT	日期 MODIFY DATE	Angle $\pm 3.0^\circ$		材料 MATERIAL					

X-ON Electronics

Largest Supplier of Electrical and Electronic Components

Click to view similar products for [USB Connectors](#) category:

Click to view products by [HCTL](#) manufacturer:

Other Similar products are found below :

[950](#) [A-USB A-LP-SMT-C](#) [A-USB B-TOP-C](#) [MUSBD11135](#) [17-200721](#) [217450-1](#) [KMBVX-TH-5S-B30](#) [KUSBX-AS2N-W](#) [KUSBX-SMT2AP1S-W30](#) [935](#) [957](#) [30-498-6](#) [SK-60A-2](#) [1734082-1](#) [30-470](#) [30-489](#) [30-541](#) [MAB 5 S](#) [A-USB A-2P-C](#) [MIKROE-1451](#)
[USBFTVSCCG](#) [1-1734084-2](#) [MUSBA81130](#) [NK-27-32SL](#) [NK-L8-22C-5/8](#) [10135326-001LF](#) [4198](#) [690-024-633-031](#) [UB-20PMFP-LC7001](#)
[17-200011](#) [UB-20AFMM-LL7A01](#) [CAP-WCCMLPB1](#) [CAP-WCCMLPC1](#) [2274475-3](#) [914-614A2025S10200](#) [USB3FTV7SAGF059](#)
[USB3FTV2SAZNF459](#) [USB3FTV7SAZNF459](#) [HYCW153-USBD05-500B](#) [HYCW148-USBD05-117B](#) [HYCW149-USBD05-740B](#)
[HYCW214-USBA04-113B](#) [HYCW213-USBA04-113B](#) [KMMX-BSMT35S-1-B30TR](#) [2345986-1](#) [10082141-N340LF](#) [10117836-011LF](#)
[GSB3C3133DSYHR](#) [GT-USB-2014-CWG1](#) [GT-USB-7010ANS](#)