

SPECIFICATION:

1. CURRENT RATING: 5A MAX
2. VOLTAGE: 100 VAC
3. TEMPERATURE RANGE: -30 °C ~ 85 °C
4. CONTACT RESISTANCE: 40 MILLIONHM MAX
5. INSULATION RESISTANCE: 100 MEGOHMS MIN.
6. DIELECTRIC WITHSTAND VOLTAGE, AC 100V FOR 1 MINUTE.
7. INSERTION FORCE : 6N~20N
8. UNMATING FORCE: 8N~20N
9. DURABILITY: 10,000 CYCLES

USB TYPE-C PIN ASSIGNMENTS

PIN	SIGNAL NAME	PIN	SIGNAL NAME
A1	GND	B12	GND
A4	VBUS	B9	VBUS
A5	CC1	B8	SBU2
A6	DP1	B7	DN2
A7	DN1	B6	DP2
A8	SBU1	B5	CC2
A9	VBUS	B4	VBUS
A12	GND	B1	GND

P/N	(L)	COLOER	额定电流
HC-TYPE C-16P-MM0.54-5A-01	6.50mm	黑色	5A

Ordering Information

HC-TYPE C - 16P - \* \* \* - \*A - F\* - \* - 01

Pin: Pin  
 O/P: O/P  
 O/P: O/P  
 12P: 12P  
 16P: 16P  
 24P: 24P  
 Type: Type  
 T=Top Mount (板上)  
 DS=DP+SMT (插后贴)  
 M=Mid Mount (中贴)  
 C=Center Mount (中贴)  
 V=Vertical SMT (直立式)  
 DP=DP (插后)  
 CP=CP (插后)  
 FL=Flg (插后)  
 G=Green (绿色)  
 Y=Yellow (黄色)  
 Current Rated: 5A, 10A  
 Foot Length: 6.50mm (脚长)  
 Colour: Black, White, Blue, Green, Orange, Purple, Yellow

			GENREL TOLERANCE	制图 DRAWING				
			DIM TOL	审核 CHECK				
			X.X ±0.30	批准 APPROVAL	产品名称 TITLE	TYPE CF 16P 沉板0.54 L6.50mm 无柱无弹	版本 REV.	A
			X.XX ±0.20	比例 SCALE	产品料号 PART NO.	HC-TYPE-C-16P-MM0.54-5A-01	单位 UNITS	mm
			X.XXX ±0.10	投影 Projection	材料 MATERIAL		页次 SHEET	1/2
序号 No.	变更内容 MODIFY CONTENT	日期 MODIFY DATE	Angle ±3.0°					

深圳市华灿天禄电子有限公司  
 ShenzhenhuacantianluELECTRONICS CO.,LTD

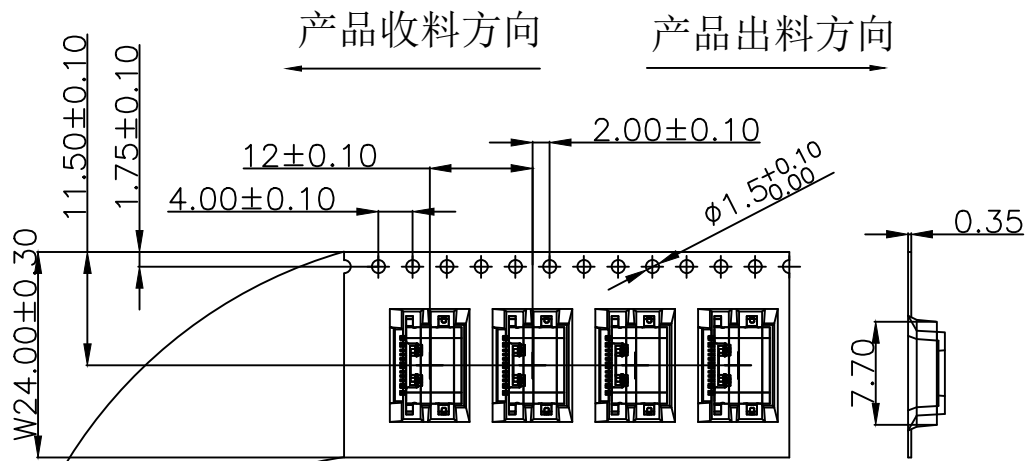

NOTE:  
 1. QUANTITY/REEL: 1500 PCS  
 数量/卷: 1500 PCS  
 QUANTITY/INNER CARTON: 1500 X 10 = 15000 PCS  
 数量/箱: 1500 X 10 = 15000 PCS  
 2. FREE 18 CAVE IN THE FRONT CARRIER AND FREE 18 CAVE IN THE END CARRIER.  
 包装带内圈空18格, 外圈空18格.

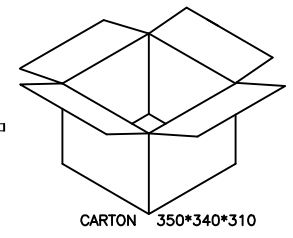
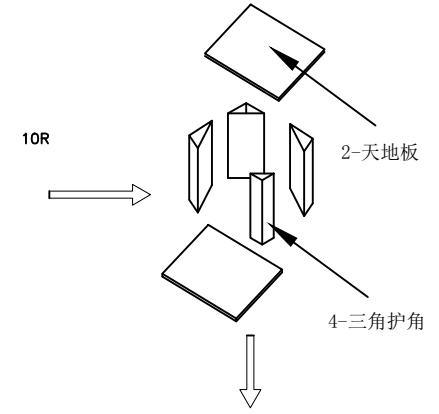
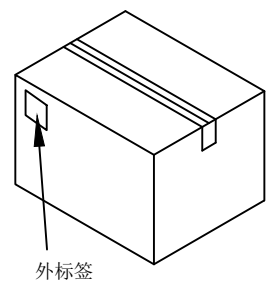
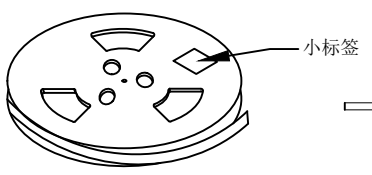
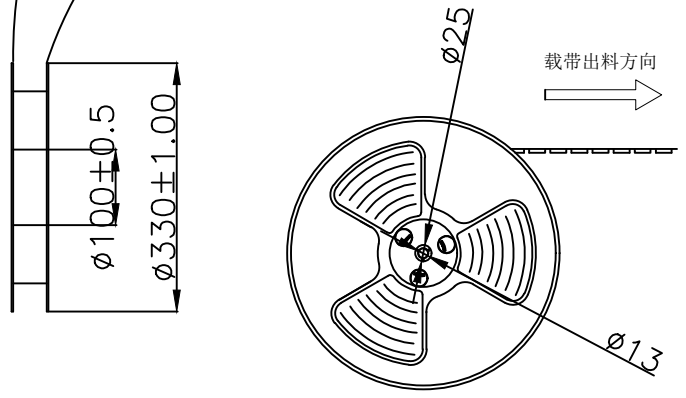
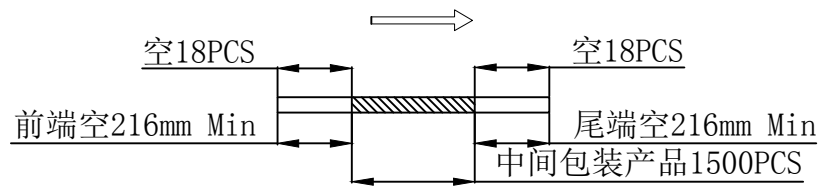

pcs/box	boxs/Carton	Pcs/Box
1500	10	15000

			GENERAL TOLERANCE	制图 DRAWING	深圳市华灿天禄电子有限公司 ShenzhenhuacantianluELECTRONICS CO., LTD			
			DIM TOL	审核 CHECK	产品名称 TITLE	TYPE CF 16P 沉板0.54 L6.50mm 无柱无弹-包装图	版本 REV.	A
			X.X ±0.30	批准 APPROVAL	产品料号 PART NO.	HC-TYPE C-16P-MMO.54-5A-01	单位 UNITS	mm
			X.XX ±0.20	比例 SCALE	材料 MATERIAL		页次 SHEET	2/2
			X.XXX ±0.10	投影 Projection				
序号 No.	变更内容 MODIFY CONTENT	日期 MODIFY DATE	Angle ±3.0°					

## X-ON Electronics

Largest Supplier of Electrical and Electronic Components

*Click to view similar products for [USB Connectors](#) category:*

*Click to view products by [HCTL](#) manufacturer:*

Other Similar products are found below :

[950](#) [A-USB A-LP-SMT-C](#) [A-USB B-TOP-C](#) [MUSBD11135](#) [17-200721](#) [217450-1](#) [KMBVX-TH-5S-B30](#) [KUSBX-AS2N-W](#) [KUSBX-SMT2AP1S-W30](#) [935](#) [957](#) [30-498-6](#) [SK-60A-2](#) [1734082-1](#) [30-470](#) [30-489](#) [30-541](#) [MAB 5 S](#) [A-USB A-2P-C](#) [MIKROE-1451](#)  
[USBFTVSCCG](#) [1-1734084-2](#) [MUSBA81130](#) [NK-27-32SL](#) [NK-L8-22C-5/8](#) [10135326-001LF](#) [4198](#) [690-024-633-031](#) [UB-20PMFP-LC7001](#)  
[17-200011](#) [UB-20AFMM-LL7A01](#) [CAP-WCCMLPB1](#) [CAP-WCCMLPC1](#) [2274475-3](#) [914-614A2025S10200](#) [USB3FTV7SAGF059](#)  
[USB3FTV2SAZNF459](#) [USB3FTV7SAZNF459](#) [HYCW153-USBD05-500B](#) [HYCW148-USBD05-117B](#) [HYCW149-USBD05-740B](#)  
[HYCW214-USBA04-113B](#) [HYCW213-USBA04-113B](#) [KMMX-BSMT35S-1-B30TR](#) [2345986-1](#) [10082141-N340LF](#) [10117836-011LF](#)  
[GSB3C3133DSYHR](#) [GT-USB-2014-CWG1](#) [GT-USB-7010ANS](#)