

SPECIFICATIONS

- 1、Current Rating: 10A AC, DC
- 2、Voltage Rating: 150V AC, DC
- 3、Temperatuer Range: -25°C~ +85°C
- 4、Contact Resistance: 20mΩ Max
- 5、Insulation Resistance: 1000mΩ Min
- 6、Withstanding Voltang: 1500V AC/minute
- 7、Material: Wafer Nylon66 UL94-V0(2)  
PIN Brass Tin-plated

Circuit	Part NO.	Dimensions mm	
		A	B
1	HC-XL-2x1A-X-05	---	8.15
2	HC-XL-2x2A-X-05	5.00	13.15
3	HC-XL-2x3A-X-05	10.00	18.15
4	HC-XL-2x4A-X-05	15.00	23.15
5	HC-XL-2x5A-X-05	20.00	28.15
6	HC-XL-2x6A-X-05	25.00	33.15
7	HC-XL-2x7A-X-05	30.00	38.15
8	HC-XL-2x8A-X-05	35.00	43.15
9	HC-XL-2x9A-X-05	40.00	48.15
10	HC-XL-2x10A-X-05	45.00	53.15

Ordering Information

HC-XL - N \* - \* - 05

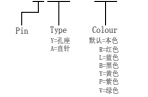

			GENREL TOLERANCE		制图 DRAWING		深圳市华灿天禄电子有限公司 ShenzhenhuacantianluELECTRONICS CO.,LTD			
			DIM	TOL	审核 CHECK					
			X.X	±0.30	批准 APPROVAL		产品名称 TITLE	XL (5.00) 双排 直针	版本 REV.	A
			X.XX	±0.20	比例 SCALE		产品料号 PART NO.	HC-XL-2xNA-X-05	单位 UNITS	mm
			X.XXX	±0.10	投影 Projection		材料 MATERIAL		页次 SHEET	1/1
序号 No.	变更内容 MODIFY CONTENT	日期 MODIFY DATE	Angle	±3.0°						

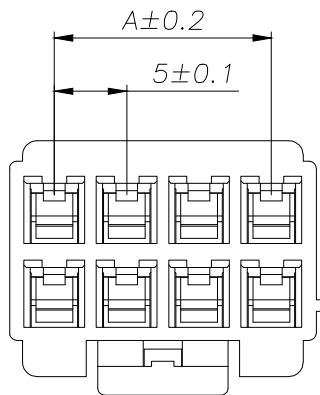
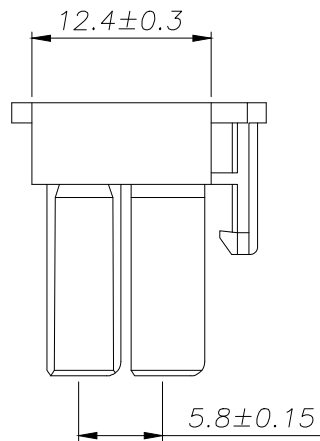
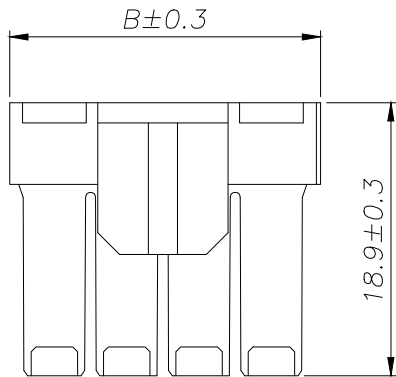
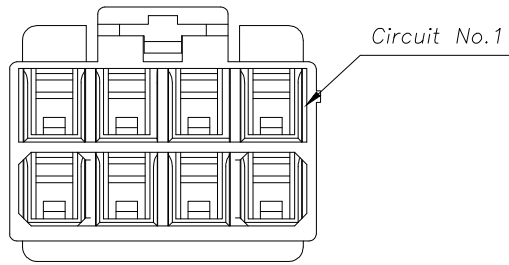

**SPECIFICATIONS**

- 1、Current Rating: 10A AC, DC
- 2、Voltage Rating: 150V AC, DC
- 3、Temperatuer Range: -25°C~ +85°C
- 4、Contact Resistance: 20mΩ Max
- 5、Insulation Resistance: 1000mΩ Min
- 6、Withstanding Voltang: 1500V AC/minute
- 7、Material: Housing Nylon66 UL94-V0(2)

Circuit	Part NO.	Dimensions mm	
		A	B
1	HC-XL-2x1Y-X-05	---	11.20
2	HC-XL-2x2Y-X-05	5.00	11.20
3	HC-XL-2x3Y-X-05	10.00	16.20
4	HC-XL-2x4Y-X-05	15.00	21.20
5	HC-XL-2x5Y-X-05	20.00	26.20
6	HC-XL-2x6Y-X-05	25.00	31.20
7	HC-XL-2x7Y-X-05	30.00	36.20
8	HC-XL-2x8Y-X-05	35.00	41.20
9	HC-XL-2x9Y-X-05	40.00	46.20
10	HC-XL-2x10Y-X-05	45.00	51.20

**Ordering Information**

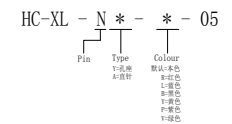

			GENERAL TOLERANCE	制图 DRAWING	深圳市华灿天禄电子有限公司 ShenzhenhuacantianluELECTRONICS CO.,LTD			
			DIM TOL	审核 CHECK	产品名称 TITLE	XL (5.00) 双排 孔座	版本 REV.	A
			X. X ±0.30	批准 APPROVAL	产品料号 PART NO.	HC-XL-2xNY-X-05	单位 UNITS	mm
1	初版发行		X. XX ±0.20	比例 SCALE			页次 SHEET	1/1
序号 No.	变更内容 MODIFY CONTENT	日期 MODIFY DATE	X. XXX ±0.10	投影 Projection	材料 MATERIAL			
			Angle ±3.0°					

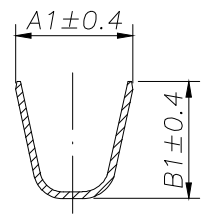
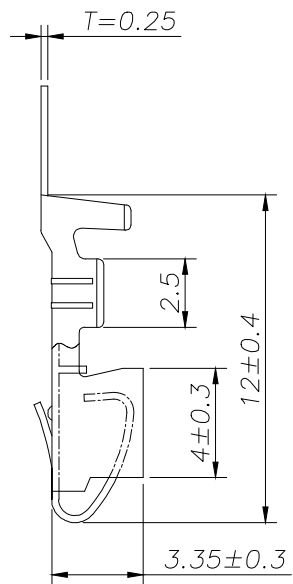
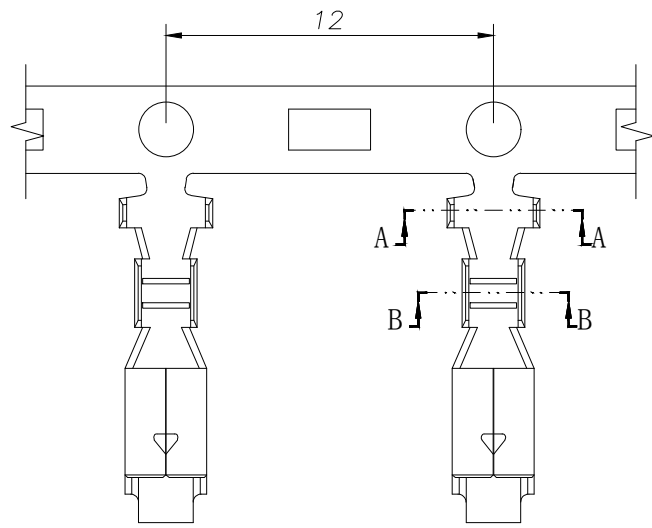

SECTION A-A

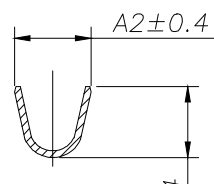

SECTION B-B

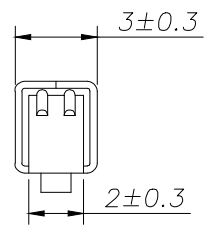

C 向

SPECIFICATIONS

- 1、 Current Rating: 10A AC, DC
- 2、 Voltage Rating: 150V AC, DC
- 3、 Temperatuer Range: -25℃~ +85℃
- 4、 Contact Resistance: 20mΩ Max
- 5、 Insulation Resistance: 1000mΩ Min
- 6、 Withstanding Voltang: 1500V AC/minute
- 7、 Material: Phosphoric brass Tin-plated
- 8、 Applicable Wire Sizes:AWG #16~26#

TYPE	Dimension mm				适用线规 AWG#
	A1	B1	A2	B2	
HC-XL-T-05	4.5	4.0	3.1	2.6	20-16
HC-XL-T-D-05	3.3	3.3	2.2	1.9	26-20

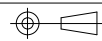
			GENREL TOLERANCE		制图 DRAWING		 <b>深圳市华灿天禄电子有限公司</b> ShenzhenhuacantianluELECTRONICS CO.,LTD			
			DIM	TOL	审核 CHECK					
			X.X	±0.30	批准 APPROVAL		产品名称 TITLE	XL (5.00) 端子	版本 REV.	A
1			初版发行		比例 SCALE		产品料号 PART NO.	HC-XL-T-05	单位 UNITS	mm
序号 No.	变更内容 MODIFY CONTENT	日期 MODIFY DATE	Angle	±3.0°	投影 Projection		材料 MATERIAL		页次 SHEET	1/1

## X-ON Electronics

Largest Supplier of Electrical and Electronic Components

*Click to view similar products for [Terminals](#) category:*

*Click to view products by [HCTL](#) manufacturer:*

Other Similar products are found below :

[00-054007-01074-6](#) [00-054007-70206-1](#) [00-054007-70210-8](#) [00-054007-70217-7](#) [00-054007-70228-3](#) [00-054007-70256-6](#) [00-054007-70316-7](#) [0-0320562-0](#) [00-054007-49560-4](#) [00-054007-70209-2](#) [00-054007-70231-3](#) [00-054007-70241-2](#) [00-054007-70242-9](#) [00-054007-70246-7](#) [00-054007-70263-4](#) [00-054007-70288-7](#) [00-054007-70290-0](#) [00-054007-70300-6](#) [00-054007-70304-4](#) [01-2900-1-04412](#) [00581P0075](#) [600TS-10](#) [605601-1](#) [60617-1-C](#) [61314-6-C](#) [61810-3](#) [62149-1](#) [626-0194](#) [63-S](#) [M55155/079C01](#) [M55155/099B03](#) [M55155/109H01](#) [M55155/29-5S](#) [M55155/29XJ08](#) [M55155/30-6S](#) [M55155/30-9S](#) [M55155/30XI09](#) [M6-14RSX](#) [696683-1](#) [696861-1](#) [696999-1](#) [M86700006](#) [D18-110B-C](#) [D18-110B-M](#) [701-1936](#) [701-1955](#) [701-2003](#) [701-2007](#) [701-2013](#) [701-2018](#)