

SMD2016-4 Crystal Resonator

7D030000M01

1. Scope:

1.1 This specification applies to the RoHS compliance quartz crystal unit with a frequency of 30.000MHz which will be used in crystal oscillator applications.

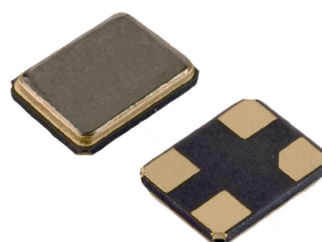

2. Construction:

2.1 Type of Quartz Resonator: SMD2016-4pads

3. Electrical Characteristics

3.1 Nominal Frequency(f):	30.000MHz
3.2 Load Capacitance(C_L):	12pF
3.3 Frequency Tolerance($\Delta f/f$):	± 10 ppm
3.4 Frequency Temperature Stability:	± 20 ppm
3.5 Resonance Resistance(ohm):	40 ohms Max
3.6 Osc mode:	Fundamental mode
3.7 Shunt Capacitance(C_0):	2pF Max
3.8 Drive Level(D_L):	100 μ W Max
3.9 Operating Temperature Range(T_{OPR}):	-20 to + 70°C
3.10 Storage Temperature Range(T_{STG}):	-55 to + 125°C
3.11 Insulation Resistance(IR):	> 500M ohms
3.12 Aging(Δf_A):	± 3 ppm/Year Max

Reliability Specification

	Item	Condition	Standard
1.	Drop characteristics	Free drop from 75cm height on a hard wooden board for 3 times. (Board is thickness more than 30 mm.)	Frequency change: $\leq \pm 5\text{ppm}$ Rr as specification
2.	Mechanical shock	Device are shocked to half sine wave (1000g) three mutually perpendicular axes each 3 times	Frequency change: $\leq \pm 5\text{ppm}$ Rr as specification
3.	Shake characteristics	Shake frequency 10~55Hz, cyc1~2 minutes, swing 1.5mm, direction x/y/z, all 30 minutes, test after 1 hours.	Frequency change: $\leq \pm 5\text{ppm}$ Rr as specification
4.	Humidity characteristics	$+40 \pm 2^\circ\text{C}$ & 90%~95% R.H. 250 hours	Frequency change: $\leq \pm 5\text{ppm}$ Rr as specification
5.	Low temperature characteristics	$-40 \pm 2^\circ\text{C}$, 250 hours, put in room temperature, test after 1 hours.	Frequency change: $\leq \pm 5\text{ppm}$ Rr as specification
6.	High temperature characteristics	$+85 \pm 2^\circ\text{C}$, 250 hours, put in room temperature, test after 1 hours.	Frequency change: $\leq \pm 5\text{ppm}$ Rr as specification
7.	Temperature cycling	$-30 \pm 3^\circ\text{C}/30 \pm 3 \text{ min} \sim +85 \pm 2^\circ\text{C}/30 \pm 3\text{min}$, 5 cycles	Frequency change: $\leq \pm 5\text{ppm}$ Rr as specification
8.	Refluence examination	 <p style="text-align: center;">1. Max 180sec 2. Max 10 sec 3. Max 80 sec 4. Max 90 sec</p>	Frequency change: $\leq \pm 5\text{ppm}$ Rr as specification

Package Outline Dimensions

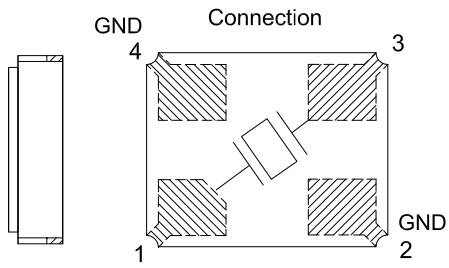

引脚	功能
#1	IN
#2	GND
#3	OUT
#4	GND

Suggested Pad Layout

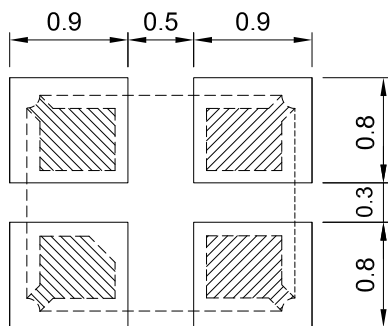

Packing Specificatio

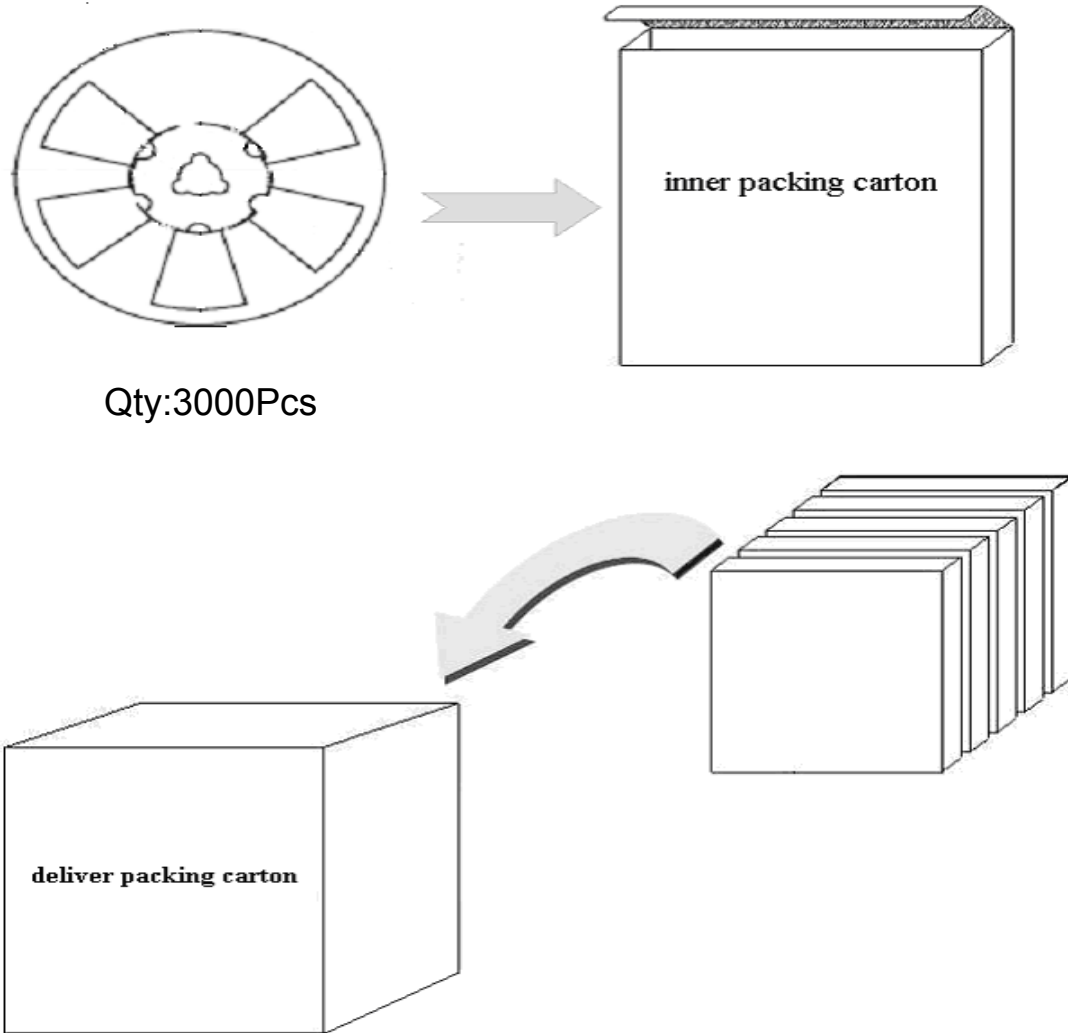

X-ON Electronics

Largest Supplier of Electrical and Electronic Components

Click to view similar products for [Resonators](#) category:

Click to view products by [HD-Crystal](#) manufacturer:

Other Similar products are found below :

[B39431R820H210](#) [CSAC2.00MGCM-TC](#) [ECS-HFR-40.00-B-TR](#) [CSTLS4M00G53Z-A0](#) [ZTB455E](#) [ECS-CR2-16.00-A-TR](#) [ECS-HFR-20.00-B-TR](#) [ECS-CR2-20.00-A-TR](#) [RO3164E-3](#) [ASR418S2-T](#) [CSTNE10M0G520000R0](#) [CSTLS8M00G53093-A0](#) [CSTNE12M0G52A000R0](#) [CSTLS18M4X54-A0](#) [CSTLS16M9X53Z-B0](#) [CSTLS24M0X51-A0](#) [CSTLS25M0X51-B0](#) [CSTLS18M0X51-B0](#) [CSTLS4M00G53093-A0](#) [CSTLS18M4X53-A0](#) [CSTNE16M0V510000R0](#) [CSTLS30M0X53-B0](#) [CSTLS33M8X53-B0](#) [CSTLS16M9X53-A0](#) [CSTLS6M40G56-B0](#) [CSTLS6M25G56-A0](#) [CSTNE14M7V510000R0](#) [CSTLS18M4X53-B0](#) [CSTLS33M0X51-B0](#) [CSTLS5M50G56-B0](#) [7B008000I01](#) [7D038400I01](#) [TAXM24M2ILDBET2T](#) [TAXM26M2IHDBET2T](#) [146-32.768-12.5-20-20/A](#) [3225-24.00-12-10-10/A](#) [7B009843M01](#) [CF4016M00009T8188042](#) [S32400001B0730D1JB](#) [X252016MLB4SI](#) [Q24FA20H00389](#) [CSTLS16M0X54-B0](#) [CSTLS4M19G56-B0](#) [9AC04194152080D2JB](#) [CST3.58MGW](#) [CSTCR4M91G55B-R0](#) [CSTLS3M68G56-B0](#) [S2100327072090](#) [FC-12M32.768KHZ9PF20PPM](#) [7Y032768NW2](#)