

| 修订 | 标记 | 修改摘要 | 签名 | 日期 |
|-----|------|----------------------|-----------|------------|
| REV | MARK | REVISION DESCRIPTION | SIGNATURE | DATE |
| NO | | NEW DWG | | 2016-03-12 |

| 孔位 | A | B | C | D |
|----|-------|-------|-------|-------|
| 4 | 1.50 | 2.60 | 6.35 | 7.65 |
| 5 | 2.00 | 3.10 | 6.85 | 8.15 |
| 6 | 2.50 | 3.60 | 7.35 | 8.65 |
| 7 | 3.00 | 4.10 | 7.85 | 9.15 |
| 8 | 3.50 | 4.60 | 8.35 | 9.65 |
| 9 | 4.00 | 5.10 | 8.85 | 10.15 |
| 10 | 4.50 | 5.60 | 9.35 | 10.65 |
| 11 | 5.00 | 6.10 | 9.85 | 11.15 |
| 12 | 5.50 | 6.60 | 10.35 | 11.65 |
| 13 | 6.00 | 7.10 | 10.85 | 12.15 |
| 14 | 6.50 | 7.60 | 11.35 | 12.65 |
| 15 | 7.00 | 8.10 | 11.85 | 13.15 |
| 16 | 7.50 | 8.60 | 12.35 | 13.65 |
| 17 | 8.00 | 9.10 | 12.85 | 14.15 |
| 18 | 8.50 | 9.60 | 13.35 | 14.65 |
| 19 | 9.00 | 10.10 | 13.85 | 15.15 |
| 20 | 9.50 | 10.60 | 14.35 | 15.65 |
| 21 | 10.00 | 11.10 | 14.85 | 16.15 |
| 22 | 10.50 | 11.60 | 15.35 | 16.65 |
| 23 | 11.00 | 12.10 | 15.85 | 17.15 |
| 24 | 11.50 | 12.60 | 16.35 | 17.65 |
| 25 | 12.00 | 13.10 | 16.85 | 18.15 |
| 26 | 12.50 | 13.60 | 17.35 | 18.65 |
| 27 | 13.00 | 14.10 | 17.85 | 19.15 |
| 28 | 13.50 | 14.60 | 18.35 | 19.65 |
| 29 | 14.00 | 15.10 | 18.85 | 20.15 |
| 30 | 14.50 | 15.60 | 19.35 | 20.65 |
| 31 | 15.00 | 16.10 | 19.85 | 21.15 |
| 32 | 15.50 | 16.60 | 20.35 | 21.65 |
| 33 | 16.00 | 17.10 | 20.85 | 22.15 |
| 34 | 16.50 | 17.60 | 21.35 | 22.65 |
| 35 | 17.00 | 18.10 | 21.85 | 23.15 |
| 36 | 17.50 | 18.60 | 22.35 | 23.65 |
| 37 | 18.00 | 19.10 | 22.85 | 24.15 |
| 38 | 18.50 | 19.60 | 23.35 | 24.65 |
| 39 | 19.00 | 20.10 | 23.85 | 25.15 |
| 40 | 19.50 | 20.60 | 24.35 | 25.65 |
| 41 | 20.00 | 21.10 | 24.85 | 26.15 |
| 42 | 20.50 | 21.60 | 25.35 | 26.65 |
| 43 | 21.00 | 22.10 | 25.85 | 27.15 |
| 44 | 21.50 | 22.60 | 26.35 | 27.65 |
| 45 | 22.00 | 23.10 | 26.85 | 28.15 |
| 46 | 22.50 | 23.60 | 27.35 | 28.65 |
| 47 | 23.00 | 24.10 | 27.85 | 29.15 |
| 48 | 23.50 | 24.60 | 28.35 | 29.65 |
| 49 | 24.00 | 25.10 | 28.85 | 30.15 |
| 50 | 24.50 | 25.60 | 29.35 | 30.65 |
| 51 | 25.00 | 26.10 | 29.85 | 31.15 |
| 52 | 25.50 | 26.60 | 30.35 | 31.65 |
| 53 | 26.00 | 27.10 | 30.85 | 32.15 |
| 54 | 26.50 | 27.60 | 31.35 | 32.65 |
| 55 | 27.00 | 28.10 | 31.85 | 33.15 |
| 56 | 27.50 | 28.60 | 32.35 | 33.65 |
| 57 | 28.00 | 29.10 | 32.85 | 34.15 |
| 58 | 28.50 | 29.60 | 33.35 | 34.65 |
| 59 | 29.00 | 30.10 | 33.85 | 35.15 |
| 60 | 29.50 | 30.60 | 34.35 | 35.65 |

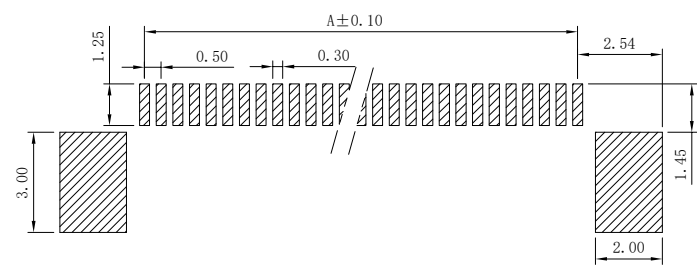

PCB Layout

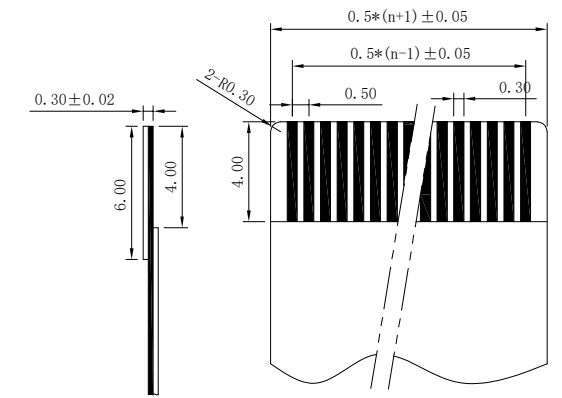
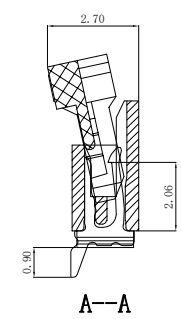
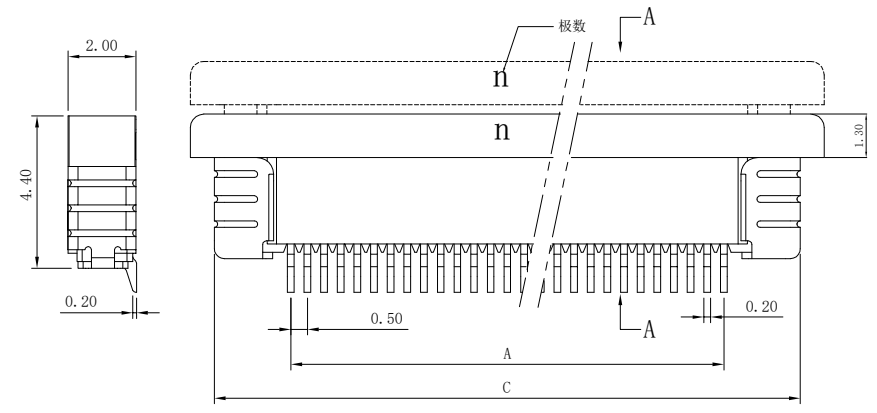
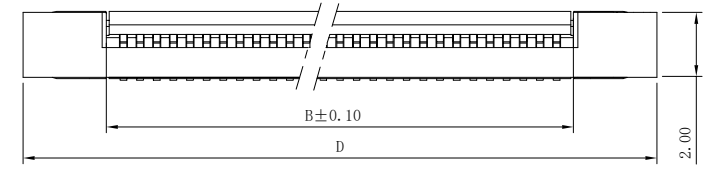
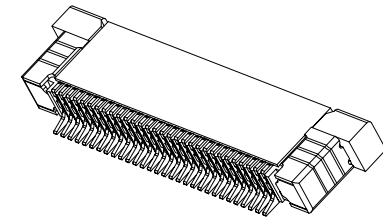

性能:
 额定电流: 0.4A
 额定电压: 50V
 耐电压: 200V
 接触电阻: ≤ 20mΩ
 绝缘电阻: 500MΩ
 工作温度: -20℃~+85℃

塑件(材质): LCP, UL94V-0
 锁扣(材质): LCP, UL94V-0
 插簧(材质): 磷青铜, 镀锡/镀金
 焊片(材质): 磷青铜, 镀锡/镀金



深圳市华德共创科技有限公司
 Shenzhen Huade co-create Technology Co.,LTD
 电话: 0755-23304126 传真: 0755-29940187

| -TOLERANCES- UNLESS OTHERWISE SPECIFIED 公差参数表 | | TITLE: 产品名称: 0.5mm FPC (A型)上接 | |
|---|------------|----------------------------------|--------------------------------|
| X.X ±0.30 | X.X* ±3° | APPD: 核准: 谢亮 | PART NO: 产品编号: 0.5K-AS-nPWB |
| X.XX ±0.20 | X.XX* ±2° | CHECK: 校对: 王建业 | DATE SCALE UNIT CODE NUMBER |
| X.XXX ±0.10 | X.XXX* ±1° | DRAW: 绘图: 黄艳兰 | 2016-03-12 1:1 mm A001 |

X-ON Electronics

Largest Supplier of Electrical and Electronic Components

Click to view similar products for [FFC & FPC Connectors](#) category:

Click to view products by [HDGC](#) manufacturer:

Other Similar products are found below :

[00-6200-227-022-800](#) [006205250500825+](#) [006205280500825+](#) [FPH-1602G](#) [086222026001800](#) [52610-0675](#) [62674-201121DLF](#) [52746-1671-TR250](#) [10051922-1610EHLF](#) [10051922-2810EHLF](#) [686322124422](#) [XF3M-2915-1B-R100](#) [AYF353125A](#) [AYF530665TA](#) [AYF534065TA](#) [20FLH-RSM1-TB](#) [PCA-7F-25-HL-3-G](#) [207356-1](#) [52807-0430](#) [FFC05011-10SBB114W5M](#) [502250-8027](#) [FH28K-40S-0.5SH](#) [200528-0260](#) [FH28K-10S-0.5SH](#) [501951-1250](#) [X05B20U43T](#) [0.5K-DX-30PWB](#) [DS1020-08-10VBT12](#) [THD0515-34CL-GF](#) [X05A10L28G](#) [ECC2841061EU](#) [20539-030E-01](#) [1.0K-DHQX-16PWB](#) [1.0K-DHQX-30PWB](#) [1775333-6](#) [10054365-202110ELF](#) [10054365-242110ELF](#) [10054365-282110ELF](#) [10064555-392220HLF](#) [59453-041110EBHLF](#) [59453-091110EDHLF](#) [62674-241141ALF](#) [62684-432100ALF](#) [62684-451100AHLF](#) [62684-5721N0ALF](#) [HFW11R-1STE1MTLF](#) [HFW12R-1STE9LF](#) [HFW14R-1STE9MTLF](#) [HFW18S-2STE9LF](#) [HFW20R-1STAE1HLF](#)