

A B C D E F

修订	标记	修改摘要	签名	日期
REV	MARK	REVISION DESCRIPTION	SIGNATURE	DATE
NO		NEW DWG		2016-03-12

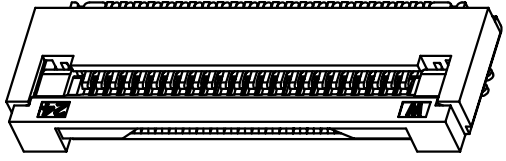

序号 (NO.)	品名 (Name)	材质 (Material)
①	0.5掀盖胶芯(H=2.0) 0.5 Pitch Easy-on Type Housing (H=2.0)	LCP UL94V-0 本色 Natural
②	0.5掀盖端子(H=2.0) 0.5 Pitch Easy-on Type Terminal (H=2.0)	磷青铜/表面镀锡 Phosphor Bronze/ Tin Plating
③	0.5掀盖后盖(H=2.0) 0.5 Pitch Easy-on Type Actuator (H=2.0)	LCP UL94V-0 黑色 Black
④	0.5掀盖焊片(H=2.0) 0.5 Pitch Easy-on Type Fitting Nail (H=2.0)	磷青铜/表面镀锡 Phosphor Bronze/ Tin Plating

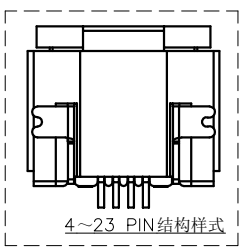
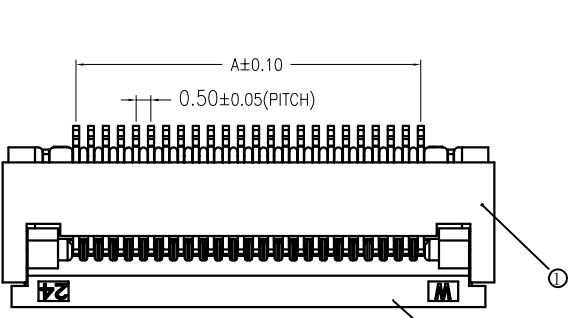
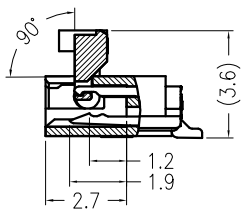
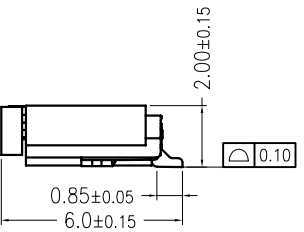
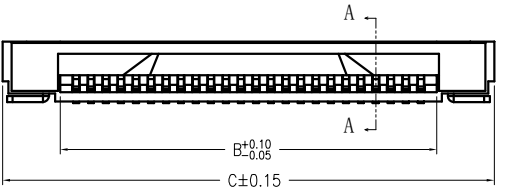

CKT	A			B			C		
	A	B	C	A	B	C	A	B	C
4	1.50	2.56	6.40	34	16.50	17.56	21.40		
5	2.00	3.06	6.90	35	17.00	18.06	21.90		
6	2.50	3.56	7.40	36	17.50	18.56	22.40		
7	3.00	4.06	7.90	37	18.00	19.06	22.90		
8	3.50	4.56	8.40	38	18.50	19.56	23.40		
9	4.00	5.06	8.90	39	19.00	20.06	23.90		
10	4.50	5.56	9.40	40	19.50	20.56	24.40		
11	5.00	6.06	9.90	41	20.00	21.06	24.90		
12	5.50	6.56	10.40	42	20.50	21.56	25.40		
13	6.00	7.06	10.90	43	21.00	22.06	25.90		
14	6.50	7.56	11.40	44	21.50	22.56	26.40		
15	7.00	8.06	11.90	45	22.00	23.06	26.90		
16	7.50	8.56	12.40	46	22.50	23.56	27.40		
17	8.00	9.06	12.90	47	23.00	24.06	27.90		
18	8.50	9.56	13.40	48	23.50	24.56	28.40		
19	9.00	10.06	13.90	49	24.00	25.06	28.90		
20	9.50	10.56	14.40	50	24.50	25.56	29.40		
21	10.00	11.06	14.90	51	25.00	26.06	29.90		
22	10.50	11.56	15.40	52	25.50	26.56	30.40		
23	11.00	12.06	15.90	53	26.00	27.06	30.90		
24	11.50	12.56	16.40	54	26.50	27.56	31.40		
25	12.00	13.06	16.90	55	27.00	28.06	31.90		
26	12.50	13.56	17.40	56	27.50	28.56	32.40		
27	13.00	14.06	17.90	57	28.00	29.06	32.90		
28	13.50	14.56	18.40	58	28.50	29.56	33.40		
29	14.00	15.06	18.90	59	29.00	30.06	33.90		
30	14.50	15.56	19.40	60	29.50	30.56	34.40		
31	15.00	16.06	19.90	61	30.00	31.06	34.90		
32	15.50	16.56	20.40	64	31.50	32.56	36.40		
33	16.00	17.06	20.90	65	32.00	33.06	36.90		

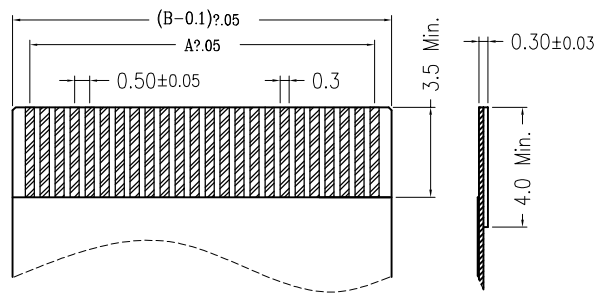

适用扁平线(Applicable Flat Cable)

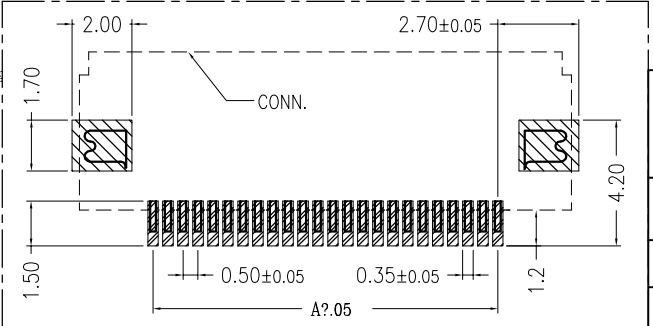
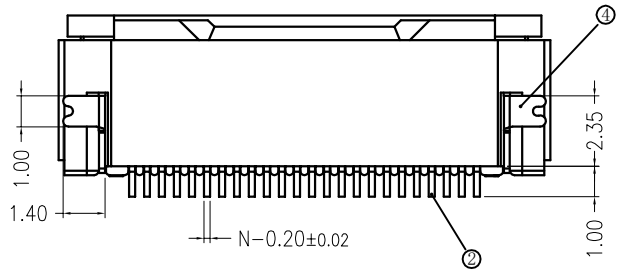



适用线路板(PCB LAYOUT)

技术指标(Technical Index):

1. 塑件表面应光洁、无毛边、无明显收缩、缺陷、裂纹等现象。(The surface of the plastic parts should be smooth, no rough edges, no obvious shrinkage, defects, cracks and other phenomena.)
2. 温度范围(Temperature range): -25° C~85° C.
3. 额定电压(Rated voltage): 50V, AC/DC(=等效).
4. 接触电阻(Contact resistance): ≤0.03Ω.
5. 绝缘电阻(Insulation resistance): ≥500MΩ.
6. 产品料号(Product material No.):



深圳市华德共创科技有限公司
Shenzhen Huade co-create Technology Co., LTD
电话: 0755-23304126 传真: 0755-29940187

-TOLERANCES- UNLESS OTHERWISE SPECIFIED 公差参数表		 	TITLE: 产品名称: 0.5间距2.0高掀盖式					
X.X	±0.30	X.X*	±3°	APPD: 核准:		PART NO: 产品编号: 0.5K-DHGX-nPWB		
X.XX	±0.20	X.XX*	±2°	CHECK: 校对: 王建业	DATE	SCALE	UNIT	CODE NUMBER
X.XXX	±0.10	X.XXX*	±1°	DRAW: 绘图: 黄艳兰	2016-03-12	1:1	mm	A001

X-ON Electronics

Largest Supplier of Electrical and Electronic Components

Click to view similar products for [FFC & FPC Connectors](#) category:

Click to view products by [HDGC](#) manufacturer:

Other Similar products are found below :

[00-6200-227-022-800](#) [006205250500825+](#) [006205280500825+](#) [FPH-1602G](#) [52610-1275](#) [XF3M\(1\)-1415-1B-R100](#) [501864-3091-TR225](#)
[086222026001800](#) [52610-0675](#) [62674-201121DLF](#) [62684-36210E9ALF](#) [52746-1671-TR250](#) [10051922-2810EHLF](#) [686322124422](#) [XF3M-](#)
[2915-1B-R100](#) [AYF353125A](#) [AYF530665TA](#) [AYF534065TA](#) [20FLH-RSM1-TB](#) [AYF351525](#) [086212040340800+](#) [AYF530365TA](#) [67000-](#)
[004LF](#) [006207341915000+](#) [207356-1](#) [67000-003LF](#) [SFW12R-5STE9LF](#) [SFW18R-1STAE9LF](#) [SFW4R-5STE9LF](#) [52807-0430](#)
[046283021002868+](#) [502250-8027](#) [104267-9617](#) [66987-011LF](#) [HFW8S-2STAE1HLF](#) [67000-008LF](#) [HFW22R-2STE1H1LF](#) [0781271110](#)
[0781272410](#) [0781272810](#) [5019511030](#) [FH28K-40S-0.5SH](#) [200528-0260](#) [5039084120](#) [503908-5120](#) [SFW20R-1STGE5LF](#) [FH12-18S-0.5SH](#)
[686116183522](#) [686114183522](#) [502078-5362](#)