

A

B

C

D

E

F

修 订	标 记	修 改 描 要	签 名	日 期
REV NO	MARK	REVISION DESCRIPTION	SIGNATURE	DATE
		NEW DWG		2016-03-12

性能:

额定电流: 0.5A

额定电压: 50V

耐压: 500V

接触电阻:  $\leq 20m\Omega$ 绝缘电阻: 800M $\Omega$ 

工作温度: -20℃~+85℃

塑件(材质): LCP, UL94V-0

锁扣(材质): LCP, UL94V-0

插簧(材质): 磷青铜, 镀锡/镀金

孔位	A	B	C	D
2	1	3.15	7.2	9.1
3	2	4.15	8.2	10.1
4	3	5.15	9.2	11.1
5	4	6.15	10.2	12.1
6	5	7.15	11.2	13.1
7	6	8.15	12.2	14.1
8	7	9.15	13.2	15.1
9	8	10.15	14.2	16.1
10	9	11.15	15.2	17.1
11	10	12.15	16.2	18.1
12	11	13.15	17.2	19.1
13	12	14.15	18.2	20.1
14	13	15.15	19.2	21.1
15	14	16.15	20.2	22.1
16	15	17.15	21.2	23.1
17	16	18.15	22.2	24.1
18	17	19.15	23.2	25.1
19	18	20.15	24.2	26.1
20	19	21.15	25.2	27.1
21	20	22.15	26.2	28.1
22	21	23.15	27.2	29.1
23	22	24.15	28.2	30.1
24	23	25.15	29.2	31.1
25	24	26.15	30.2	32.1
26	25	27.15	31.2	33.1
27	26	28.15	32.2	34.1
28	27	29.15	33.2	35.1
29	28	30.15	34.2	36.1
30	29	31.15	35.2	37.1
31	30	32.15	36.2	38.1
32	31	33.15	37.2	39.1
33	32	34.15	38.2	40.1
34	33	35.15	39.2	41.1
35	34	36.15	40.2	42.1

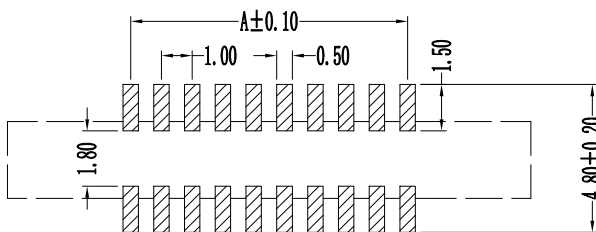
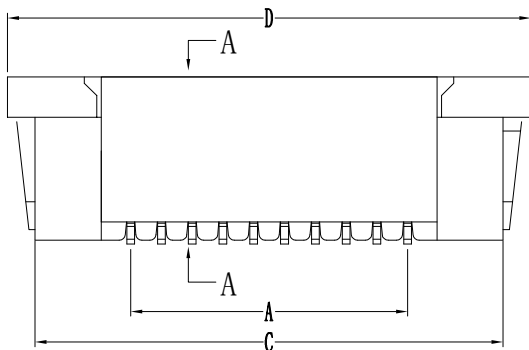
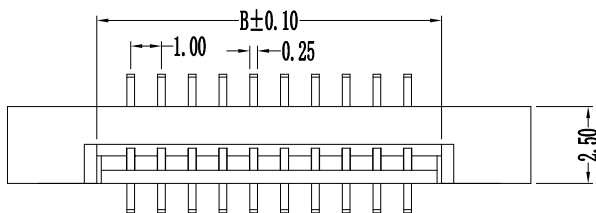

PCB Layout

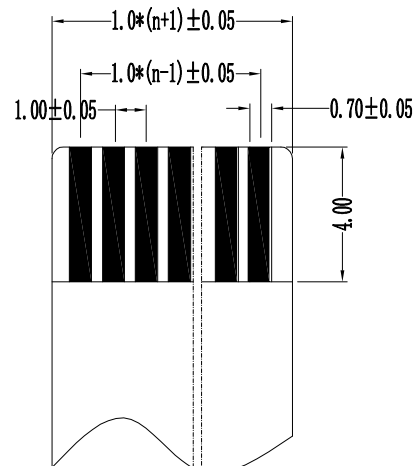
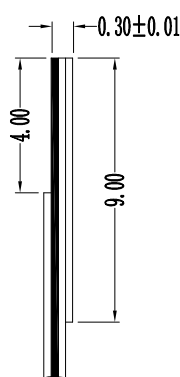
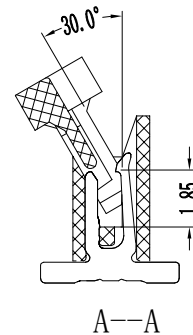
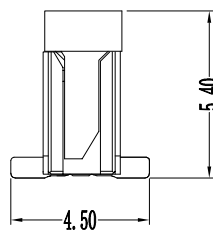

适用扁平电缆



深圳市华德共创科技有限公司

Shenzhen Huade co-create Technology Co., LTD

电话: 0755-23304126 传真: 0755-29940187

-TOLERANCES- UNLESS OTHERWISE SPECIFIED 公差参数表		 		TITLE: 产品名称: 1.0mm FPC (G型) 立贴式(无焊片)				
X.X	±0.30	X.X*	±3°	APPD: 核准:	PART NO: 产品编号: 1.0K-GT-nPB			
X.XX	±0.20	X.XX*	±2°	CHECK: 校对: 王建业	DATE	SCALE	UNIT	CODE NUMBER
X.XXX	±0.10	X.XXX*	±1°	DRAW: 绘图: 黄艳兰	2016-03-12	1:1	mm	A001

## X-ON Electronics

Largest Supplier of Electrical and Electronic Components

*Click to view similar products for [FFC & FPC Connectors](#) category:*

*Click to view products by [HDGC](#) manufacturer:*

Other Similar products are found below :

[00-6200-227-022-800](#) [006205250500825+](#) [006205280500825+](#) [FPH-1602G](#) [FPH-2022G](#) [52610-1275](#) [501864-3091-TR225](#)  
[086222026001800](#) [52610-0675](#) [62674-201121DLF](#) [62684-36210E9ALF](#) [52746-1671-TR250](#) [10051922-2810EHLF](#) [686322124422](#) [XF3M-](#)  
[2915-1B-R100](#) [AYF353125A](#) [AYF530665TA](#) [AYF534065TA](#) [AYF351525](#) [086212040340800+](#) [AYF530365TA](#) [67000-004LF](#)  
[006207341915000+](#) [207356-1](#) [67000-003LF](#) [HFW14R-2STE9LF](#) [SFW12R-5STE9LF](#) [SFW18R-1STAE9LF](#) [SFW4R-5STE9LF](#) [52807-0430](#)  
[046283021002868+](#) [502250-8027](#) [104267-9617](#) [66987-011LF](#) [HFW8S-2STAE1HLF](#) [67000-008LF](#) [HFW22R-2STE1H1LF](#) [0781271110](#)  
[5019511030](#) [200528-0260](#) [5039084120](#) [503908-5120](#) [SFW20R-1STGE5LF](#) [FH12-18S-0.5SH](#) [686116183522](#) [FH64MA-11S-0.25SHW](#)  
[686114183522](#) [502078-5362](#) [FH52K-68S-0.5SH](#) [FH26W-23S-0.3SHW\(60\)](#)