

A

B

C

D

E

F

| | | | | |
|-----------|--------|-------------------------|-----------|------------|
| 修 订 | 标 记 | 修 改 描 要 | 签 名 | 日 期 |
| REV NO | MARK | REVISION DESCRIPTION | SIGNATURE | DATE |
| | | NEW DWG | | 2016-03-12 |

性能:

额定电流: 0.5A

额定电压: 50V

耐压: 500V

接触电阻: $\leq 20m\Omega$ 绝缘电阻: 800M Ω

工作温度: -20℃~+85℃

塑件(材质): LCP, UL94V-0

锁扣(材质): LCP, UL94V-0

插簧(材质): 磷青铜, 镀锡/镀金

| 孔位 | A | B | C | D |
|----|----|-------|------|------|
| 2 | 1 | 3.15 | 7.2 | 9.1 |
| 3 | 2 | 4.15 | 8.2 | 10.1 |
| 4 | 3 | 5.15 | 9.2 | 11.1 |
| 5 | 4 | 6.15 | 10.2 | 12.1 |
| 6 | 5 | 7.15 | 11.2 | 13.1 |
| 7 | 6 | 8.15 | 12.2 | 14.1 |
| 8 | 7 | 9.15 | 13.2 | 15.1 |
| 9 | 8 | 10.15 | 14.2 | 16.1 |
| 10 | 9 | 11.15 | 15.2 | 17.1 |
| 11 | 10 | 12.15 | 16.2 | 18.1 |
| 12 | 11 | 13.15 | 17.2 | 19.1 |
| 13 | 12 | 14.15 | 18.2 | 20.1 |
| 14 | 13 | 15.15 | 19.2 | 21.1 |
| 15 | 14 | 16.15 | 20.2 | 22.1 |
| 16 | 15 | 17.15 | 21.2 | 23.1 |
| 17 | 16 | 18.15 | 22.2 | 24.1 |
| 18 | 17 | 19.15 | 23.2 | 25.1 |
| 19 | 18 | 20.15 | 24.2 | 26.1 |
| 20 | 19 | 21.15 | 25.2 | 27.1 |
| 21 | 20 | 22.15 | 26.2 | 28.1 |
| 22 | 21 | 23.15 | 27.2 | 29.1 |
| 23 | 22 | 24.15 | 28.2 | 30.1 |
| 24 | 23 | 25.15 | 29.2 | 31.1 |
| 25 | 24 | 26.15 | 30.2 | 32.1 |
| 26 | 25 | 27.15 | 31.2 | 33.1 |
| 27 | 26 | 28.15 | 32.2 | 34.1 |
| 28 | 27 | 29.15 | 33.2 | 35.1 |
| 29 | 28 | 30.15 | 34.2 | 36.1 |
| 30 | 29 | 31.15 | 35.2 | 37.1 |
| 31 | 30 | 32.15 | 36.2 | 38.1 |
| 32 | 31 | 33.15 | 37.2 | 39.1 |
| 33 | 32 | 34.15 | 38.2 | 40.1 |
| 34 | 33 | 35.15 | 39.2 | 41.1 |
| 35 | 34 | 36.15 | 40.2 | 42.1 |

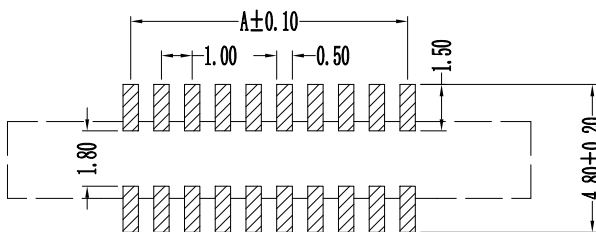
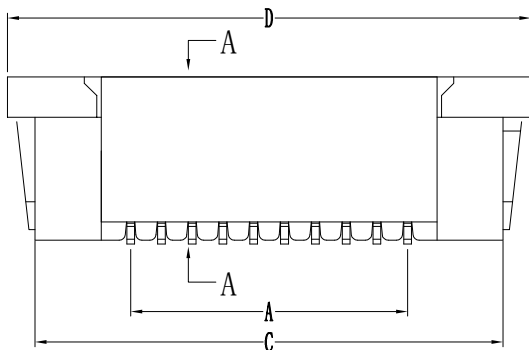
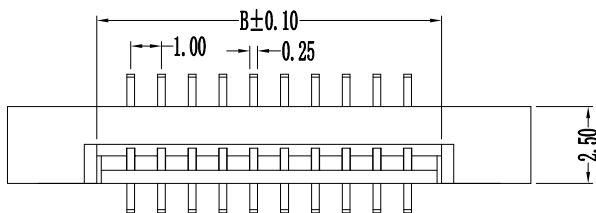

PCB Layout

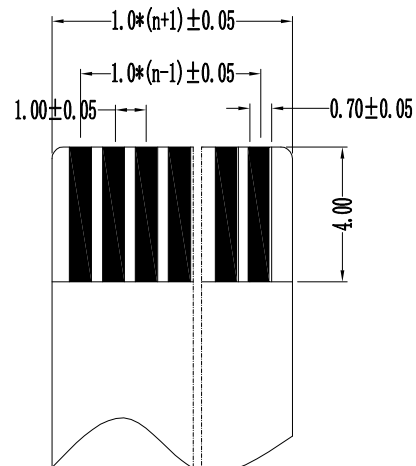
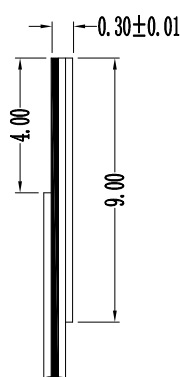
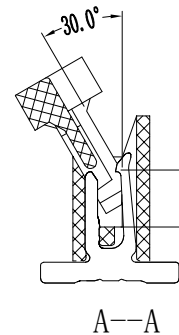
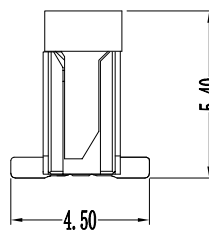

适用扁平电缆



深圳市华德共创科技有限公司

Shenzhen Huade co-create Technology Co., LTD

电话: 0755-23304126 传真: 0755-29940187

| -TOLERANCES- UNLESS OTHERWISE SPECIFIED 公差参数表 | | | | TITLE: 产品名称: 1.0mm FPC (G型) 立贴式(无焊片) | | | | |
|---|-------|--------|-----|---|-------------------------------|-------|------|-------------|
| X.X | ±0.30 | X.X* | ±3° | APPD: 核准: | PART NO: 产品编号: 1.0K-GT-nPB | | | |
| X.XX | ±0.20 | X.XX* | ±2° | CHECK: 校对: 王建业 | DATE | SCALE | UNIT | CODE NUMBER |
| X.XXX | ±0.10 | X.XXX* | ±1° | DRAW: 绘图: 黄艳兰 | 2016-03-12 | 1:1 | mm | A001 |

X-ON Electronics

Largest Supplier of Electrical and Electronic Components

Click to view similar products for [FFC & FPC Connectors](#) category:

Click to view products by [HDGC](#) manufacturer:

Other Similar products are found below :

[00-6200-227-022-800](#) [006205250500825+](#) [006205280500825+](#) [FPH-1602G](#) [086222026001800](#) [52610-0675](#) [62674-201121DLF](#) [52746-1671-TR250](#) [10051922-1610EHLF](#) [10051922-2810EHLF](#) [686322124422](#) [XF3M-2915-1B-R100](#) [AYF353125A](#) [AYF530665TA](#) [AYF534065TA](#) [20FLH-RSM1-TB](#) [207356-1](#) [SFW12R-5STE9LF](#) [SFW18R-1STAE9LF](#) [SFW4R-5STE9LF](#) [52807-0430](#) [046283021002868+](#) [FFC05011-10SBB114W5M](#) [502250-8027](#) [67000-008LF](#) [200528-0260](#) [FH28K-10S-0.5SH](#) [FH52K-6S-0.5SH](#) [0.5K-DX-30PWB](#) [DS1020-08-10VBT12](#) [THD0515-34CL-GF](#) [X05A10L28G](#) [ECC2841061EU](#) [1.0K-DHQX-16PWB](#) [1.0K-DHQX-30PWB](#) [1775333-6](#) [10054365-202110ELF](#) [10054365-242110ELF](#) [10054365-282110ELF](#) [10064555-392220HLF](#) [59453-041110EBHLF](#) [59453-091110EDHLF](#) [62674-241141ALF](#) [62684-432100ALF](#) [62684-451100AHLF](#) [62684-5721N0ALF](#) [HFW11R-1STE1MTLF](#) [HFW12R-1STE9LF](#) [HFW14R-1STE9MTLF](#) [HFW18S-2STE9LF](#)