

修订 REV NO	标记 MARK	修改摘要 REVISION DESCRIPTION	签名 SIGNATURE	日期 DATE
		NEW DWG		2016-03-12

性能:

额定电流: 1A
 额定电压: 100V
 耐电压: 500V
 接触电阻: $\leq 20m\Omega$
 绝缘电阻: 500M Ω
 工作温度: $-20^{\circ}C \sim +85^{\circ}C$

塑件(材质): LCP, UL94V-0
 插簧(材质): 磷青铜, 镀锡/镀金
 焊片(材质): 磷青铜, 镀锡/镀金

孔位	A	B	C
2	1.25	3.10	7.35
3	2.50	4.35	8.60
4	3.75	5.60	9.85
5	5.00	6.85	11.10
6	6.25	8.10	12.35
7	7.50	9.35	13.60
8	8.75	10.60	14.85
9	10.00	11.85	16.10
10	11.25	13.10	17.35
11	12.50	14.35	18.60
12	13.75	15.60	19.85
13	15.00	16.85	21.10
14	16.25	18.10	22.35
15	17.50	19.35	23.60
16	18.75	20.60	24.85
17	20.00	21.85	26.10
18	21.25	23.10	27.35
19	22.50	24.35	28.60
20	23.75	25.60	29.85

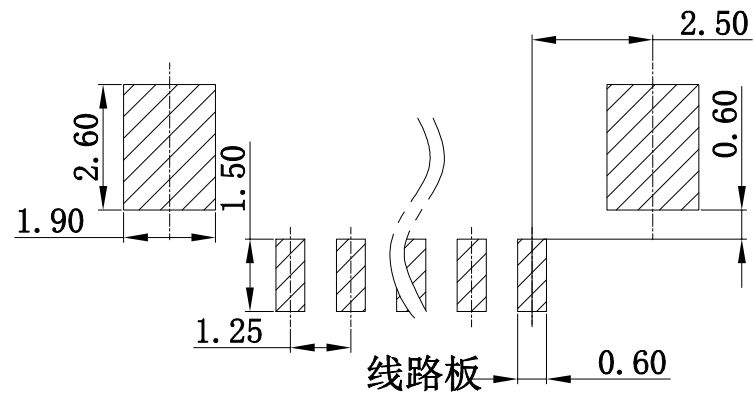
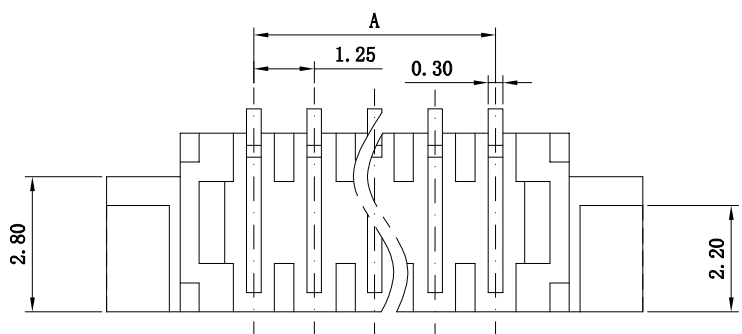
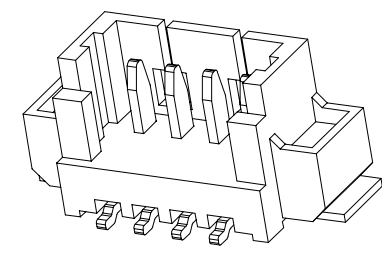
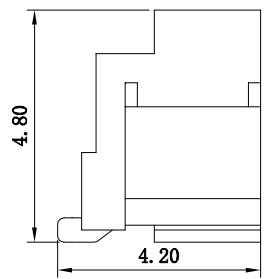
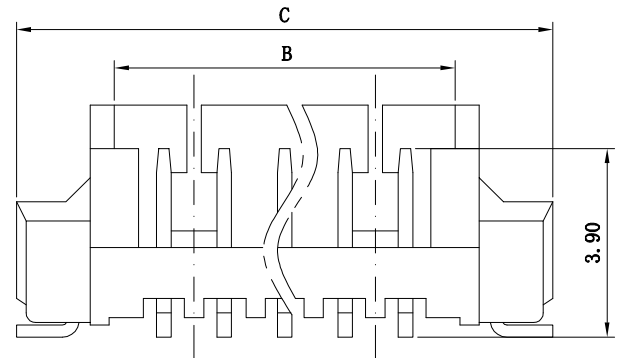

线路板
P.C.B Layout

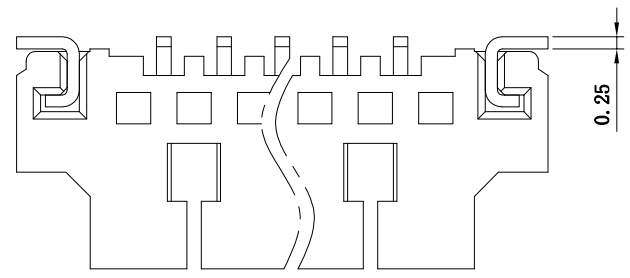



深圳市华德共创科技有限公司
 Shenzhen Huade co-create Technology Co., LTD
 电话: 0755-23304126 传真: 0755-29940187

-TOLERANCES- UNLESS OTHERWISE SPECIFIED 公差参数表		 		TITLE: 产品名称: 1.25mm (C型)条形连接器立贴式			
X.X	± 0.30	X.X*	$\pm 3^{\circ}$	APPD: 核准:		PART NO: 产品编号: 1.25-C-nPB	
X.XX	± 0.20	X.XX*	$\pm 2^{\circ}$	CHECK: 校对: 王建业	DATE	SCALE	UNIT
X.XXX	± 0.10	X.XXX*	$\pm 1^{\circ}$	DRAW: 绘图: 黄艳兰	2016-03-12	1:1	mm
							CODE NUMBER A001

X-ON Electronics

Largest Supplier of Electrical and Electronic Components

Click to view similar products for [Headers & Wire Housings](#) category:

Click to view products by [HDGC](#) manufacturer:

Other Similar products are found below :

[0015917161](#) [0022155065](#) [57102-F02-18ULF](#) [58102-G61-06LF](#) [582553-1](#) [01.001.5753.1](#) [0050291907](#) [02.125.8002.8](#) [609-3404](#) [61062-3](#)
[CSU011177004](#) [622-0430](#) [622-3653LF](#) [63453-116](#) [636-1030](#) [636-1427](#) [636-3427](#) [636-4007](#) [641938-9](#) [65495-038](#) [65692-001LF](#) [65781-018](#)
[65781-047](#) [65817-010LF](#) [65817-015LF](#) [67095-007LF](#) [67601157](#) [68631-112](#) [68645-018](#) [699319-000](#) [70.362.1628.0](#) [70-4210](#) [70-4226B](#) [70-](#)
[4853B](#) [71.350.2428.0](#) [733-134](#) [733-162](#) [760-3052](#) [MHR-64-VUAL](#) [80.063.4001.1](#) [800-90-001-10-001000](#) [801-43-002-10-013000](#)
[801-43-006-10-002000](#) [803-43-024-10-001000](#) [803-93-012-10-001000](#) [8-1437020-4](#) [819-22-004-30-001101](#) [820-22-006-30-001101](#)
[820-22-008-30-001101](#) [821-22-002-10-001101](#)