

修 订 NO	标 记 MARK	修 改 描 述 REVISION DESCRIPTION	签 名 SIGNATURE	日 期 DATE
		NEW DWG		2016-03-12

性能:

额定电流: 1A
 额定电压: 100V
 耐电压: 500V
 接触电阻: $\leq 20m\Omega$
 绝缘电阻: 500M Ω
 工作温度: $-20^{\circ}C \sim +85^{\circ}C$

塑件(材质): LCP, UL94V-0
 插簧(材质): 黄铜, 镀锡
 焊片(材质): 磷青铜, 镀锡

孔位	A	B	C
2	2.00	8.00	4.80
3	4.00	10.00	6.80
4	6.00	12.00	8.80
5	8.00	14.00	10.80
6	10.00	16.00	12.80
7	12.00	18.00	14.80
8	14.00	20.00	16.80
9	16.00	22.00	18.80
10	18.00	24.00	20.80
11	20.00	26.00	22.80
12	22.00	28.00	24.80

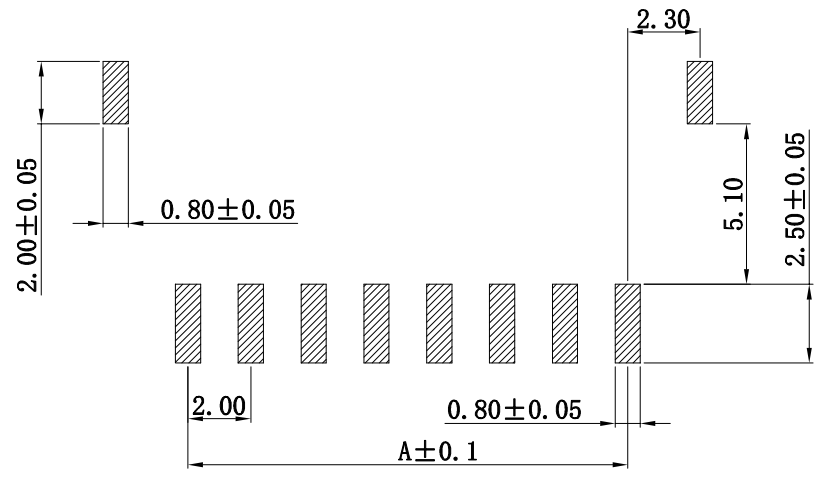
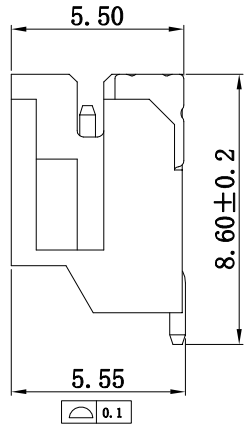
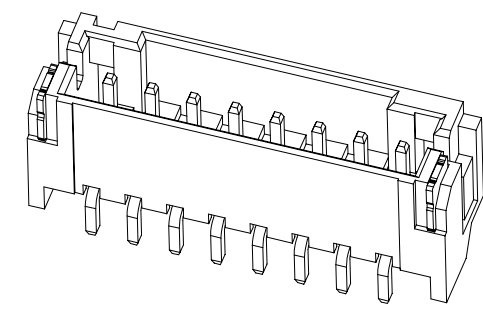
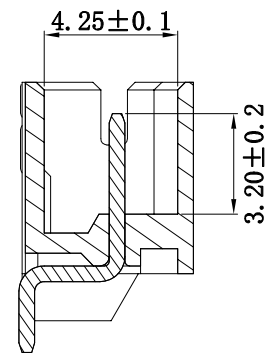
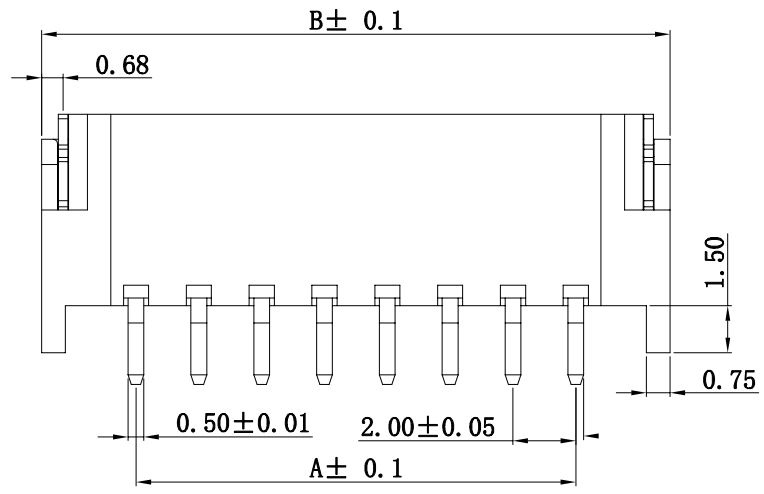
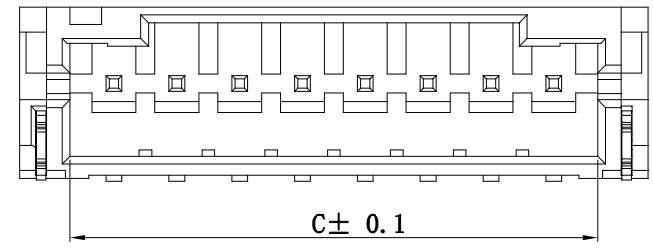

PCB LAYOUT



深圳市华德共创科技有限公司
 Shenzhen Huade co-create Technology Co., LTD
 电话: 0755-23304126 传真: 0755-29940187

-TOLERANCES- UNLESS OTHERWISE SPECIFIED 公差参数表		 	TITLE: 产品名称: 2.0 卧贴/wafer				
X.X	± 0.30	X.X*	$\pm 3^{\circ}$	PART NO: 产品编号: 2.0-A-nPWB			
X.XX	± 0.20	X.XX*	$\pm 2^{\circ}$	DATE	SCALE	UNIT	CODE NUMBER
X.XXX	± 0.10	X.XXX*	$\pm 1^{\circ}$	2016-03-12	1:1	mm	A001

X-ON Electronics

Largest Supplier of Electrical and Electronic Components

Click to view similar products for [Headers & Wire Housings](#) category:

Click to view products by [HDGC](#) manufacturer:

Other Similar products are found below :

[57102-F02-18ULF](#) [58102-G61-06LF](#) [582553-1](#) [009176003701906](#) [01.001.5753.1](#) [0050291907](#) [02.125.8002.8](#) [609-3404](#) [61062-3](#)
[CSU011177004](#) [622-0430](#) [622-3653LF](#) [63453-116](#) [636-1030](#) [636-1427](#) [636-3427](#) [636-4007](#) [641938-9](#) [65495-038](#) [65692-001LF](#) [65781-018](#)
[65781-047](#) [65817-010LF](#) [65817-015LF](#) [66207-023LF](#) [67095-007LF](#) [67601157](#) [68631-112](#) [68645-018](#) [699319-000](#) [M90C108951C](#)
[70.362.1628.0](#) [70-4210](#) [70-4226B](#) [70-4853B](#) [707-5028](#) [71.350.2428.0](#) [71961-016LF](#) [733-134](#) [733-162](#) [754199-000](#) [760-3052](#) [80.063.4001.1](#)
[800-90-001-10-001000](#) [800-90-010-10-002000](#) [801-43-002-10-013000](#) [801-43-006-10-002000](#) [803-41-018-10-001000](#) [803-43-024-10-](#)
[001000](#) [803-93-012-10-001000](#)