

修 订	标 记	修 改 描 要	签 名	日 期
REV NO		REVISION DESCRIPTION	SIGNATURE	DATE
		NEW DRG		2016-03-12

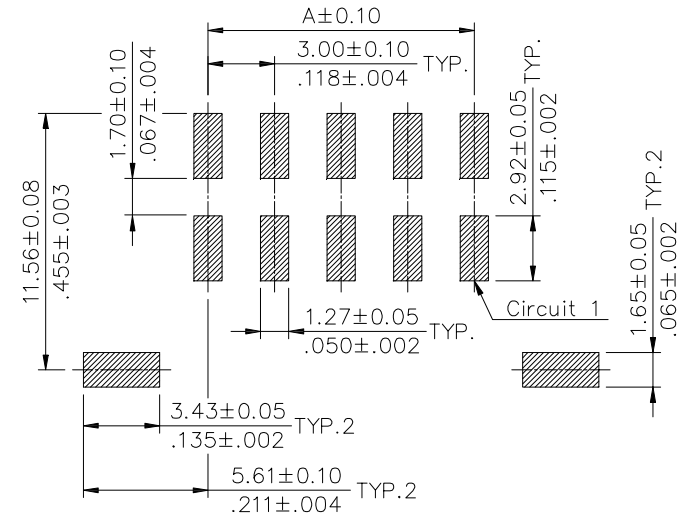

Recommended P.C. Board Layout

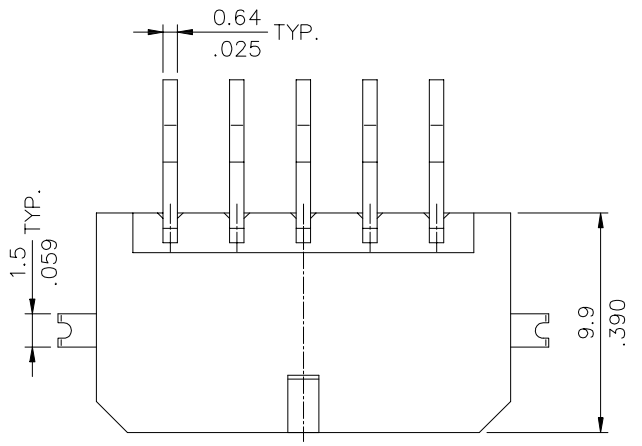
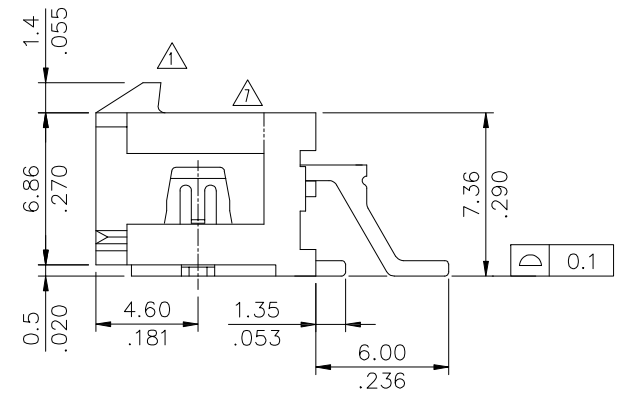
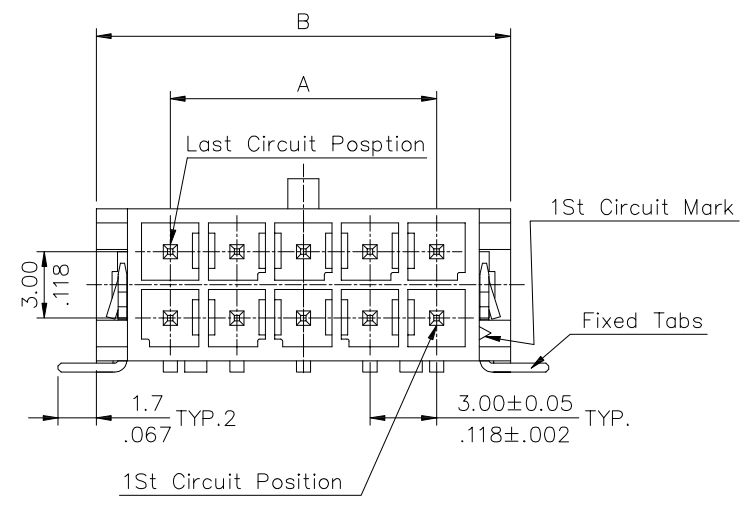

**SPECIFICATIONS**  
 Current Rating: 5A AC,DC  
 Voltage Rating: 250V AC,DC  
 Temperature Range: -25°C ~ +85°C  
 Contact Resistance: 10mΩ Max  
 Insulation Resistance: 1000MΩ Min  
 Withstanding Voltage: 1500V AC/minute  
 Pin Material: Brass/Tin-plated  
 Material: LCP,UL94V-0  
 Color: Natural(Gray)



CIRCUITS	DIM. A	DIM. B
2		6.7(.264)
4	3.00(.118)	9.7(.382)
6	6.00(.236)	12.7(.500)
8	9.00(.354)	15.7(.618)
10	12.00(.472)	18.7(.736)
12	15.00(.591)	21.7(.854)
14	18.00(.709)	24.7(.972)
16	21.00(.827)	27.7(1.091)
18	24.00(.945)	30.7(1.209)
20	27.00(1.063)	33.7(1.327)
22	30.00(1.181)	36.7(1.445)
24	33.00(1.299)	39.7(1.563)



**深圳市华德共创科技有限公司**  
 Shenzhen Huade co-create Technology Co.,LTD  
 电话: 0755-23304126 传真: 0755-29940187

-TOLERANCES- UNLESS OTHERWISE SPECIFIED 公差参数表		 	TITLE: 产品名称: <b>MX3.0双排卧贴</b>			
X.X ±0.30	X.X* ±3°	APPD: 核准:	PART NO: 产品编号: <b>C3030WR-2XnP</b>			
X.XX ±0.20	X.XX* ±2°	CHECK: 校对: 王建业	DATE	SCALE	UNIT	CODE NUMBER
X.XXX ±0.10	X.XXX* ±1°	DRAW: 绘图: 黄艳兰	2016-03-12	1:1	mm	A001

## X-ON Electronics

Largest Supplier of Electrical and Electronic Components

*Click to view similar products for [Headers & Wire Housings](#) category:*

*Click to view products by [HDGC](#) manufacturer:*

Other Similar products are found below :

[57102-F02-18ULF](#) [58102-G61-06LF](#) [0009485154](#) [009176003701906](#) [0050291907](#) [00-9021-0611-00-339](#) [02.125.8002.8](#) [609-3404](#) [61062-3](#)  
[622-0430](#) [622-3653LF](#) [63453-116](#) [636-1030](#) [636-1427](#) [636-3427](#) [636-4007](#) [641938-9](#) [644827-2](#) [65495-038](#) [65692-001LF](#) [65781-018](#)  
[65781-047](#) [65817-010LF](#) [65817-015LF](#) [66207-023LF](#) [67016-026LF](#) [67095-007LF](#) [68631-112](#) [68645-018](#) [68648-049](#) [699319-000](#)  
[70.362.1628.0](#) [70-4210](#) [70-4226B](#) [70-4853B](#) [707-5020](#) [707-5028](#) [71.350.2428.0](#) [71961-016LF](#) [733-134](#) [754199-000](#) [760-3052](#) [787-8014-00](#)  
[FCN-367T-T012/H](#) [80.063.4001.1](#) [800-90-001-10-001000](#) [800-90-010-10-002000](#) [801-43-002-10-013000](#) [801-43-006-10-002000](#)  
[803-41-018-10-001000](#)