

修 订	标 记	修 改 描 要	签 名	日 期
REV	MARK	REVISION DESCRIPTION	SIGNATURE	DATE
AO		NEW DWG		2016-03-12

NOTE:



一、 MATERIALS:

1. Housing: PBT BLACK.
2. Cover: PA66 BLACK.
3. Contacts: Brass
4. Shell: SPCC
5. Board Lock: SPCC
6. Rivet: Copper Alloy
7. Screw: SPCC

二、 FINISH:

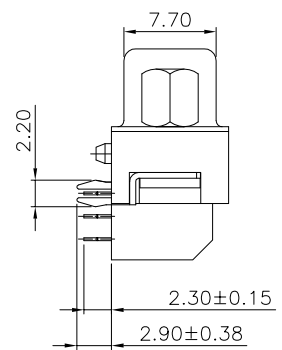
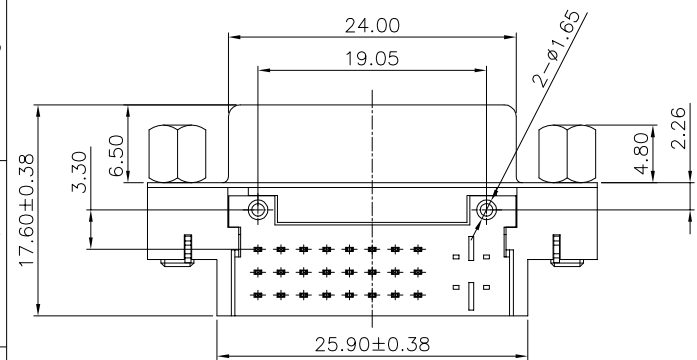
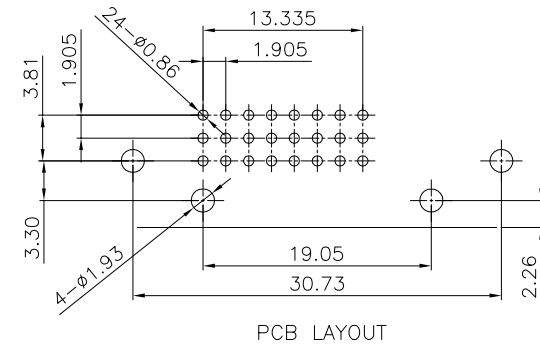
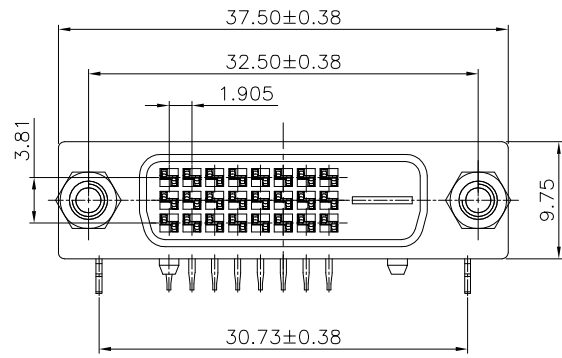
1. Contacts: Gold Plated on Contact Area
Sn Plated on Solderails
Nickel Under Plated Over All
2. Shell: Black Nickel Plated
3. Board Lock: Sn Plated
4. Rivet: Nickel Plated
5. Screw: Nickel Plated



		深圳市华德共创科技有限公司 Shenzhen Huade co-create Technology Co.,LTD 电话: 0755-23304126 传真: 0755-29940187						
-TOLERANCES- UNLESS OTHERWISE SPECIFIED 公差参数表				 		TITLE: 产品名称: DVI 24+1母座带螺丝4.8		
X.X	±0.30	X.X*	±3°	APPD: 核准:	PART NO: 产品编号: DVI-HX-102DIP			
X.XX	±0.20	X.XX*	±2°	CHECK: 校对: 王建业	DATE	SCALE	UNIT	CODE NUMBER
X.XXX	±0.10	X.XXX*	±1°	DRAW: 绘图: 黄艳兰	2016-03-12	1:1	mm	A001

X-ON Electronics

Largest Supplier of Electrical and Electronic Components

Click to view similar products for [HDMI, Displayport & DVI Connectors](#) category:

Click to view products by [HDGC](#) manufacturer:

Other Similar products are found below :

[30-528](#) [30-504](#) [33DVIR-24S1B](#) [47648-2000](#) [TC142X](#) [1932649-1](#) [HAGBH](#) [AABII](#) [ABIBG](#) [AAIBH](#) [52355](#) [XHLJQ-00026](#) [HDMI-019R](#)
[G46M2013201AWEU](#) [ST-0277D00-052-142](#) [HC-PJ-320A-3P-D](#) [HC-PJ-3133-5P-D](#) [PJ-342](#) [141](#) [PJ-320A-4P DIP](#) [HC-PJ-325C-5P](#) [HC-PJ-](#)
[320D-4P-S](#) [HC-PJ-3133-6P-S](#) [D-SUB-DR-9PCM-CB](#) [ST-0275S00-082-182](#) [HC-PJ-320A-4P-D](#) [HC-PJ-325A-5P](#) [HC-PJ-3134-6P-D](#) [HDR-](#)
[HX-102DIP](#) [HDMI-GD-121PWB](#) [C2939191](#) [C2939584](#) [PJ-208](#) [PJ-2040](#) [PJ-3580A-6A](#) [PJ-399M](#) [PJ-3200A-3A](#) [PJ-328B-4B](#) [PJ-3930-7A](#)
[PJ-615-5A](#) [PJ-332-6A](#) [KH-HDMI-0001](#) [KH-PJ-209-SMT](#) [KH-HDMI-0035-XK](#) [KH-PJ-328A-5P](#) [KH-PJ-322](#) [KH-PJ-327E-SMT](#) [KH-PJ-](#)
[320A-5.6](#) [KH-HDR15P-F3.08](#) [KH-HDMI-0005A-SMT](#) [KH-HDMI-0021-JBS](#)