

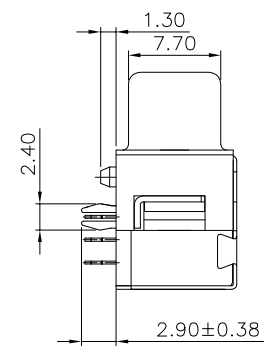

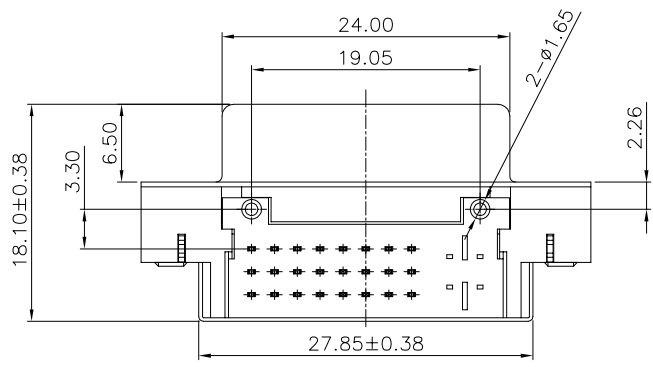

修改		标记	修改摘要	签名	日期
REV	NO	MARK	REVISION DESCRIPTION	SIGNATURE	DATE
			NEW DWG		2016-03-12

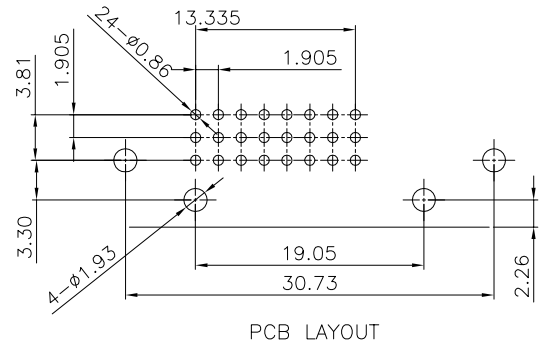
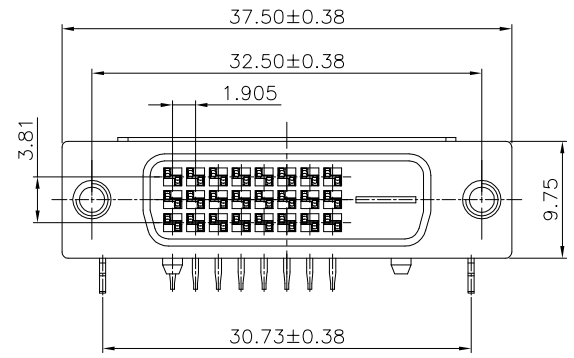

NOTE:

- 一、MATERIALS:
- Housing: SEE PART NO. Color: SEE PART NO.
 - Cover: SEE PART NO. Color: SEE PART NO.
 - Contacts: Brass
 - Shell: SPCC
 - Board Lock: SPCC
 - Rivet: Copper Alloy
 - Screw: SPCC Or Copper Alloy
- 二、FINISH:
- Contacts: Gold Plated on Contact Area
Sn Plated on Solderails
Nickel Under Plated Over All
 - Shell: Nickel Plated
 - Board Lock: Sn Plated
 - Rivet: Nickel Plated
 - Screw: Nickel Plated

		深圳市华德共创科技有限公司 Shenzhen Huade co-create Technology Co.,LTD 电话: 0755-23304126 传真: 0755-29940187						
-TOLERANCES- UNLESS OTHERWISE SPECIFIED 公差参数表				 		TITLE: 产品名称: DVI24+1母座铆合不带螺丝带屏蔽壳		
X.X	±0.30	X.X*	±3°	APPD: 核准:	PART NO: 产品编号: DVI-HX-106DIP			
X.XX	±0.20	X.XX*	±2°	CHECK: 校对: 王建业	DATE	SCALE	UNIT	CODE NUMBER
X.XXX	±0.10	X.XXX*	±1°	DRAW: 绘图: 黄艳兰	2016-03-12	1:1	mm	A001

X-ON Electronics

Largest Supplier of Electrical and Electronic Components

Click to view similar products for [HDMI, Displayport & DVI Connectors](#) category:

Click to view products by [HDGC manufacturer](#):

Other Similar products are found below :

[30-1231](#) [30-528](#) [30-504](#) [30-519](#) [33DVIR-24S1B](#) [47648-2000](#) [2002-400](#) [TC142X](#) [769-103/021-000](#) [1932649-1](#) [CP30200GM3](#) [67881](#)
[HAFBF](#) [HBLBH](#) [HBLBI](#) [HAFBG](#) [HAFBH](#) [HAGBF](#) [HAGBG](#) [HAGBI](#) [HAGBJ](#) [HBLBJ](#) [AABIE](#) [AABIF](#) [AABIG](#) [AABIH](#) [AABII](#) [AABIJ](#)
[AABIK](#) [AABIL](#) [AACBE](#) [AACBF](#) [AACBG](#) [ABIBF](#) [ABIBG](#) [ABIBH](#) [42154](#) [AACBH](#) [AACBI](#) [AACBJ](#) [AACBK](#) [AACBL](#) [AAIBD](#) [AAIBF](#)
[AAIBH](#) [AAIBI](#) [AANBF](#) [AANBG](#) [AANBH](#) [AANBI](#)