

修订 REV	标记 MARK	修改摘要 REVISION DESCRIPTION	签名 SIGNATURE	日期 DATE
AO		NEW RELEASE	黄艳兰	2020-12-12

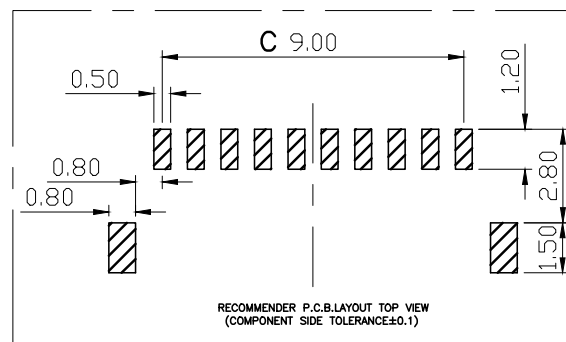
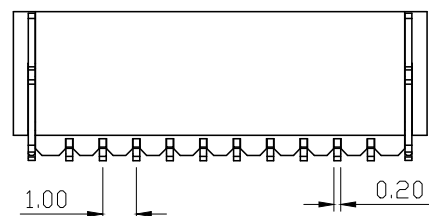
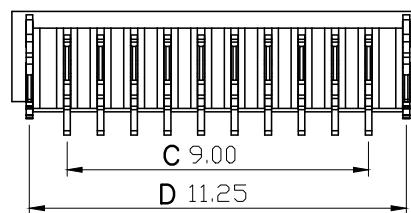
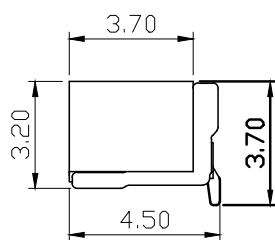
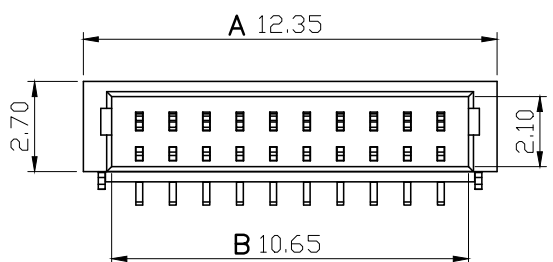
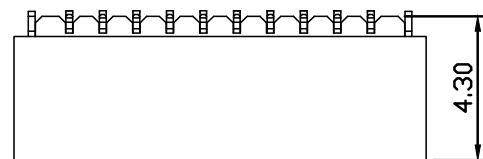
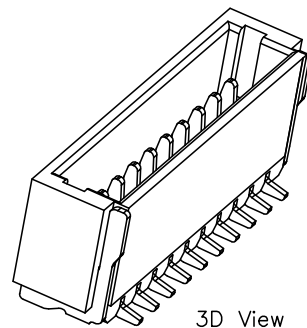

PIN数	A±0.1	B±0.1	C±0.1	D±0.1
2P	4.35	2.65	1.00	3.25
3P	5.35	3.65	2.00	4.25
4P	6.35	4.65	3.00	5.25
5P	7.35	5.65	4.00	6.25
6P	8.35	6.65	5.00	7.25
7P	9.35	7.65	6.00	8.25
8P	10.35	8.65	7.00	9.25
9P	11.35	9.65	8.00	10.25
10P	12.35	10.65	9.00	11.25

3	插片	黄铜H65	镀镍锡	
2	插针	黄铜H65	镀镍锡	
1	基座	LCP	本色	
序号	品名	材质	电镀/颜色	备注

Specifications:

- 1.Rated Voltage : 50V AC/DC
- 2.Rated Current : 1A AC,DC
- 3.Withstand Voltage : 200V AC/minute
- 4.Contact Resistance : 50mΩ(MAX.)
- 5.Insulation Resistance : 100MΩ(MIN.)
- 6.Storage Temperature Range:-40°C~+85°C;
- 7.Operation Temperature Range:-25°C~+70°C;

HDGC 深圳市华德共创科技有限公司
Shenzhen Huade co-create Technology Co.,LTD
TEL : 0755-27129737 FAX : 0755-29940187

-TOLERANCES- UNLESS OTHERWISE SPECIFIED 公差参数表				TITLE: 产品名称: SH1.0针座立贴	
X.X	±0.30	X.X°	±3°	APPD: 核准: 谢亮	PART NO: 产品编号: HDGC1002WV-S-XP
X.XX	±0.30	X.XX°	±2°	CHECK: 校对: 王建业	DATE
X.XXX	±0.10	X.XXX°	±1°	DRAW: 绘图: 黄艳兰	SCALE
					UNIT
					CODE NUMBER
					A070

X-ON Electronics

Largest Supplier of Electrical and Electronic Components

Click to view similar products for [Headers & Wire Housings](#) category:

Click to view products by [HDGC](#) manufacturer:

Other Similar products are found below :

[57102-F02-18ULF](#) [58102-G61-06LF](#) [582553-1](#) [0009485154](#) [009176003701906](#) [0050291907](#) [02.125.8002.8](#) [609-3404](#) [61062-3](#) [622-0430](#)
[622-3653LF](#) [63453-116](#) [636-1030](#) [636-1427](#) [636-3427](#) [636-4007](#) [641938-9](#) [65495-038](#) [65692-001LF](#) [65781-018](#) [65781-047](#) [65817-015LF](#)
[66207-023LF](#) [67016-026LF](#) [67095-007LF](#) [68631-112](#) [68645-018](#) [68648-049](#) [699319-000](#) [M90C108951C](#) [70.362.1628.0](#) [70-4210](#) [70-4226B](#)
[70-4853B](#) [707-5020](#) [707-5028](#) [71.350.2428.0](#) [71961-016LF](#) [733-134](#) [754199-000](#) [760-3052](#) [787-8014-00](#) [FCN-367T-T012/H](#)
[80.063.4001.1](#) [800-90-001-10-001000](#) [801-43-002-10-013000](#) [801-43-006-10-002000](#) [803-41-018-10-001000](#) [803-43-014-20-001000](#)
[803-43-024-10-001000](#)