

修订 REV	标记 MARK	修改摘要 REVISION DESCRIPTION	签名 SIGNATURE	日期 DATE
AO		NEW RELEASE	黄艳兰	2021-05-09

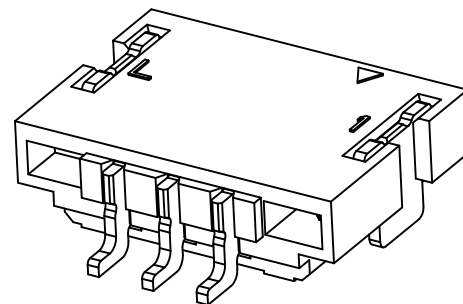

Specifications:

Contact resistance:  $\leq 20m\Omega$   
 Insulation resistance:  $\geq 100M\Omega$   
 Rated voltage: 50V AC DC  
 Rated current: 1.0A AC DC  
 Withstand Voltage: 500V AC/minute  
 Temperature Range:  $-25^{\circ}C \sim +85^{\circ}C$   
 Housing: PA6T UL94V-0, Natural (Beige)  
 Contacts: Phosphor bronze/Matte Sn  
 Solder Tabs: Phosphor bronze/Matte Sn

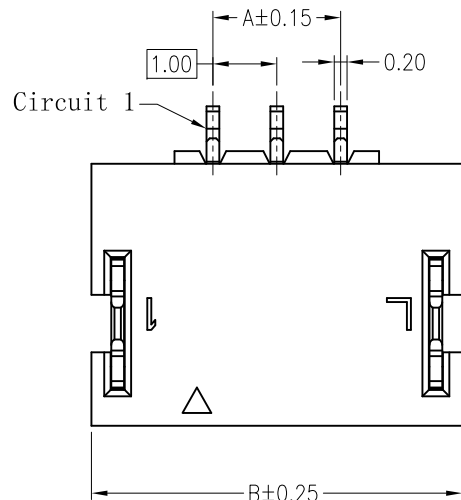
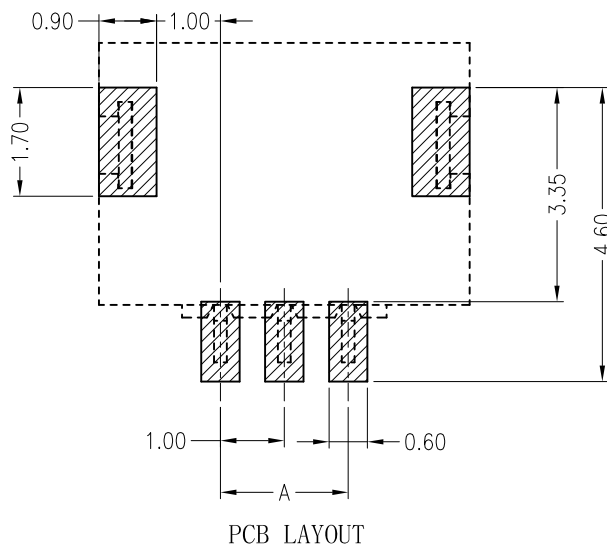
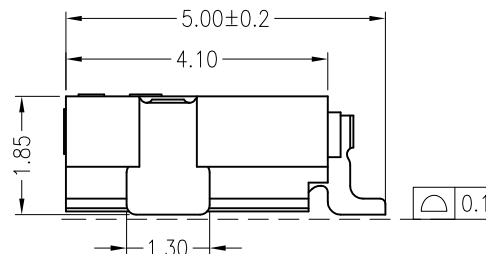
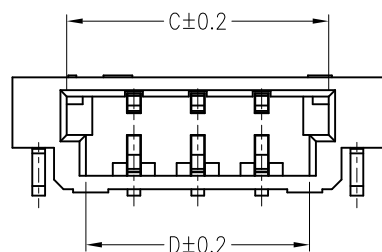

Circuits	Dimensions (mm)				Circuits	Dimensions (mm)			
	A	B	C	D		A	B	C	D
02	1.00	4.80	3.10	2.50	*17	16.00	19.80	18.10	17.50
03	2.00	5.80	4.10	3.50	*18	17.00	20.80	19.10	18.50
04	3.00	6.80	5.10	4.50	*19	18.00	21.80	20.10	19.50
05	4.00	7.80	6.10	5.50	*20	19.00	22.80	21.10	20.50
06	5.00	8.80	7.10	6.50	*21	20.00	23.80	22.10	21.50
07	6.00	9.80	8.10	7.50	*22	21.00	24.80	23.10	22.50
08	7.00	10.80	9.10	8.50	*23	22.00	25.80	24.10	23.50
*09	8.00	11.80	10.10	9.50	*24	23.00	26.80	25.10	24.50
*10	9.00	12.80	11.10	10.50	*25	24.00	27.80	26.10	25.50
*11	10.00	13.80	12.10	11.50	*26	25.00	28.80	27.10	26.50
*12	11.00	14.80	13.10	12.50	*27	26.00	29.80	28.10	27.50
*13	12.00	15.80	14.10	13.50	*28	27.00	30.80	29.10	28.50
*14	13.00	16.80	15.10	14.50	*29	28.00	31.80	30.10	29.50
*15	14.00	17.80	16.10	15.50	*30	29.00	32.80	31.10	30.50
*16	15.00	18.80	17.10	16.50					



**深圳市华德共创科技有限公司**  
 Shenzhen Huade co-create Technology Co.,LTD  
 TEL : 0755-27111225 FAX : 0755-29940187

-TOLERANCES- UNLESS OTHERWISE SPECIFIED 公差参数表						TITLE: 产品名称: SHLP1.0卧贴			
X.X	$\pm 0.30$	X.X°	$\pm 3^{\circ}$	APPD: 核准:	谢亮	PART NO: 产品编号: HDGC1006WR-S-XP			
X.XX	$\pm 0.30$	X.XX°	$\pm 2^{\circ}$	CHECK: 校对:	王建业	DATE	SCALE	UNIT	CODE NUMBER
X.XXX	$\pm 0.10$	X.XXX°	$\pm 1^{\circ}$	DRAW: 绘图:	黄艳兰	2021-05-09	1:1	mm	A018

## X-ON Electronics

Largest Supplier of Electrical and Electronic Components

*Click to view similar products for [Headers & Wire Housings](#) category:*

*Click to view products by [HDGC](#) manufacturer:*

Other Similar products are found below :

[57102-F02-18ULF](#) [58102-G61-06LF](#) [582553-1](#) [009176003701906](#) [01.001.5753.1](#) [0050291907](#) [02.125.8002.8](#) [609-3404](#) [61062-3](#)  
[CSU011177004](#) [622-0430](#) [622-3653LF](#) [63453-116](#) [636-1030](#) [636-1427](#) [636-3427](#) [636-4007](#) [641938-9](#) [65495-038](#) [65692-001LF](#) [65781-018](#)  
[65781-047](#) [65817-010LF](#) [65817-015LF](#) [66207-023LF](#) [67095-007LF](#) [67601157](#) [68631-112](#) [68645-018](#) [699319-000](#) [M90C108951C](#)  
[70.362.1628.0](#) [70-4210](#) [70-4226B](#) [70-4853B](#) [707-5028](#) [71.350.2428.0](#) [71961-016LF](#) [733-134](#) [733-162](#) [754199-000](#) [760-3052](#) [80.063.4001.1](#)  
[800-90-001-10-001000](#) [800-90-010-10-002000](#) [801-43-002-10-013000](#) [801-43-006-10-002000](#) [803-41-018-10-001000](#) [803-43-024-10-](#)  
[001000](#) [803-93-012-10-001000](#)