

修订 REV	标记 MARK	修改摘要 REVISION DESCRIPTION	签名 SIGNATURE	日期 DATE
AO		NEW RELEASE	WANG	2012-12-10

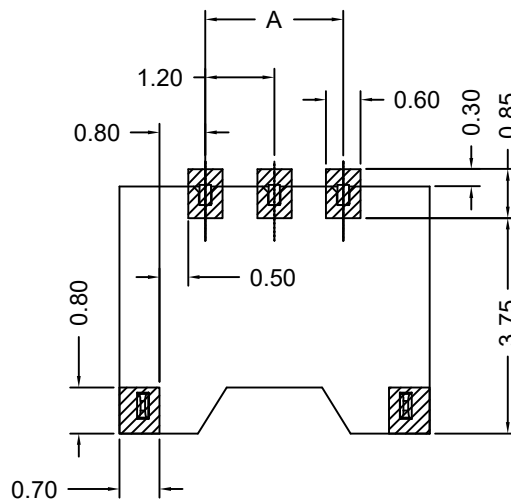

RECOMMENDED PCB LAYOUT
GENERAL TOLERANCE ±0.05

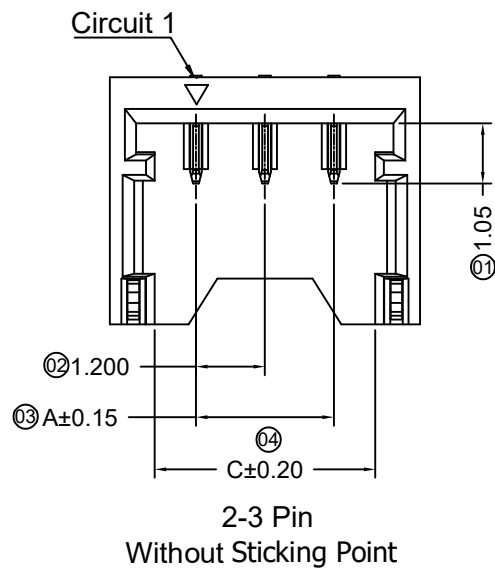
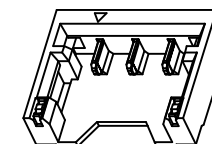

3D View

■ Specification

- Voltage Rating : 50V AC/DC
- Current Rating : 2A AC/DC
- Withstanding Voltage : 500V AC /minute
- Insulation Resistance : ≥100MΩ min
- Temperature Range : -40°C to + 105°C
- Contact Resistance : ≤20mΩ
- After Environmental Testing: ≤40mΩ
- Suitable Wire/Cable:AWG #28 to #30,OD:0.8mm max

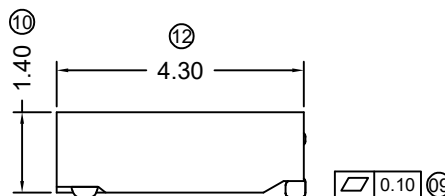
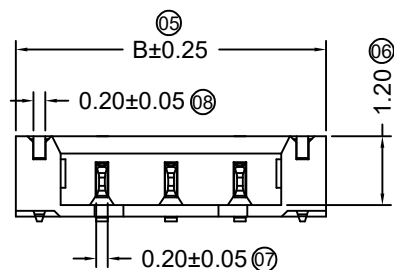

Poles	Dimensions(mm)			Poles	Dimensions(mm)		
	A	B	C		A	B	C
02	1.20	4.20	2.64	03	2.40	5.40	3.84



深圳市华德共创科技有限公司

Shenzhen Huade co-create Technology Co.,LTD

TEL : 0755-27129737 FAX : 0755-29940187

-TOLERANCES- UNLESS OTHERWISE SPECIFIED 公差参数表						TITLE: 产品名称 : MX1.2针座			
X.X	±0.30	X.X°	±3°	APPD: 核准 :	XIE	PART NO: 产品编号 : HDGC1202WR-S-XP			
X.XX	±0.30	X.XX°	±2°	CHECK: 校对 :	WANG	DATE	SCALE	UNIT	CODE NUMBER
X.XXX	±0.10	X.XXX°	±1°	DRAW: 绘图 :	WANG	2012-12-10	1:1	mm	A096

修订 REV	标记 MARK	修改摘要 REVISION DESCRIPTION	签名 SIGNATURE	日期 DATE
AO		NEW RELEASE	WANG	2012-12-10

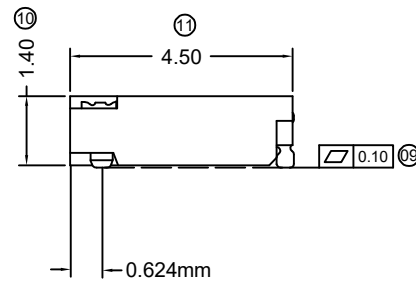
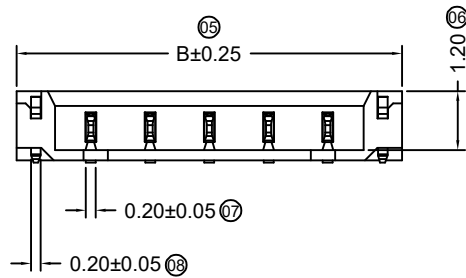
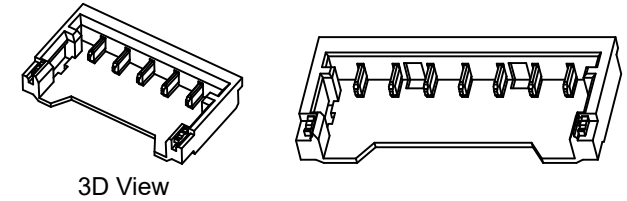
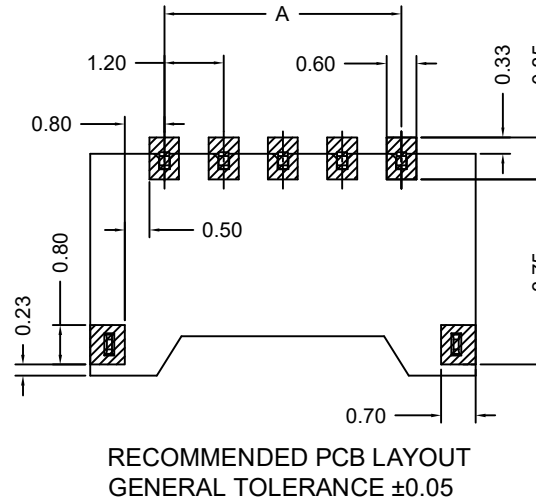
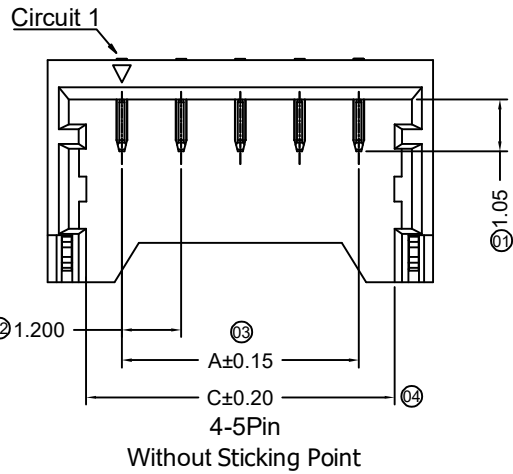

■ Specification

- Voltage Rating : 50V AC/DC
- Current Rating : 2A AC/DC
- Withstanding Voltage : 500V AC /minute
- Insulation Resistance : $\geq 100\text{M}\Omega$ min
- Temperature Range : 40°C to $+105^\circ\text{C}$
- Contact Resistance : $\leq 20\text{m}\Omega$
- After Environmental Testing: $\leq 40\text{m}\Omega$
- Suitable Wire/Cable: AWG #28 to #30, OD: 0.8mm max

Poles	Dimensions(mm)			Poles	Dimensions(mm)		
	A	B	C		A	B	C
04	3.60	6.60	5.04	08	8.40	11.40	9.84
05	4.80	7.80	6.24	09	9.60	12.60	11.04
06	6.00	9.00	7.44	10	10.80	13.80	12.24
07	7.20	10.20	8.64				



深圳市华德共创科技有限公司

Shenzhen Huade co-create Technology Co., LTD
TEL : 0755-27129737 FAX : 0755-29940187

-TOLERANCES- UNLESS OTHERWISE SPECIFIED 公差参数表						TITLE: 产品名称: MX1.2针座			
X.X	± 0.30	X.X°	$\pm 3^\circ$	APPD: 核准:	XIE	PART NO: 产品编号: HDGC1202WR-S-XP			
X.XX	± 0.30	X.XX°	$\pm 2^\circ$	CHECK: 校对:	WANG	DATE	SCALE	UNIT	CODE NUMBER
X.XXX	± 0.10	X.XXX°	$\pm 1^\circ$	DRAW: 绘图:	WANG	2012-12-10	1:1	mm	A096

X-ON Electronics

Largest Supplier of Electrical and Electronic Components

Click to view similar products for [Headers & Wire Housings](#) category:

Click to view products by [HDGC](#) manufacturer:

Other Similar products are found below :

[57102-F02-18ULF](#) [58102-G61-06LF](#) [582553-1](#) [009176003701906](#) [01.001.5753.1](#) [0050291907](#) [02.125.8002.8](#) [609-3404](#) [61062-3](#)
[CSU011177004](#) [622-0430](#) [622-3653LF](#) [63453-116](#) [636-1030](#) [636-1427](#) [636-3427](#) [636-4007](#) [641938-9](#) [65495-038](#) [65692-001LF](#) [65781-018](#)
[65781-047](#) [65817-010LF](#) [65817-015LF](#) [66207-023LF](#) [67095-007LF](#) [67601157](#) [68631-112](#) [699319-000](#) [M90C108951C](#) [70.362.1628.0](#) [70-](#)
[4210](#) [70-4226B](#) [70-4853B](#) [707-5028](#) [71.350.2428.0](#) [71961-016LF](#) [733-134](#) [733-162](#) [754199-000](#) [760-3052](#) [80.063.4001.1](#) [800-90-001-10-](#)
[001000](#) [801-43-002-10-013000](#) [801-43-006-10-002000](#) [803-41-018-10-001000](#) [803-43-024-10-001000](#) [803-93-012-10-001000](#) [8-1437020-4](#)
[819-22-004-30-001101](#)