

修订 REV	标记 MARK	修改摘要 REVISION DESCRIPTION	签名 SIGNATURE	日期 DATE
A0		NEW DWG		2010-05-18

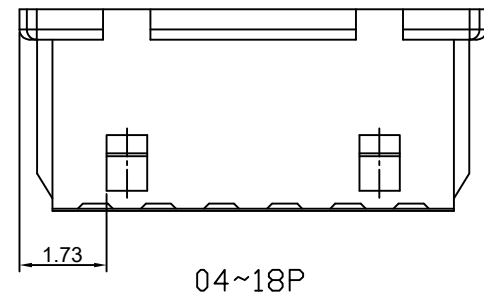
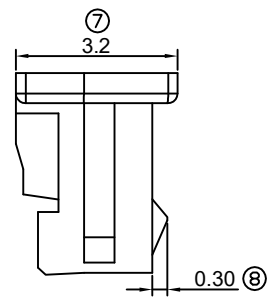
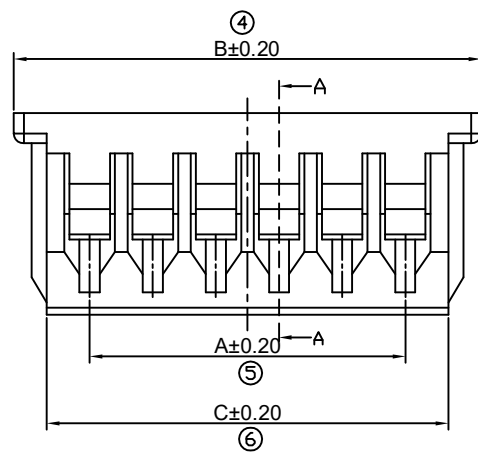
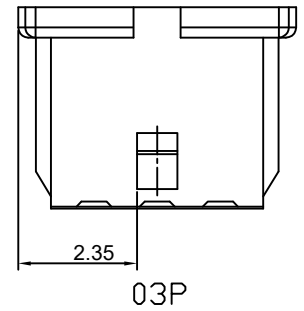
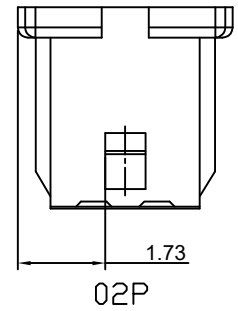
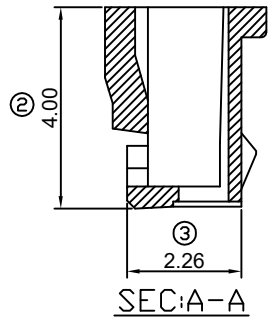
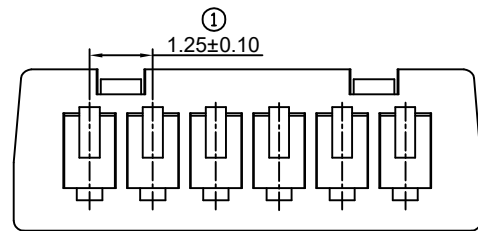

Circuit No.	Dimensions		
	A	B	C
02P	1.25	4.25	2.95
03P	2.50	5.50	4.20
04P	3.75	6.75	5.45
05P	5.00	8.00	6.70
06P	6.25	9.25	7.95
07P	7.50	10.50	9.20
08P	8.75	11.75	10.45
09P	10.00	13.00	11.70
10P	11.25	14.25	12.95
11P	12.50	15.50	14.20
12P	13.75	16.75	15.45
13P	15.00	18.00	16.70
14P	16.25	19.25	17.95
15P	17.50	20.50	19.20
16P	18.75	21.75	20.45
17P	20.00	23.00	21.70
18P	21.25	24.25	22.95

要求:

- 1、材质: PA66白色 UL94-V0;
- 2、外观: 外形无变形、缺胶等不良;
- 3、尺寸: 所有尺寸均符合检测标准;
- 4、包装: 胶袋封装, 最小包装量2K/包。



深圳市华德共创科技有限公司  
Shenzhen Huade co-create Technology Co.,LTD  
电话: 0755-27129737 传真: 0755-29940187

-TOLERANCES- UNLESS OTHERWISE SPECIFIED 公差参数表				TITLE: 产品名称: MX1.25H-NP				
X.X	±0.30	X.X'	±3'	APPD: 核准: 谢亮	PART NO: 产品编号: HDGC1251H-XP			
X.XX	±0.30	X.XX'	±2'	CHECK: 校对: 王建业	DATE	SCALE	UNIT	CODE NUMBER
X.XXX	±0.10	X.XXX'	±1'	DRAW: 绘图: 黄艳兰	2010-05-18	1:1	mm	A001

# 环保物料

修订 REV	标记 MARK	修改摘要 REVISION DESCRIPTION	签名 SIGNATURE	日期 DATE
AO		NEW DWG		2010-11-07

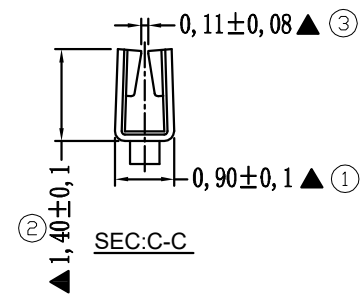
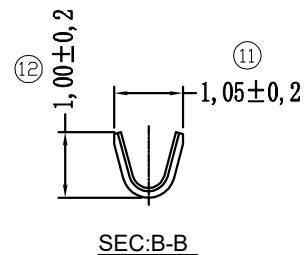
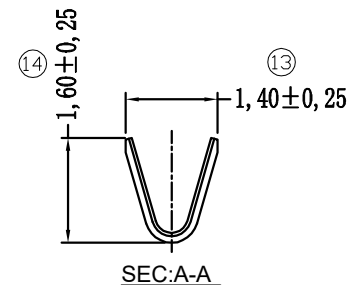
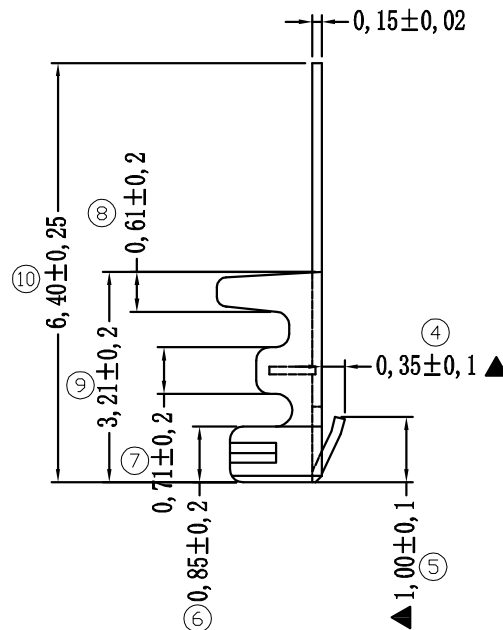
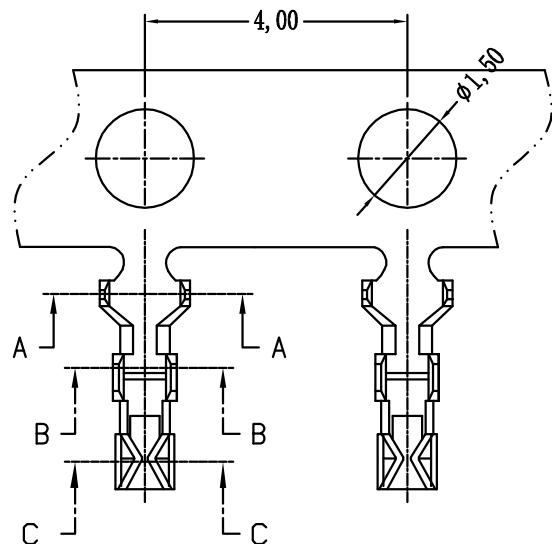

材质要求: 磷铜, C5191; 材厚: T=0.15±0.02

Material	Finish	Wire Range	Insulation O.D	Qty/reel
Phosphor bronze	Tin-plated	AWG#28-#32	1.2~1.05mm	20,000pcs



深圳市华德共创科技有限公司

Shenzhen Huade co-create Technology Co., LTD

电话: 0755-27129737 传真: 0755-29940187

-TOLERANCES- UNLESS OTHERWISE SPECIFIED 公差参数表			TITLE: 产品名称: MX1.25-TER			
X.X ±0.30	X.X' ±3'	APPD: 核准: 谢亮	PART NO: 产品编号: HDGC1251-T			
X.XX ±0.30	X.XX' ±2'	CHECK: 校对: 王建业	DATE	SCALE	UNIT	CODE NUMBER
X.XXX ±0.10	X.XXX' ±1'	DRAW: 绘图: 黄艳兰	2010-11-07	1:1	mm	A001

## X-ON Electronics

Largest Supplier of Electrical and Electronic Components

*Click to view similar products for [Headers & Wire Housings](#) category:*

*Click to view products by [HDGC](#) manufacturer:*

Other Similar products are found below :

[57102-F02-18ULF](#) [58102-G61-06LF](#) [582553-1](#) [009176003701906](#) [01.001.5753.1](#) [0050291907](#) [02.125.8002.8](#) [609-3404](#) [61062-3](#)  
[CSU011177004](#) [622-0430](#) [622-3653LF](#) [63453-116](#) [636-1030](#) [636-1427](#) [636-3427](#) [636-4007](#) [641938-9](#) [65495-038](#) [65692-001LF](#) [65781-018](#)  
[65781-047](#) [65817-010LF](#) [65817-015LF](#) [66207-023LF](#) [67095-007LF](#) [67601157](#) [68631-112](#) [699319-000](#) [M90C108951C](#) [70.362.1628.0](#) [70-](#)  
[4210](#) [70-4226B](#) [70-4853B](#) [707-5028](#) [71.350.2428.0](#) [71961-016LF](#) [733-134](#) [733-162](#) [754199-000](#) [760-3052](#) [80.063.4001.1](#) [800-90-001-10-](#)  
[001000](#) [801-43-002-10-013000](#) [801-43-006-10-002000](#) [803-41-018-10-001000](#) [803-43-024-10-001000](#) [803-93-012-10-001000](#) [8-1437020-4](#)  
[819-22-004-30-001101](#)