

修订 REV	标记 MARK	修改摘要 REVISION DESCRIPTION	签名 SIGNATURE	日期 DATE
AO		NEW RELEASE	黄艳兰	2021-01-07

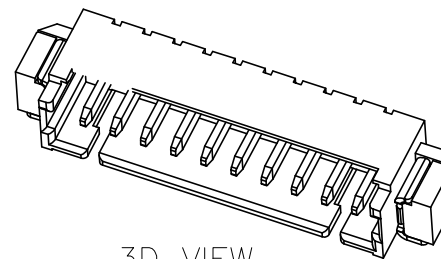

3D VIEW

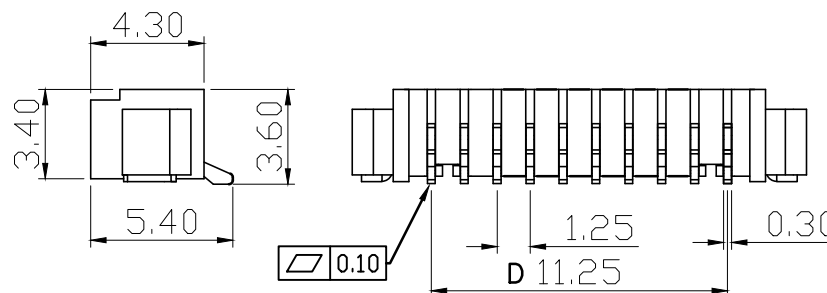
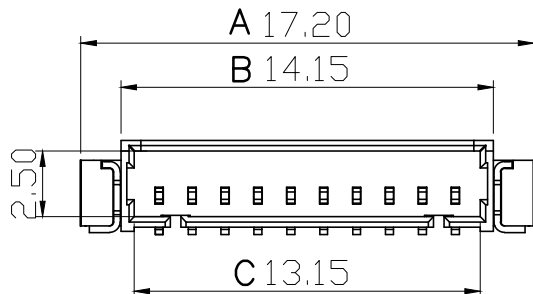

PIN数	A±0.1	B±0.1	C±0.1	D±0.1
2P	7.20	4.35	3.15	1.25
3P	8.45	5.40	4.40	2.50
4P	9.70	6.65	5.65	3.75
5P	10.95	7.90	6.90	5.00
6P	12.20	9.15	8.15	6.25
7P	13.45	10.40	9.40	7.50
8P	14.70	11.65	10.65	8.75
9P	15.95	12.90	11.90	10.00
10P	17.20	14.15	13.15	11.25

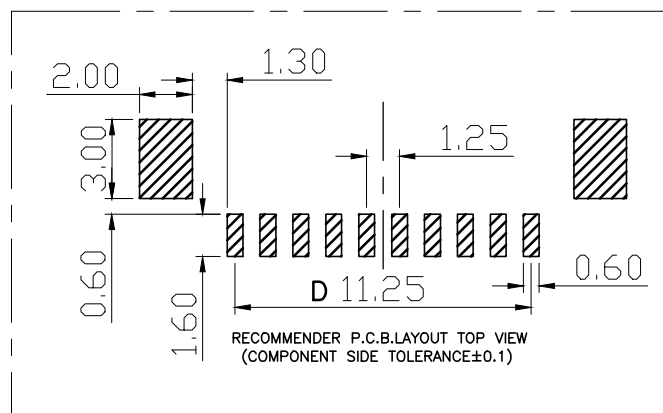

C	插片	黄铜H65	镀镍锡	
B	插针	黄铜H65	镀镍锡	
A	基座	LCP	本色	
序号	品名	材质	电镀/颜色	备注

Specifications:

1. Rated Voltage : 125V AC/DC
2. Rated Current : 1A AC,DC
3. Withstand Voltage : 200V AC/minute
4. Contact Resistance : 50mΩ(MAX.)
5. Insulation Resistance : 100MΩ(MIN.)
6. Storage Temperature Range: -40°C~+85°C;
7. Operation Temperature Range: -25°C~+70°C;



深圳市华德共创科技有限公司

Shenzhen Huade co-create Technology Co.,LTD  
TEL : 0755-27129737 FAX : 0755-29940187

-TOLERANCES- UNLESS OTHERWISE SPECIFIED 公差参数表				TITLE: 产品名称: MX1.25针座卧贴	
X.X	±0.30	X.X°	±3°	APPD: 核准: 谢亮	PART NO: 产品编号: HDGC1251WR-S-XP
X.XX	±0.30	X.XX°	±2°	CHECK: 校对: 王建业	DATE
X.XXX	±0.10	X.XXX°	±1°	DRAW: 绘图: 黄艳兰	SCALE
					UNIT
					CODE NUMBER
					A070

## X-ON Electronics

Largest Supplier of Electrical and Electronic Components

*Click to view similar products for [Headers & Wire Housings](#) category:*

*Click to view products by [HDGC](#) manufacturer:*

Other Similar products are found below :

[57102-F02-18ULF](#) [58102-G61-06LF](#) [0009485154](#) [009176003701906](#) [0050291907](#) [00-9021-0611-00-339](#) [02.125.8002.8](#) [609-3404](#) [61062-3](#)  
[622-0430](#) [622-3653LF](#) [63453-116](#) [636-1030](#) [636-1427](#) [636-3427](#) [636-4007](#) [641938-9](#) [644827-2](#) [65495-038](#) [65692-001LF](#) [65781-018](#)  
[65781-047](#) [65817-010LF](#) [65817-015LF](#) [66207-023LF](#) [67016-026LF](#) [67095-007LF](#) [68631-112](#) [68645-018](#) [68648-049](#) [699319-000](#)  
[70.362.1628.0](#) [70-4210](#) [70-4226B](#) [70-4853B](#) [707-5020](#) [707-5028](#) [71.350.2428.0](#) [71961-016LF](#) [733-134](#) [754199-000](#) [760-3052](#) [787-8014-00](#)  
[FCN-367T-T012/H](#) [80.063.4001.1](#) [800-90-001-10-001000](#) [800-90-010-10-002000](#) [801-43-002-10-013000](#) [801-43-006-10-002000](#)  
[803-41-018-10-001000](#)